

# SMART Board® iv2

## interactive whiteboard system

SB480iv2 AND SBM680Viv2

**CONFIGURATION AND USER'S GUIDE**

**SMART®**

**FCC warning**

This equipment has been tested and found to comply with the limits for a Class A digital device, pursuant to Part 15 of the FCC Rules. These limits are designed to provide reasonable protection against harmful interference when the equipment is operated in a commercial environment. This equipment generates, uses and can radiate radio frequency energy and, if not installed and used in accordance with the manufacturer's instructions, may cause harmful interference to radio communications. Operation of this equipment in a residential area is likely to cause harmful interference in which case the user will be required to correct the interference at his own expense.

**Trademark notice**

SMART Board, SMART Notebook, smarttech, DViT, the SMART logo and all SMART taglines are trademarks or registered trademarks of SMART Technologies ULC in the U.S. and/or other countries. BrilliantColor, DLP and Texas Instruments are trademarks of Texas Instruments. Windows and Internet Explorer are either registered trademarks or trademarks of Microsoft Corporation in the U.S. and/or other countries. Apple, iMac, Macintosh, Mac, Mac OS and Mac OS X are trademarks of Apple Inc., registered in the U.S. and other countries. Blu-ray is a trademark of the Blu-ray Disc Association. Crestron and RoomView are either trademarks or registered trademarks of Crestron Electronics, Inc. in the United States and/or other countries. All other third-party product and company names may be trademarks of their respective owners.

**Copyright notice**

© 2014 SMART Technologies ULC. All rights reserved. No part of this publication may be reproduced, transmitted, transcribed, stored in a retrieval system or translated into any language in any form by any means without the prior written consent of SMART Technologies ULC. Information in this manual is subject to change without notice and does not represent a commitment on the part of SMART.

This product and/or use thereof covered by one or more of the following U.S. patents.

[www.smarttech.com/patents](http://www.smarttech.com/patents)

10/2014

# Important information

Before you install and use your SMART Board interactive whiteboard system, read and understand the safety warnings and precautions in this user's guide and the included important information document. These safety warnings and precautions describe the safe and correct operation of your interactive whiteboard system and its accessories, helping you to prevent injuries and equipment damage. Ensure that your interactive whiteboard system is always being used correctly.

In this document, "interactive whiteboard system" refers to the following:

- SMART Board 480 interactive whiteboard, SMART V30 projector, accessories and optional equipment
- OR
- SMART Board M600V series interactive whiteboard, SMART V30 projector, accessories and optional equipment

The projector included with your system is designed to work only with certain SMART Board interactive whiteboard models. Contact your authorized SMART reseller ([smartechnology.com/where](http://smartechnology.com/where)) for more information.

## Safety warnings, cautions and important information

### Installation



#### **WARNING**

- Failure to follow the installation instructions shipped with your SMART product could result in personal injury and damage to the product.
- To reduce the risk of fire or electric shock, do not expose the SMART product to rain or moisture.

## IMPORTANT INFORMATION

- Two people are required to mount your SMART product because it may be too heavy for one person to safely maneuver.

When you lift your interactive whiteboard, you and your assistant should stand on either side of the screen, supporting its weight at the bottom while balancing the top with your other hands.

- When mounting the projector boom on a framed or hollow wall, attach the mounting bracket to a stud to safely support the projector's weight. If you use only drywall anchors, the drywall can fail, resulting in possible personal injury, and damage to the product which may not be covered by your warranty.
- Do not leave cables on the floor where they can be a tripping hazard. If you must run a cable over the floor, lay it in a flat, straight line and secure it to the floor with tape or a cable management strip of a contrasting color. Handle cables carefully and avoid excessive bending.

### CAUTION

- Do not operate this unit immediately after moving it from a cold location to a warm location. When the unit is exposed to such a change in temperature, moisture can condense on the lens and crucial internal parts. Allow the system to stabilize to room temperature before operation to prevent possible damage to the unit.
- Do not place the unit in hot locations, such as near heating equipment. Doing so could cause a malfunction and shorten the life of the projector.
- Avoid setting up and using the SMART product in an area with excessive levels of dust, humidity and smoke.
- Do not place your SMART product in direct sunlight or near any appliance that generates a strong magnetic field.
- If you need to lean the interactive whiteboard against a wall before you mount it, make sure it remains in an upright position, resting on the pen tray brackets, which can sustain the weight of the interactive whiteboard.

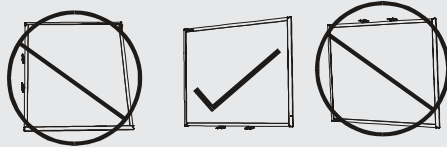

Do not rest the interactive whiteboard on its side or on the top of the frame.

## IMPORTANT INFORMATION

- You must connect the USB cable that came with your SMART Board interactive whiteboard to a computer that has a USB compliant interface and that bears the USB logo. In addition, the USB source computer must be compliant with CSA/UL/EN 60950 and bear the CE mark and CSA and/or UL Mark(s) for CSA/UL 60950. This is for operating safety and to avoid damage to the SMART Board interactive whiteboard.



### IMPORTANT

- The SMART Board M680Viv2 and 480iv2 interactive whiteboard system textless installation guide is also available online ([smarttech.com/kb/170779](http://smarttech.com/kb/170779)).
- Make sure an electrical socket is near your SMART product and remains easily accessible during use.
- Using your SMART product near a TV or radio could cause interference to the images or sound. If this happens, move the TV or radio away from the projector.

## Operation



### WARNING

- If you are using an external audio system, use only the power supply included with that product. Using the wrong power supply might create a safety hazard or damage the equipment. If in doubt, refer to the specification sheet for your product to verify the power supply type.
- Do not climb (or allow children to climb) on a wall- or stand-mounted SMART Board interactive whiteboard.
- Do not climb on, hang from or suspend objects from the projector boom.
- Climbing on the interactive whiteboard or projector boom could result in personal injury or product damage.



### CAUTION

Do not block the projector's ventilation slots and openings.



### IMPORTANT

- Keep your remote control in a safe place because there is no other way to access menu options.
- Disconnect the product from its power source when it is not used for a long period.

## Other precautions

If you own a SMART product other than a SMART Board 480iv2 interactive whiteboard system or SMART Board M680Viv2 interactive whiteboard system, refer to the installation manual for your product for relevant warnings and maintenance instructions.

## Environmental requirements

Before you install your SMART Board interactive whiteboard system, review the following environmental requirements.

Environmental requirement	Parameter
Interactive whiteboard operating temperature	<ul style="list-style-type: none"> <li>• 41°F to 95°F (5°C to 35°C) from 0' to 6000' (0 m to 1800 m)</li> <li>• 41°F to 86°F (5°C to 30°C) from 6000' to 9800' (1800 m to 3000 m)</li> </ul>
Projector operating temperature	<ul style="list-style-type: none"> <li>• 41°F to 104°F (5°C to 40°C) from 0' to 2500' (0 m to 762 m)</li> <li>• 41°F to 95°F (5°C to 35°C) from 2500' to 5000' (762 m to 1524 m)</li> <li>• 41°F to 86°F (5°C to 30°C) from 5000' to 10 000' (1524 m to 3048 m)</li> </ul>
Storage temperature	-4°F to 122°F (-20°C to 50°C)
Humidity	<ul style="list-style-type: none"> <li>• 5% to 80% operating relative humidity, non-condensing</li> <li>• 5% to 80% storage relative humidity, non-condensing</li> </ul>
Water and fluid resistance	<ul style="list-style-type: none"> <li>• Intended for indoor use only. Doesn't meet any salt-spray or water ingress requirements.</li> <li>• Don't pour or spray liquids directly onto your interactive whiteboard, the projector or any of its sub-components.</li> </ul>
Dust	<ul style="list-style-type: none"> <li>• Intended for use in office and classroom environments. Not for industrial use where heavy dust and pollutants can cause malfunctions or impaired operation. Periodic cleaning is required in areas with heavier dust. See <i>Cleaning the projector</i> on page 27 for information on cleaning the SMART V30 projector. See <i>Cleaning the air filters</i> on page 31 for information on cleaning the air filters in the SMART V30 projector.</li> </ul>
Electrostatic discharge (ESD)	<ul style="list-style-type: none"> <li>• EN61000-4-2 severity level 4 for direct and indirect ESD</li> <li>• No malfunction or damage up to 8 kV (both polarities) with a 330 ohm, 150 pF probe (air discharge)</li> <li>• Unmated connectors meet no malfunction or damage up to 4 kV (both polarities) for direct (contact) discharge</li> </ul>
Cables	All SMART Board interactive whiteboard system cables should be shielded to prevent potential accidents and degraded video and audio quality.

IMPORTANT INFORMATION

---

Environmental requirement	Parameter
Conducted and radiated emissions	EN55022/CISPR 22, Class A

---





# Contents

<b>Important information</b> .....	<b>i</b>
Safety warnings, cautions and important information .....	i
Environmental requirements .....	iv
<b>Chapter 1: About your interactive whiteboard system</b> .....	<b>1</b>
SMART V30 projector .....	2
SMART Board 480iv2 interactive whiteboard system features .....	3
SMART Board M680Viv2 interactive whiteboard system features .....	4
Included accessories .....	5
Other optional accessories .....	5
<b>Chapter 2: Installing your interactive whiteboard system</b> .....	<b>7</b>
Choosing a location .....	8
Choosing a height .....	8
Installing SMART software .....	9
Setting up the projector image .....	9
Integrating your system with peripheral devices .....	13
<b>Chapter 3: Using your interactive whiteboard system</b> .....	<b>15</b>
Using your projector .....	15
Using your interactive whiteboard .....	24
<b>Chapter 4: Maintaining your interactive whiteboard system</b> .....	<b>25</b>
Maintaining your interactive whiteboard .....	25
Cleaning the projector .....	27
Focusing and adjusting the projector image .....	27
Removing and replacing the projector lamp module .....	27
Resetting the lamp hours .....	29
Replacing the remote control battery .....	30
Cleaning the air filters .....	31
<b>Chapter 5: Troubleshooting your interactive whiteboard system</b> .....	<b>33</b>
Before you start .....	34
Resolving interactive whiteboard issues .....	35
Determining your SMART V30 projector status .....	36
Resolving projector issues .....	37
Resolving audio issues .....	42
Resolving network communication issues .....	43
Resetting your password .....	43

## CONTENTS

Transporting your interactive whiteboard system .....	44
<b>Appendix A: Remotely managing your system through a network interface .....</b>	<b>45</b>
Web page management .....	45
<b>Appendix B: Remotely managing your system through an RS-232 serial interface .....</b>	<b>51</b>
Connecting your room control system to the SMART V30 projector .....	52
Projector programming commands .....	53
<b>Appendix C: Adjusting projector settings .....</b>	<b>55</b>
<b>Appendix D: Integrating other devices .....</b>	<b>61</b>
Video format .....	61
Connecting peripheral sources and outputs .....	64
<b>Appendix E: Remote control code definitions .....</b>	<b>67</b>
<b>Appendix F: Hardware environmental compliance .....</b>	<b>69</b>
Waste Electrical and Electronic Equipment and Battery regulations (WEEE and Battery Directives) .....	69
Batteries .....	69
Mercury .....	69
More information .....	69
<b>Index .....</b>	<b>71</b>

## Chapter 1

# About your interactive whiteboard system

SMART V30 projector .....	2
SMART Board 480iv2 interactive whiteboard system features .....	3
SMART Board 480 interactive whiteboard .....	3
SMART Board M680Viv2 interactive whiteboard system features .....	4
SMART Board M600V series interactive whiteboard .....	4
Included accessories .....	5
Remote control .....	5
Pens .....	5
Other optional accessories .....	5
Hardware mounting kit .....	5

---

Your SMART Board 480iv2 interactive whiteboard system combines the following components:

- SMART Board 480 interactive whiteboard
- Wall-mounted, short-throw SMART V30 projector
- Accessories and optional equipment

Your SMART Board M680Viv2 interactive whiteboard system combines the following components:

- SMART Board M680V series interactive whiteboard
- Wall-mounted, short-throw SMART V30 projector
- Accessories and optional equipment

This chapter describes the features of your interactive whiteboard and provides information about product parts and accessories.

## SMART V30 projector

The SMART V30 projector system includes a short-throw projector for use with SMART Board interactive whiteboards and a sturdy support system ideal for classroom environments.

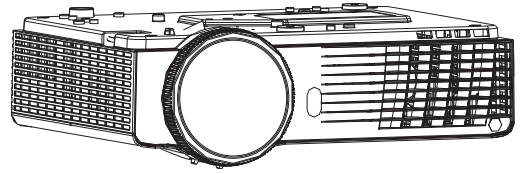

The features of the projector system include the following:

- A wall-mounted projector that uses DLP® technology by Texas Instruments™, providing BrilliantColor™ performance, High Contrast, and Gamma 2.1 correction with Bright Classroom, Dark Classroom, sRGB, User and SMART Presentation modes
  - 4:3 aspect ratio
  - 3000 ANSI lumens (typical)
  - High definition (720p and 1080p) video system compatibility and HD Ready (HDMI technology and 720p) available, NTSC, NTSC 4:43, PAL, PAL-N, PAL-M and SECAM (480i/p and 576i/p)
  - Native XGA 1024 × 768 resolution
  - Apple Macintosh, iMac and VESA® RGB video format standard compatibility
  - Remote management via network through an RJ45 cable
- OR
- Remote management via a serial RS-232 interface
  - Protected cable routing through the boom
  - Secure mounting and installation system that includes a projector padlock loop
  - An internal speaker
  - Templates and instructions for positioning the system safely

Your SMART V30 projector connection panel has the following connections:

- 3.5 mm phone jack audio input (shared by VGA 1 and VGA 2 input)
- 3.5 mm phone jack audio input (composite video)
- 3.5 mm phone jack audio variable output
- DB15F RGB VGA video input (VGA In) × 2
- DB15F RGB VGA video output (VGA Out)
- DB9F RS-232 control port

- HDMI 1.4 input
- Power (100V–240V AC at 50 Hz–60 Hz)
- Mini-USB B port (for service use only)
- RJ45 Ethernet connector
- RCA analog composite video (yellow)

## SMART Board 480iv2 interactive whiteboard system features

Your SMART Board 480iv2 interactive whiteboard system uses the XGA (4:3) short-throw SMART V30 projector. It delivers high-definition, high performance interactivity that is virtually shadow-free and glare-free.

Your interactive whiteboard system enables you to do everything you can do at your computer—open and close applications, meet with others, create new documents or edit existing ones, visit websites, play and manipulate video clips and more—just by touching the interactive surface.

The projector also supports video and audio connections from a variety of devices, including DVD and Blu-ray™ players, document cameras, and other high-definition sources, and can project media from these sources onto the interactive screen.

When you use SMART software with your SMART Board 480iv2 interactive whiteboard system, you can write over any application in digital ink using a pen or your finger, and then save these notes for future reference and distribution.

### SMART Board 480 interactive whiteboard

Your SMART Board 480 interactive whiteboard is durable and reliable. It features a rugged, hardened interactive surface, a damage-resistant pen and SMART's proprietary DVIT® (Digital Vision Touch) technology.

Other features of your interactive whiteboard include the following:

- A pen ledge that holds up to two pens
- A durable hard-coated surface that is optimized for projection and is easily cleaned

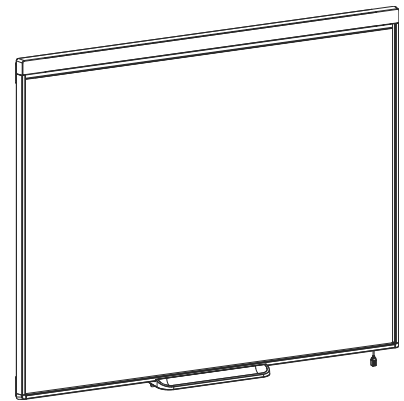

## SMART Board M680Viv2 interactive whiteboard system features

Your SMART Board M680Viv2 interactive whiteboard system uses the XGA (4:3) short-throw SMART V30 projector. It delivers high-definition, high performance interactivity that is virtually shadow-free and glare-free.

The modular and expandable hardware and software architecture of your interactive whiteboard system enables you to do everything you can do at your computer—open and close applications, meet with others, create new documents or edit existing ones, visit websites, play and manipulate video clips and more—just by touching the interactive surface.

The projector also supports video and audio connections from a variety of devices, including DVD and Blu-ray players, document cameras, and other high-definition sources, and can project media from these sources onto the interactive screen.

When you use SMART software with your SMART Board M680Viv2 interactive whiteboard system, you can write over any application in digital ink using a pen tray pen or your finger, and then save these notes for future reference and distribution.

## SMART Board M600V series interactive whiteboard

Your SMART Board M600V series interactive whiteboard, featuring SMART's proprietary DVIT technology, is the most intuitive touch-sensitive front projection interactive whiteboard in the world.

Other features of your interactive whiteboard include the following:

- A pen ledge that holds up to two pens
- A durable hard-coated surface that is optimized for projection and is easily cleaned

For more information about your SMART Board interactive whiteboard, see the *SMART Board M600 series interactive whiteboard user's guide* ([smarttech.com/kb/170410](http://smarttech.com/kb/170410)).

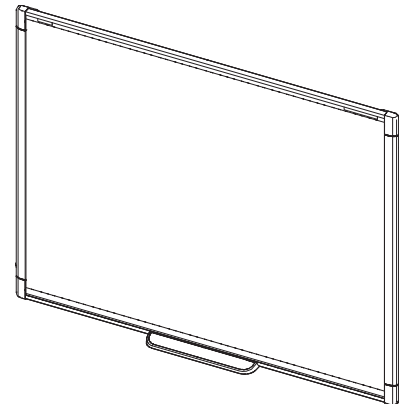

## Included accessories

The following accessories are included with your interactive whiteboard system.

### Remote control

The remote control enables you to control the system and set up your projector. Use the remote control to access menu options, system information and input selection controls.

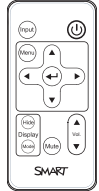

### Pens

There are two pens included with your interactive whiteboard.

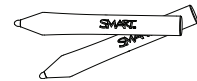

#### NOTE

Don't substitute the pens with other items, such as dry-erase markers.

## Other optional accessories

You can add a variety of accessories to your interactive whiteboard to best meet your specific needs. Purchase these items from your authorized SMART reseller ([smarttech.com/where](http://smarttech.com/where)).

For more information on accessories, go to [smarttech.com/accessories](http://smarttech.com/accessories).

### Hardware mounting kit

You can order a projector hardware mounting kit from your authorized SMART reseller ([smarttech.com/where](http://smarttech.com/where)). It contains an assortment of screws and wall anchors for several different wall types (see [smarttech.com/kb/160505](http://smarttech.com/kb/160505)).

The SB480iv2 interactive whiteboard system includes a hardware mounting kit.

You can also order a hardware mounting kit for your M680V interactive whiteboard (see [smarttech.com/kb/170475](http://smarttech.com/kb/170475)).





## Chapter 2

# Installing your interactive whiteboard system

Choosing a location .....	8
Choosing a height .....	8
Installing SMART software .....	9
Setting up the projector image .....	9
Focusing the image .....	10
Aligning the image .....	10
Projector connection diagram .....	12
Integrating your system with peripheral devices .....	13

---

Consult the SMART Board interactive whiteboard system installation document included with your product for instructions on how to install and secure your system.

See the included documents for instructions on how to cable your SMART Board interactive whiteboard system, install your product and use the mounting template.



### IMPORTANT

The *SMART Board 480iv2 and M680Viv2 interactive whiteboard system textless installation guide* is also online ([smarttech.com/kb/170779](http://smarttech.com/kb/170779)).

This chapter provides additional considerations and details for installing your interactive whiteboard system.

## Choosing a location

Choose a location for your interactive whiteboard system that's far from bright light sources, such as windows and strong overhead lighting. Bright light sources can cause distracting shadows on your interactive whiteboard and can reduce the contrast of the projected image.

Select a wall with a flat, regular surface and sufficient clearance to accommodate your interactive whiteboard system. Install the projector and your interactive whiteboard on the same flat surface. For best presentation alignment, mount your interactive whiteboard system in a location that's central to your audience's viewing direction.

For mobile or adjustable installation options, contact your authorized SMART reseller ([smarttech.com/where](https://smarttech.com/where)).



### WARNING

- When mounting the projector boom on a framed or hollow wall, attach the mounting bracket to a stud to safely support the projector's weight. If you use only drywall anchors, the drywall can fail, resulting in possible personal injury, and damage to the product which may not be covered by your warranty.
- Refer to your interactive whiteboard system's specifications (available at [smarttech.com/support](https://smarttech.com/support)) for its weight. Check your local building codes to ensure that your wall can support this weight, and use appropriate mounting hardware for your wall type.
- If you are installing the interactive whiteboard system on drywall, use all the included toggle bolts. If one of the bracket holes aligns with a wall stud, use appropriate hardware in that hole instead of a toggle bolt.

## Choosing a height

SMART includes a mounting template with each interactive whiteboard system. If you lose this template, contact your authorized SMART reseller ([smarttech.com/where](https://smarttech.com/where)). Using this template ensures that you can do the following:

- Mount the projector at a safe height for head space clearance, while maintaining enough space for airflow and installation access above the unit.
- Position the projector at the correct height above your interactive whiteboard to align the projected image with the touch screen.

Dimensions on the mounting template recommend a distance from the floor suitable for adults of average height. You should consider the general height of your user community when you choose a location for your interactive whiteboard.

## Installing SMART software

You must install SMART software, such as SMART Notebook® collaborative learning software on the computer connected to your interactive whiteboard system to access all of its features.

Download SMART software from [smarttech.com/software](http://smarttech.com/software). These web pages list the minimum hardware requirements for each software version. If SMART software is already installed on your computer, take this opportunity to upgrade your software to ensure compatibility.



### IMPORTANT

Do not connect your computer and your interactive whiteboard until you install SMART software.



### CAUTION

Install the version of SMART Product Drivers that shipped with your interactive whiteboard system, or download a newer version if available. If you use an older version of the software, your interactive whiteboard system might not function.

## Setting up the projector image

You must focus the projected image, and then align the projected image.

## Focusing the image

Use the focus lever on the bottom of the SMART V30 projector to focus the projected image.

### To focus and adjust the image

Turn the focus lever clockwise or counterclockwise until the image is in focus.

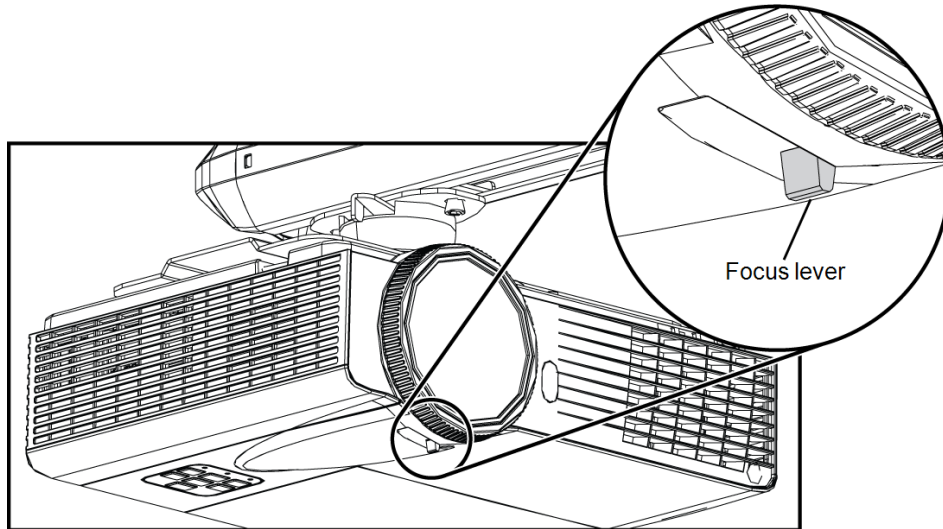

## Aligning the image

Refer to these notes when aligning the projected image as described in the included *SMART Board 480iv2 and M680Viv2 interactive whiteboard system textless installation guide* ([smarttech.com/kb/170779](http://smarttech.com/kb/170779)).

### CAUTION

Never touch the lens with your hands or a brush. This can disturb the focus or quality of image that your projector displays.

The projector's image alignment screen appears when you start your projector the first time, or you can access it from the startup screen menu any time.

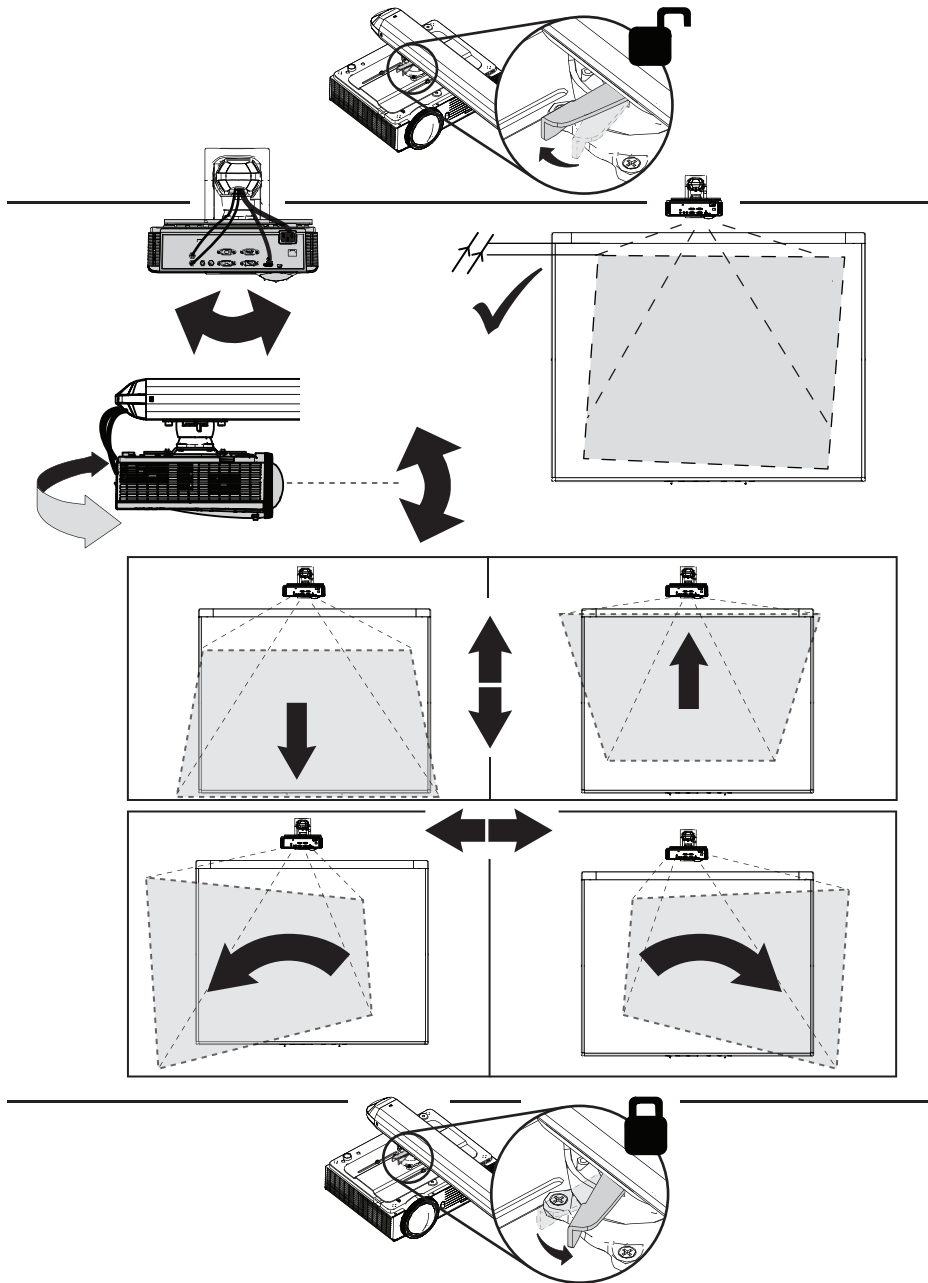

Use the mechanical adjustments described in the installation document and the image alignment screen to adjust the projected image size, shape and location so that you can see the full projected image clearly. Don't use other images, which might be cropped or scaled by the projector and result in a misleading projected image size, shape and location.

When adjusting keystone (tilt), ensure that the top and bottom edges of the image are horizontal before you position the left and right edges of the image relative to your interactive whiteboard.

To fine-tune the image, you might need to repeat all steps described in the installation document in smaller increments.

## Projector connection diagram

You can connect a variety of peripheral devices to your projector, including DVD/Blu-ray players, document cameras, and other high-definition sources, as well as peripheral device outputs such as a secondary display or powered speakers.

 **NOTE**

You might need to purchase third-party adapters to connect certain peripheral devices.

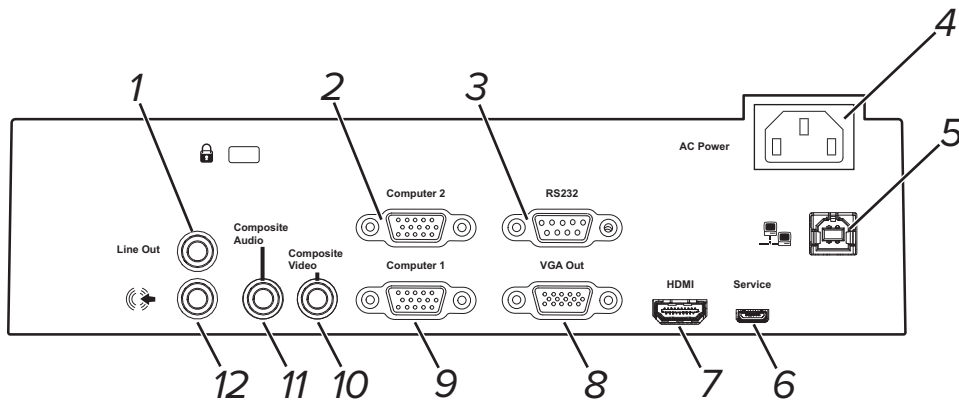

No.	Connector	Connect to:
1	3.5 mm phone jack audio variable output	External speakers (optional, not included)
2	DB15F RGB VGA video input (VGA In)	Computer standard definition media (audio and video) source (not included)
3	DB9F RS-232 control port	RS-232 control for external control systems
4	Power	Mains power supply
5	RJ45 (Cat 5)	Network (for web page management access) network connection only
6	USB B (for service access only)	Do not use (for service access only)
7	HDMI in	Computer high-definition multimedia (audio and video) source (not included)
8	DB15F RGB VGA video output (VGA Out)	Secondary display (not included)

No.	Connector	Connect to:
9	DB15F RGB VGA video input (VGA In)	Computer standard definition multimedia (audio and video) source (not included)
10	RCA analog composite video (yellow)	Composite video input that supports legacy NTSC, PAL and SECAM video standards (e.g. VCR or DVD players) (not included)
11	3.5 mm phone jack audio input (composite video)	Audio sources associated with the computer connected to the composite video input source.
12	3.5 mm phone jack audio input (shared by VGA 1 and VGA 2 input)	Audio sources associated with the computer connected to the VGA video input source.



#### NOTES

- To connect your SMART Board M680V interactive whiteboard or SMART Board 480 interactive whiteboard, see the *SMART Board 480iv2 and M680Viv2 interactive whiteboard system textless installation guide* ([smarttech.com/kb/170779](http://smarttech.com/kb/170779)).
- To connect accessories to your interactive whiteboard, refer to the documents included with the accessories and consult the SMART Support website ([smarttech.com/support](http://smarttech.com/support)) for additional information.

## Integrating your system with peripheral devices

For information on integrating your SMART Board 480iv2 or M680Viv2 interactive whiteboard system with peripheral devices, see *Connecting peripheral sources and outputs* on page 64.





## Chapter 3

# Using your interactive whiteboard system

Using your projector .....	15
Using your remote control .....	15
Using the remote control buttons .....	16
Using your projector keypad .....	17
Using your projector keypad buttons .....	17
Adjusting projector settings .....	18
Using your interactive whiteboard .....	24

---

This chapter describes the basic operation of your interactive whiteboard system and explains how to set up your remote control, retrieve system information, access the projector's image adjustment options and integrate your interactive whiteboard system with peripheral devices.

## Using your projector

This section explains how to use your projector, the included remote control and the projector's keypad.

### Using your remote control

The projector remote control enables you to access on-screen projector menus and change projector settings.

### Using the remote control buttons

The projector remote control enables you to access on-screen menus and change projector settings. Press the **Power**  button twice on the remote control to put the projector into Standby mode. You can also use the **Input** button on the remote control to switch sources on the projector.

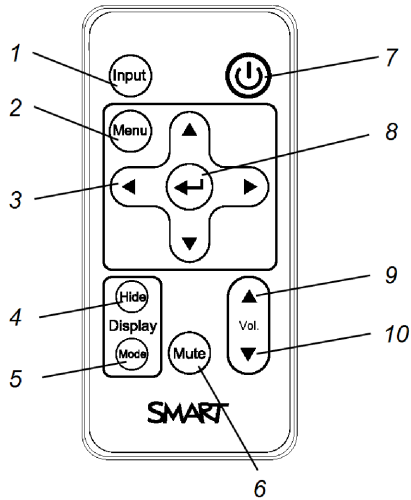

Number	Function	Description
1	Input	Select a video and audio input source on the projector.
2	Menu	Show or hide the projector menus.
3	◀ (Left), ▶ (Right), ▲ (Up) and ▼ (Down) arrows	Change the menu selections and adjustments.
4	Hide	Freeze, hide or display the image: <ul style="list-style-type: none"> <li>• Press once to freeze the image. For example, you can display a question on the screen while you check your e-mail.</li> <li>• Press again to hide the image, that is, to display a black screen.</li> <li>• Press again to return to the live image.</li> </ul>
5	Mode	Select a display mode.
6	Mute	Mute audio amplification.
7	 (Power)	Turn on the projector or put it into Standby mode.
8	↵ (Enter)	Accept the selected mode or option.
9	▲ (Volume Up)	Increase audio amplification volume.
10	▼ (Volume Down)	Decrease audio amplification volume.

 **NOTE**

The **Mute**, **Volume Up** and **Volume Down** buttons work only if there is an audio source connected to the projector for the selected video input source.

For information on using the remote control's Menu button to adjust the projector settings, see *Adjusting projector settings* on page 55.

## Using your projector keypad

The projector remote control enables you to access on-screen projector menus and change projector settings.

### Using your projector keypad buttons

The projector remote control enables you to access on-screen menus and change projector settings. Press the **Power**  button twice on the remote control to put the projector into Standby mode. You can also use the **Input** button on the remote control to switch sources on the projector.

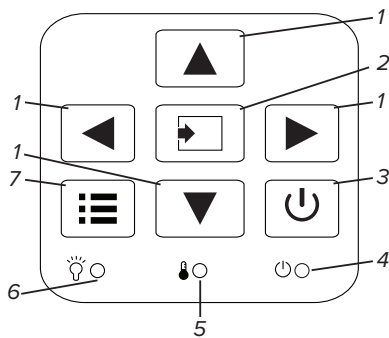

Number	Function	Description
1	◀ (Left), ▶ (Right), ▲ (Up) and ▼ (Down) arrows	Change the menu selections and adjustments.
2	Input	Select a video and audio input source on the projector.
3	 (Power)	Turn on the projector or put it into Standby mode.
4	Power indicator light	Helps indicate the status of the projector.
5	Temperature indicator light	Helps indicate the status of the projector.
6	Lamp indicator light	Helps indicate the status of the projector.
7	Menu	Show or hide the projector menus.



## Adjusting projector settings



The remote control's Menu button enables you to access the on-screen display to adjust the projector settings.





### IMPORTANT

Keep your remote control in a safe place because there is no other way to access menu options.

Setting	Use	Notes
 <b>Picture menu</b>		
Color Mode	Indicates the projector's display output ( <b>Bright Classroom, Dark Classroom, SMART Presentation, Game and User</b> ).	The default is <b>SMART Presentation</b> .
Brightness	Sets projector brightness from 0 to 100.	The default is 47.
Contrast	Sets the difference between the lightest and darkest parts of the image from 0 to 100.	The default is 55.
Sharpness	Sets the projected image's sharpness from 0 to 31.	The default is 15.
Saturation	Sets the projected image's color saturation from 0 to 100.	The default is 50.
Hue	Sets the image hue from 0 to 100.	The default is 50.
Gamma	Sets the gamma from 0 to 3.	The default is 0.
Color Temp	Sets the color temperature ( <b>Low, Mid and High</b> ).	The default is Low.
Color Space	Configures the signal color space ( <b>Auto, RGB and YUV</b> ).	The default is Auto.
 <b>Position menu</b>		
Aspect Ratio	Sets the image output to <b>Auto, 4:3, 16:9 and 16:10</b> .	The default is <b>Auto</b> .
Phase	Set lock phase which affects the horizontal position of the image.	Automatically determined by VGA source input.

Setting	Use	Notes
Clock	Set clock dot frequency. This affects the ability of the signal to lock.	Automatically determined by VGA source input.
H-Position	Set the horizontal position of the image.	Automatically determined by VGA source input.
V-Position	Set the vertical position of the image.	Automatically determined by VGA source input.
Digital Zoom	Sets the image zoom to the center of the image from 0 to 10.	The default is 0. Zooming in cuts off the outer edges of the source video.
V. Keystone	Sets the tilt of the image from -40 to 40.	The default is 0.
Ceiling Mount	Sets the projector position ( <b>Front, Front Ceiling, Rear, Rear Ceiling</b> ).	The default is Front Ceiling.
  <b>Setting menu</b>		
Language	Sets the language preference from <b>English, Spanish, Portuguese, French, Arabic, Chinese (Simplified), Chinese (Traditional), Czech, Dutch, German, Hungarian, Italian, Japanese, Korean, Norwegian, Polish, Romanian, Russian, Slovak, Swedish</b> and <b>Turkish</b> .	The default is English.
Menu Location	Sets the menu position on screen from <b>Top Left, Top Right, Center, Bottom Left</b> or <b>Bottom Right</b> .	The default is Center.
Closed caption	Turns on or turns off the closed captioning feature ( <b>Off, CC1, CC2, CC3</b> and <b>CC4</b> ).	The default is off. Closed caption applies only to Composite NTSC input sources.
VGA Out (Standby)	Turns on or turns off the VGA out terminal.	The default is off.
Test Pattern	Turns on or turns off a projected circle pattern.	

Setting	Use	Notes
Startup Logo	Turns on or turns off a startup logo when the projector lamp is starting and a video source signal isn't displayed.	The default is on.
UART Mode	Sets <b>LAN</b> terminal or the <b>RS 232</b> terminal for projector control.	The default is LAN.
LAN	Turns on or turns off the LAN terminal.	The default is off.
Reset	Resets projector settings to their default values.	If you select <b>Yes</b> , all settings return to the default values, reversing any menu changes you made. This action is irreversible. Don't adjust this setting unless you want to reset all of the applied settings, or unless you're advised to by a SMART Support specialist.
 <b>Audio menu</b>		
Mute	Mutes the projector's audio output.	The default is off. If you mute the projector's audio output and then increase or decrease the volume, the volume is restored automatically. You can prevent this from happening by disabling the volume control.
Volume	Sets the projector's volume amplification from 0 to 32.	The default is 20.
In Standby Mode	Turns on or turns off audio output when the projector is in standby mode.	The default is off.
 <b>Options menu</b>		
Auto Source	Turns on or turns off signal searching of input connectors.	The default is on. Select <b>On</b> to have the projector continuously switch inputs until it finds an active video source. Select <b>Off</b> to maintain signal detection in one input.
Input	Sets the video source ( <b>HDMI 1</b> , <b>VGA 1</b> , <b>VGA 2</b> or <b>Video 1</b> ).	The default is HDMI.

CHAPTER 3  
USING YOUR INTERACTIVE WHITEBOARD SYSTEM

Setting	Use	Notes
Auto Power Off	Sets the length of the auto power-off countdown timer between 0 to 120 minutes in five minute increments.	The default is 15 minutes. The timer begins to count down when the projector no longer receives a video signal. The timer finishes when the projector enters Standby mode. Select <b>0</b> to turn off the timer.
Lamp Settings	Displays the lamp settings on the projector.	
High Altitude	Turns on or turns off high fan speed.	The default is off.
Dust Filter Reminder	Sets the dust filter reminder settings.	

Setting	Use	Notes
Information	Provides the Model Name, Source, Resolution, Software Version, Color Space and Aspect Ratio	
<b>Lamp Settings sub-menu</b>		
Lamp Hours Used (Normal)	Displays the number of lamp hours while in Normal mode.	
Lamp Hours Used (ECO)	Displays the number of lamp hours while in Eco mode.	
Lamp Life Reminder	Turns on or turns off the lamp replacement reminder.	This reminder appears 100 hours before the recommended lamp replacement.
Lamp Power Mode	Sets the lamp power mode ( <b>Normal</b> , <b>Auto</b> , <b>ECO1</b> or <b>ECO2</b> ).	The default is Normal. <b>Normal</b> displays a high-quality, bright image. <b>ECO1</b> and <b>ECO2</b> increases the lamp life by decreasing the brightness of the image. <b>Auto</b> enables ImageCare mode which improves lamp life under most circumstances.
Clear Lamp Hours	Resets the lamp hours.	Always reset the lamp hours after you replace a lamp, because lamp service reminders are based on the current hours of use. See <i>Resetting the lamp hours</i> on page 29 for details on the lamp hours reset procedure.
<b>Filters Remind (Hour) sub-menu</b>		
Filters Remind (Hour)	Sets a reminder to clean the filter (0 to 1000 hours).	The default is 0 hours.
Cleaning Up Reminder	Turns on or turns off the filter reminder.	The default is off.
 <b>LAN Menu</b>		
DHCP	Displays the status of the network's Dynamic Host Configuration Protocol (DHCP) as <b>On</b> or <b>Off</b> .	The default is on. <b>On</b> enables a DHCP server on the network to automatically assign an IP address to the projector. <b>Off</b> enables an administrator to assign an IP address manually.



Setting	Use	Notes
IP Address	Displays the projector's current IP address in values between 0.0.0.0 and 255.255.255.255.	To assign the projector's IP address, use the projector's web page to enter an address or use a DHCP server to assign a dynamic IP address (see <i>Remotely managing your system through a network interface</i> on page 45).
Subnet Mask	Displays the projector's subnet mask number in values between 0.0.0.0 and 255.255.255.255.	
Gateway	Displays the projector's default network gateway in values between 0.0.0.0 and 255.255.255.255.	
DNS	Displays the projector's primary domain name server (DNS) IP address in values between 0.0.0.0 and 255.255.255.255.	
Store	Stores the values you entered.	
Reset	Resets values in the LAN menu to their default values.	If you select <b>Yes</b> , all LAN settings reset to their defaults, reversing any menu changes you made. This action is irreversible. Don't adjust this setting unless you want to reset all of the applied settings, or unless you're advised to by a SMART Support specialist.

## Using your interactive whiteboard

Refer to the *SMART Board 480 interactive whiteboard user's guide* ([smarttech.com/kb/156693](http://smarttech.com/kb/156693)) for more information on using your interactive whiteboard.

Refer to the *SMART Board M600 series interactive whiteboard user's guide* ([smarttech.com/kb/170410](http://smarttech.com/kb/170410)) for in-depth information on using your interactive whiteboard.

When you connect your SMART Board interactive whiteboard to a computer with SMART software, you can access the full capabilities of your interactive whiteboard.

For additional resources, go to [smarttech.com](http://smarttech.com), click the drop-down menu in the top-right corner, and then select a language. In the Support section of this website, you'll find up-to-date, product-specific information, including setup instructions and specifications.

The SMART training website ([smarttech.com/training](http://smarttech.com/training)) includes an extensive library of training resources you can refer to when first learning to set up or use your interactive whiteboard system.

## Chapter 4

# Maintaining your interactive whiteboard system

Maintaining your interactive whiteboard .....	25
Preventing damage to your interactive whiteboard .....	25
Keeping the writing surface clean .....	26
Cleaning the pen ledge .....	26
Cleaning the projector .....	27
Focusing and adjusting the projector image .....	27
Removing and replacing the projector lamp module .....	27
Resetting the lamp hours .....	29
Replacing the remote control battery .....	30
Cleaning the air filters .....	31

---

This chapter includes methods for properly cleaning and preventing damage to your SMART Board interactive whiteboard system.

## Maintaining your interactive whiteboard

For information on maintaining your interactive whiteboard, see the *SMART Board 480 interactive whiteboard user's guide* ([smarttech.com/kb/156693](http://smarttech.com/kb/156693)).

For information on maintaining your interactive whiteboard, see the *SMART Board M600 series interactive whiteboard user's guide* ([smarttech.com/kb/170410](http://smarttech.com/kb/170410)).

With proper care, your SMART Board interactive whiteboard will provide years of trouble-free service.

## Preventing damage to your interactive whiteboard

Although the surface of your interactive whiteboard is very durable, take the following precautions to prevent damage.

- Don't use sharp or pointed objects, such as ballpoint pens or pointers, as writing tools.
- Replace the pen nib when the nib wears out.

- Don't use low-odor dry-erase markers because they can be very difficult to erase. Use standard (high-odor) dry-erase markers that show a warning to use them only in well-ventilated areas.
- Don't use adhesive tape on the interactive surface.
- Don't use abrasive erasers or harsh chemicals to clean your product.
- Don't use compressed air to clean the interactive whiteboard's cameras because the force of the air could damage them.
- The digital cameras located in the corners of the frame are protected from dust and dirt by windows. In extremely dusty environments, spray a household, alcohol-free glass cleaner, such as Windex® cleaner, on a cotton swab and rub it gently on the windows. Don't use compressed air to clean the cameras.

## Keeping the writing surface clean

Follow these tips to keep the interactive whiteboard's surface clean.

- Clean your interactive whiteboard at least every six months.
- Don't spray cleaner directly onto the interactive whiteboard's surface. Instead, spray a light amount of cleaner on a cloth and then gently wipe the interactive surface.
- Don't allow excess cleaner to flow onto the frame's reflective surfaces.



### IMPORTANT

Turn off your interactive whiteboard system before you clean it so that you do not scramble the desktop icons or inadvertently activate applications when you wipe the interactive surface.



### TIP

To view dirt or streaks more easily, set your projector to Standby (lamp off) mode.

## Cleaning the pen ledge

Spray a household, alcohol-free glass cleaner, such as Windex cleaner, on a cotton swab and then carefully clean the pen ledge.

## Cleaning the projector

### WARNING

Cleaning a wall-mounted projector can result in a fall or injury. Use caution when climbing a ladder.

### CAUTION

- Before you clean the projector, press the **Power**  button twice on the remote control or the projector keypad to put the system in Standby mode, and then wait 30 minutes for the lamp to cool completely.
- Never touch the lens with your hands or a brush.
- Do not allow liquids or commercial solvents of any kind to flow into the projector base or head.

Do not spray cleaners or solvents near any part of the projector because they can spread a chemical mist on some of the projector's components and lamp, resulting in damage, staining or poor image quality.

- Do not use compressed air to clean the projector.

When cleaning the projector's lens:

- Use a bellows bulb or air blower bulb (commonly found in audio-visual supply stores) to blow off dust.
- If wiping the lens is unavoidable, wear protective gloves and gather the cleaning cloth into a ball. Gently fan the cleaning cloth across the lens like you would a feather duster. Do not apply any pressure to the lens.

## Focusing and adjusting the projector image

For information on focusing and adjusting the projector image, see *Setting up the projector image* on page 9.

## Removing and replacing the projector lamp module

Eventually the lamp module will dim, and a message will appear reminding you to replace the lamp. Make sure you have a replacement projector lamp module before proceeding.

For instructions on how to replace the projector lamp module, go to [smarttech.com/kb/170798](http://smarttech.com/kb/170798).



#### WARNING

- Replace the lamp when the projector displays its lamp life warning message. If you continue to use the projector after this message appears, the lamp can shatter or burst, scattering glass throughout the projector.
- If the lamp shatters or bursts, leave and then ventilate the area.

Next do the following:

- Avoid touching the glass fragments because they can cause injury.
- Wash your hands thoroughly if you have come into contact with lamp debris.
- Thoroughly clean the area around the projector, and discard any edible items placed in that area because they could be contaminated.
- Call your authorized SMART reseller ([smarttech.com/where](http://smarttech.com/where)) for instructions. Do not attempt to replace the lamp.
- When replacing the projector lamp:
  - Put the projector into Standby mode and wait 30 minutes for the lamp to cool completely.
  - Do not remove any screws other than those specified in the lamp replacement instructions.
  - Wear protective eyewear while changing the lamp. Failure to do so can cause injuries including loss of eyesight if the lamp shatters or bursts.
  - Use only replacement lamps approved by SMART Technologies. Contact your authorized SMART reseller ([smarttech.com/where](http://smarttech.com/where)) for replacement parts.
  - Never replace the lamp module with a previously used lamp module.
  - Always handle the fragile lamp module with care to prevent premature lamp failure or exposure to mercury. Use gloves when touching the lamp. Do not touch the lamp with your fingers.
  - Recycle or dispose of the lamp module as hazardous waste in accordance with local regulations.
- See [smarttech.com/compliance](http://smarttech.com/compliance) for the projector's Material Safety Data Sheets (MSDS) documents.

## Resetting the lamp hours

After you replace the lamp module, you need to access the projector service menu to reset the lamp hours. To prevent accidental errors, only a system administrator should perform this procedure.

### NOTE

Always reset the lamp hours after you replace the lamp, because lamp service reminders are based on the current hours of use.

### To reset the lamp hours

### CAUTION

Do not reset the lamp hours unless you have just replaced the lamp module. Resetting the lamp hours on an old lamp can damage your projector as a result of lamp failure.

1. Using the remote control, press the **Menu** button.
2. Scroll to *Options*, and then press **Enter**.
3. Scroll to *Lamp Settings*, and then press **Enter**.
4. Scroll to *Clear Lamp Hours*, and then press **Enter**.

The lamp hours values reset to zero.

5. Press the **Menu** button to return to *Lamp Settings*.

Confirm *Lamp Hours Used (Normal)* and *Lamp Hours Used (ECO)* are reset to zero.

## Replacing the remote control battery

Follow this procedure to replace the remote control battery.

### WARNING

- Reduce the risk associated with a leaking battery in the projector's remote control by following these practices:
  - Use only the specified CR2025 coin-cell battery.
  - Remove the battery when the remote control is unused for an extended period.
  - Do not heat, disassemble, short or recharge the battery, or expose it to fire or high temperatures.
  - Avoid eye and skin contact with the battery if it has a leak.
- Dispose of the exhausted battery and product components in accordance with applicable regulations.

### To replace the remote control battery

1. Hold down the side release on the left side of the battery holder and pull the battery holder completely out of the remote control.

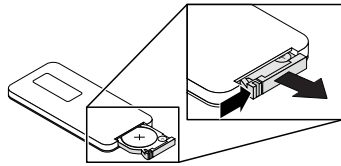

2. Remove the old battery from the battery holder and replace it with a CR2025 coin-cell battery.

### IMPORTANT

Align the battery's positive (+) and negative (-) terminals with the correct signs on the battery holder.

3. Insert the battery holder into the remote control.



## Cleaning the air filters

### WARNING

Cleaning a wall-mounted projector can result in a fall or injury. Use caution when climbing a ladder.

### CAUTION

- Before you clean the projector, press the **Power**  button twice on the remote control or the projector keypad to put the system in Standby mode, and then wait 90 seconds for the fans to turn off.
- When you clean the air filters, SMART recommends you wear protective gloves and, a face mask or a respirator.
- Clean the air filters in a well-ventilated area.

A message will appear reminding you to clean the filters.

When cleaning the air filters:

- Use compressed air to clean the filters.
- You can also order replacement air filters (part no. 1026200) from your authorized SMART reseller ([smarttech.com/where](http://smarttech.com/where)). It contains two replacement air filters.

### To clean the air filters

1. Press the **Power**  button twice on the remote control or the projector keypad to put the system in Standby mode, and then wait 90 seconds for the fans to turn off.

CHAPTER 4  
MAINTAINING YOUR INTERACTIVE WHITEBOARD SYSTEM

2. Locate the two filters on each side on the rear of the projector.

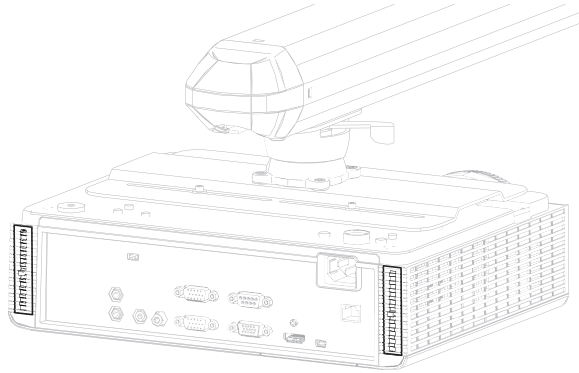

3. Remove the filters from the projector.

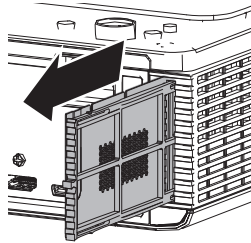

4. Clean the filter with compressed air.
5. Insert the clean filter.

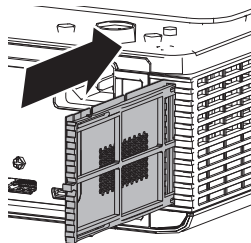

## Chapter 5

# Troubleshooting your interactive whiteboard system

Before you start .....	34
Locating status lights .....	34
Locating serial numbers .....	34
Resolving interactive whiteboard issues .....	35
Adjusting the projected image .....	35
Resetting your interactive whiteboard .....	36
Resolving connection issues .....	36
Determining your SMART V30 projector status .....	36
Resolving projector issues .....	37
Resolving projector errors .....	37
Your projector stops responding .....	37
The “Projector Overheated”, “Fan Failure”, “Lamp Failure” or “Color Wheel Failure” message appears .....	37
The “Lamp Failure” message appears .....	38
The projector Power light is off .....	38
Resolving image issues .....	39
Loss of signal .....	39
Partial, scrolling or incorrectly displayed image .....	39
Unstable or flickering image .....	40
Frozen image .....	41
The image from your connected laptop computer isn’t projected .....	41
Unaligned projected image .....	41
Resolving audio issues .....	42
Resolving network communication issues .....	43
Resetting your password .....	43
Resetting the projector .....	44
Transporting your interactive whiteboard system .....	44

---

This chapter provides basic troubleshooting information for your interactive whiteboard system.

For issues not covered in this chapter, consult the SMART Support website ([smarttech.com/support](http://smarttech.com/support)) or contact your authorized SMART reseller ([smarttech.com/where](http://smarttech.com/where)).



## Before you start

Before you troubleshoot your interactive whiteboard system or contact SMART Support or your authorized SMART reseller ([smarttech.com/where](http://smarttech.com/where)) for assistance, you need to do the following:

- Locate your interactive whiteboard system's status lights
- Locate your interactive whiteboard system's serial numbers

### Locating status lights

Your interactive whiteboard system consists of several components, which have their own status lights:

- The SMART Board 480 and SMART Board M680V interactive whiteboard don't have status lights. SMART Product Drivers must be installed to view the interactive whiteboard's status.
- Your projector's Power , Temperature  and Lamp  indicator lights are located on the bottom of the projector.

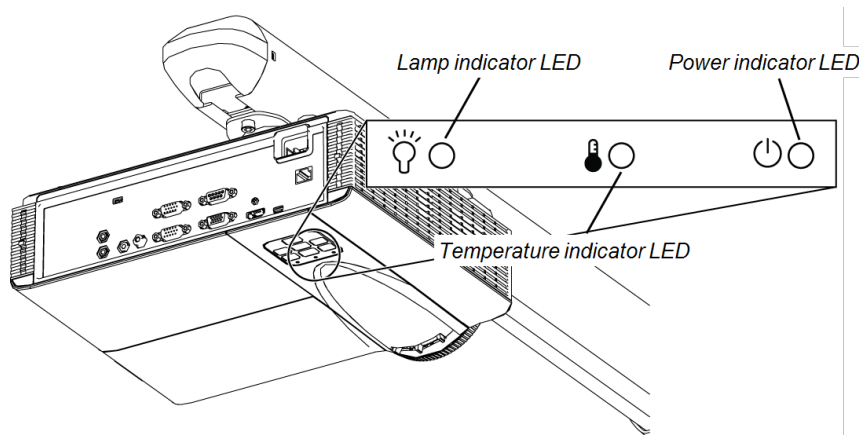

### Locating serial numbers

The SMART Board 480 interactive whiteboard serial number is located on the lower-right edge of your interactive whiteboard's frame. For more information, see the *SMART Board 480 interactive whiteboard user's guide* ([smarttech.com/kb/156693](http://smarttech.com/kb/156693)).

The SMART Board M600 series interactive whiteboard serial number is located on the lower-right edge of the frame, as well as on the back of the interactive whiteboard. For more information, see the *SMART Board M600 series interactive whiteboard user's guide* ([smarttech.com/kb/170410](http://smarttech.com/kb/170410)).

The SMART V30 projector serial number is located on the bottom of the projector.

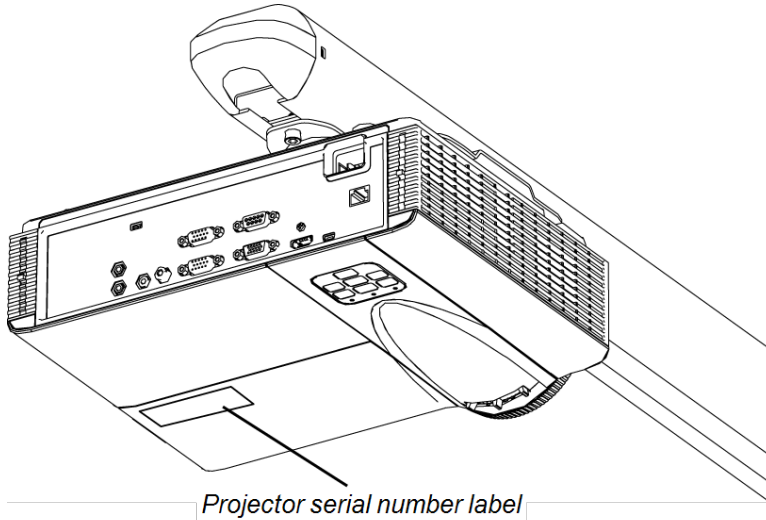

 **TIP**

You can also access the projector's serial number through the on-screen menu. For more information, see *Adjusting projector settings* on page 55.

For the locations of serial numbers on other components and accessories, see [smarttech.com/support](http://smarttech.com/support).

## Resolving interactive whiteboard issues

This section includes information on resolving issues with your interactive whiteboard.

For information not covered in this section, see the *SMART Board 480 interactive whiteboard user's guide* ([smarttech.com/kb/156693](http://smarttech.com/kb/156693)) or the *SMART Board M600 series interactive whiteboard user's guide* ([smarttech.com/kb/170410](http://smarttech.com/kb/170410)).

### Adjusting the projected image

- If your projector isn't installed in a fixed location, you can correct many image problems by shifting your projector so that the projected image fits squarely on the interactive surface. Optimally, each side of the image should extend almost to the edge of the interactive surface.

- If necessary, complete additional troubleshooting with the guidance of SMART Support using SMART Board Diagnostics.
- For more projector troubleshooting tips, see *Resolving projector issues* on the next page.

## Resetting your interactive whiteboard

You can reset your interactive whiteboard by disconnecting and then reconnecting the power cable. This turns the power off and back on, restarting all components of your interactive whiteboard.



## Resolving connection issues

- Confirm that the projector’s on-screen menu option for the USB receptacle is set to the correct video source.
- Confirm that the USB cable is properly connected from a fully functional USB receptacle on the computer to the interactive whiteboard.

## Determining your SMART V30 projector status

Your projector’s Power , Temperature  and Lamp  indicator lights are located on the bottom of the projector.

Use the following table to determine the status of your interactive whiteboard system:

Power indicator light 	Temperature indicator light 	Lamp indicator light 	Projector status
Solid red	Off	Off	Standby
Flashing green	Off	Off	Powering up
Solid green	Off	Off	On
Flashing red	Off	Off	Cooling
Alternating green and red	Solid red	Solid red	Downloading firmware
Solid red	Solid red	Off	Projector over-heated
Solid red	Flashing red	Off	Fan breakdown
Solid red	Off	Solid red	Lamp failure
Solid red	Off	Flashing red	Color wheel breakdown

# Resolving projector issues

## Resolving projector errors

System administrators can resolve the following projector errors on their own prior to contacting SMART Support. Performing initial troubleshooting on your projector reduces the time of a support call.

### Your projector stops responding

If your projector stops responding, perform the following procedure.

#### To restart an unresponsive projector

1. Put the projector into Standby mode, and then wait 30 minutes for it to cool down.
2. Disconnect the power cable from the power outlet, and then wait at least 60 seconds.
3. Connect the power cable, and then turn on the projector.

### The “Projector Overheated”, “Fan Failure”, “Lamp Failure” or “Color Wheel Failure” message appears

If the “Projector Overheated”, “Fan Failure” or “Color Wheel Failure” message appears and the projector stops projecting an image, one of the following issues is occurring:

- The projector is overheating internally because of blocked air vents or an internal temperature over 55°C (131°F).
- The temperature is overheating but the “Projector Overheated” message fails to display.
- The temperature outside the projector is too high.
- One of the fans has failed.
- The projector has a color wheel issue.

#### To resolve the “Projector Overheated”, “Fan Failure” or “Color Wheel Failure” error

1. Put the projector into Standby mode, and then wait 30 minutes for it to cool down.
2. If your room is hot, lower the temperature if possible.
3. Ensure that nothing is blocking the projector’s air intake and exhaust.
4. Disconnect the power cable from the power outlet, and then wait at least 60 seconds.
5. Connect the power cable, and then turn on the projector.
6. Adjust the fan speed using the service menu.

7. If the previous steps don't resolve the issue, put the projector into Standby mode, disconnect the power cable, and then contact your authorized SMART reseller ([smarttech.com/where](http://smarttech.com/where)).

### The “Lamp Failure” message appears

If the “Lamp Failure” message appears, one of the following issues is occurring:

- The lamp is overheating, likely due to blocked air vents.
- The lamp has reached the end of its life.
- The projector has an internal problem.

### To resolve the “Lamp Failure” error

1. Restart the projector (see *Resolving projector errors* on the previous page).
2. Check the remaining lamp hours using the on-screen menu (see *Adjusting projector settings* on page 55).

If the lamp has close to 6500 hours of use in Standard mode or close to 8000 hours of use in Economy mode, it's near the end of its lifespan.

3. Replace your lamp as described in *Removing and replacing the projector lamp module* on page 27.
4. If replacing the lamp module doesn't resolve the issue, put the projector into Standby mode, disconnect the power cable, and then contact your authorized SMART reseller.

### The projector Power light is off

If the projector Power light is off, one of the following issues is occurring:

- There was a power outage or a power surge.
- A circuit breaker or a safety switch was tripped.
- The projector isn't connected to the power source.
- The projector has an internal problem.

### To resolve the unlit projector Power light issue

1. Check the power source, and then make sure that all cables are connected.
2. Confirm that the projector is connected to an active power outlet.
3. Make sure the pins on the connectors aren't broken or bent.
4. Connect the power cable, and then turn on the projector.
5. If the previous steps don't resolve the issue, disconnect the power cable and then contact your authorized SMART reseller.



## Resolving image issues

To resolve common image issues, complete the following tasks:

- Ensure the computer or other video source is on and set to display a resolution and refresh rate supported by the projector (see *Video format* on page 61).
- Ensure the video source is properly connected to the projector.
- Press the Input Select button on the remote control or the projector keypad to switch to the correct video source.

If these tasks don't resolve the issue, refer to the following sections for additional troubleshooting information.

### Loss of signal

If a video source signal isn't detected, if it's out of range of the projector's support video modes or if the signal is being switched to a different device or input, the projector doesn't show a source signal and instead displays the SMART logo on a blue screen.



### To resolve signal loss issues

1. Wait approximately 45 seconds for the image to synchronize. Some video signals require a longer synchronization period. Cycling back through inputs to the one you want also helps image synchronization.
2. If the image doesn't synchronize, check your cable connections to the projector.
3. Ensure that the image signal is compatible with the projector (see *Video format* on page 61).
4. If there are any extension cables, switch boxes, connection wall plates or other devices in the video connection from the computer to the projector, temporarily remove them to ensure they aren't causing the video signal loss.
5. If your projector still doesn't show a source signal, contact your authorized SMART reseller ([smarttech.com/where](http://smarttech.com/where)).

### Partial, scrolling or incorrectly displayed image

#### NOTE

This procedure may vary depending on your version of Windows® operating system or Mac OS X operating system software and your system preferences. The following procedures apply to Windows 7 operating systems and Mac OS X 10.8 operating system software.

**To resolve a partial, scrolling or incorrectly displayed image on your Windows computer**

1. Select **Start > Control Panel**.
2. Click **Display**, and then select **Adjust resolution**.
3. Verify that your display resolution setting is XGA 1024 × 768.
4. Click **Advanced settings**, and then click the **Monitor** tab.
5. Verify that the screen refresh rate is 60 Hz.

**To resolve a partial, scrolling or incorrectly displayed image on your Mac computer**

1. Select **Apple Menu > System Preferences**.  
The *System Preferences* dialog box appears.
2. Click **Displays**.
3. Verify that your display resolution setting is XGA 1024 × 768.
4. Verify that the screen refresh rate is 60 Hz.

**Unstable or flickering image**

If the projector's image is unstable or flickering, the frequency or tracking settings on your input source could be different from the settings on your projector.



**IMPORTANT**

Write down your setting values before adjusting any of the settings in the following procedure.

**To resolve your unstable or flickering image**

1. Check the display mode of your computer's graphics card. Make sure it matches one of the projector's compatible signal formats (see *Video format* on page 61). Refer to your computer's manual for more information.
2. Configure the display mode of your computer's graphics card to make it compatible with the projector. Refer to your computer's manual for more information.

### Frozen image

If your projector has a frozen image, perform the following procedure.

#### To resolve a frozen image

1. Ensure that the Hide Display feature is off.
2. Press the **Hide** button on the projector's remote control to hide or show the display.
3. Ensure that your source device, such as your DVD player or computer, isn't malfunctioning.
4. Put the projector into Standby mode, and then wait 30 minutes for it to cool down.
5. Disconnect the power cable from the power outlet, and then wait at least 60 seconds.
6. Connect the power cable, and then turn on the projector.
7. If the previous steps don't resolve the issue, contact your authorized SMART reseller ([smarttech.com/where](http://smarttech.com/where)).

### The image from your connected laptop computer isn't projected

Laptop computer settings can interfere with projector operations.

Some laptop computers deactivate their screens when you connect a secondary display. Refer to your computer's manual for details on reactivating the computer's display screen.

### Unaligned projected image

Alignment errors occur when the projected image isn't perpendicular to the screen. Alignment errors can occur when you mount your interactive whiteboard system on an uneven surface or a wall that has obstructions, or if you swivel the projector too far from the vertical center of your interactive whiteboard.

Use the instructions in the included *SMART Board 480iv2 and M680Viv2 interactive whiteboard system textless installation guide* is also online ([smarttech.com/kb/170779](http://smarttech.com/kb/170779)) to eliminate most image alignment issues.

The projector image can slip if the projector is moved often or installed in a location prone to vibration, such as next to a heavy door. Follow these precautions to help prevent the image from becoming unaligned:

- Make sure that the installation wall is plumb and square and doesn't move or vibrate excessively.
- Make sure that there are no obstructions behind the projector's wall-mounting bracket, and that the bracket is firmly secured to the wall according to the installation instructions.

- Make sure that the two screws on the top of the projector's gimbal are tight.
- Make sure that the two screws for the projector boom are tight.

## Resolving audio issues

The projector does have an integrated speaker, you can connect an external audio system to the audio output connector in the projector's connection panel such as the SMART SBA-L projection audio system ([smarttech.com/kb/142552](http://smarttech.com/kb/142552))

If no sound is coming from your external audio system, perform the following procedure.

### NOTE

You might need to configure your computer to pass audio through HDMI if it isn't configured automatically.

To resolve audio issues, complete the following tasks:

- If you are using optional external speakers or an external audio system, ensure that the speakers' or audio system's cables are properly connected to the audio output plug on the projector's connection panel.
- Ensure that the video cable from your computer is connected to the appropriate video connector on your projector.
- If you're using a VGA cable, ensure that the analog audio cable from your computer's audio output is connected to the projector's VGA audio input connector.
- Press the **Mute** button on the projector's remote control, and if Audio Mute is on, turn it off.
- Use the projector's remote control to ensure that the volume isn't at the lowest setting.
- If you're using an external audio system, ensure that your speaker or audio system is on and that the volume is turned up.
- Check that your video source input, such as your computer or video device, isn't malfunctioning. Ensure that its audio output is on and that the volume isn't set to the lowest position.

### NOTE

You must display the source input's video to play its audio through the connected speakers or audio system.

- Ensure that the correct audio output device is selected in your computer's Sound settings.

- If your computer's video signal is connected with an HDMI cable, ensure that your computer's audio output is also configured to output audio via the same HDMI cable. If your computer's video signal is connected with a VGA cable, ensure that your computer's audio output is configured to use its analog audio cable connected between the computer and the projector.



#### NOTE

If you're using an HDMI video input on the projector, don't use any DVI to HDMI adapters, as these won't transfer audio from the DVI source to the HDMI input on the projector.

- If the previous steps don't resolve the issue, contact your authorized SMART reseller ([smarttech.com/where](http://smarttech.com/where)).

## Resolving network communication issues

If you don't have network access, perform the following procedure to troubleshoot your system.

### To resolve network communication issues

1. Ensure that your network cable is properly connected to the RJ45 connection on the projector's connection panel.
2. To activate the projector's network features, use the "network=on" RS-232 command (see *Projector programming commands* on page 53) or enable the **LAN** setting (see *Adjusting projector settings* on page 55). The network features on the projector don't work until you complete one of these tasks.
3. Press the **Menu** button, and then select the **Network Settings** menu to check the IP address. See *Adjusting projector settings* on page 55 for a description of the IP address field. Enter this IP address into your browser or SNMP agent.
4. If you still don't have network access, contact your network administrator. If your administrator is unable to resolve the issue, contact your authorized SMART reseller ([smarttech.com/where](http://smarttech.com/where)).

## Resetting your password

If you forget the projector's password, you can reset it by performing a factory reset. See *Resetting the projector* on the next page.

## Resetting the projector

At some point during troubleshooting, you might need to reset all projector settings.



### IMPORTANT

This action is irreversible.

#### To reset all projector settings

1. Using the remote control, press the **Menu** button.
2. Scroll to *Setting*, and then press **Enter** on the remote control.
3. Scroll to *Reset*, and then press **Enter**.

A confirmation dialog box appears.

4. Scroll to *Yes* and press **Enter**.
5. The projector settings reset.

## Transporting your interactive whiteboard system

Save your original interactive whiteboard system packaging so that it's available if you need to transport your interactive whiteboard system. When required, repack it with all of the original packaging. This packaging was designed to provide optimal shock and vibration protection. If you no longer have your original packaging, purchase the same packaging directly from your authorized SMART reseller ([smarttech.com/where](http://smarttech.com/where)).

If you prefer to use your own packaging materials, make sure you adequately protect your unit. Make sure that the projector lens is protected against any physical contact or pressure which may damage the projector's optics. Ship your interactive whiteboard in an upright position to deter shippers from placing heavy objects on it.

## Appendix A

# Remotely managing your system through a network interface

Web page management .....	45
Accessing web page management .....	45
Home .....	46
LAN Setting .....	47
Projector Status and Control .....	48
E-mail Setting .....	49
Security Setting .....	49

This chapter includes detailed instructions on how to remotely manage your SMART Board interactive whiteboard system settings through a network interface.

## Web page management

You can access advanced setup features via the projector's web page. This web page enables you to manage the projector from a remote location using any computer connected to your intranet.

### NOTE

To access the web page, your browser must support JavaScript. Most commonly used browsers like Internet Explorer®, Chrome™ and Firefox® support JavaScript.

## Accessing web page management

Before you can access the web page, connect your projector to the network, and then enable the projector's network functions using the projector's menu. An IP address appears on the on-screen display.

### NOTE

You can view the projector's IP address by accessing the projector's LAN Settings menu page (see *Adjusting projector settings* on page 55).

## To use the management web page

1. Start your Internet browser.
2. Type the IP address in the address box, and then press **Enter**.  
The *SMART V30 Projector Settings* window appears.
3. Select the menu options in the left pane to access the settings on each page.
4. Modify settings using your computer's mouse and keyboard, and then click **Submit** or another action button next to each setting you change.

## Home

The Home menu page displays basic projector information and enables you to select the on-screen display language.

### NOTE

You can view basic projector information but you're unable to change it (with the exception of the on-screen display language) from the Projector Information menu page.

Submenu setting	Description
Model Name	Displays the model name.
Projector Name	Displays the projector name. Set in <i>LAN Setting</i> on the next page.
Location	Displays the projector's location. Set it in <i>LAN Setting</i> on the next page.
Contact	Displays contact information. Set it in <i>LAN Setting</i> on the next page.
Status	Displays the projector's status.
Lamp Hours	Displays how many hours the lamp has been on
Operation hours	Displays how many hours the projector has been on
IP Address	Displays the IP address. Can be set it in <i>LAN Setting</i> on page 1.
MAC Address	Displays the MAC Address.
Admin Password	Displays the administrator password. Set it in <i>Security Setting</i> on page 49.
Language	Sets the language from English, German, Spanish, French, Italian, Dutch, Portuguese, Japanese, Simplified
Projector Information	Displays current projector information



## LAN Setting

This menu allows you to use or not use Dynamic Host Control Protocol (DHCP) and to set the network-related addresses and names when DHCP isn't used. You can also change the projector name, location and contact information.

Submenu setting	Description
Model name	Displays the projector's model.
Projector name	Type a name for the projector. Click <b>Save</b> .
Location	Type a location for the projector. Click <b>Save</b> .
Contact	Type contact information. Click <b>Save</b> .
DHCP	Determines if the projector's IP address and other network settings are dynamically assigned by a DHCP server or are manually set. <ul style="list-style-type: none"><li>• <b>DHCP</b> allows the network's DHCP server to assign a dynamic IP address to the projector.</li><li>• <b>Manual</b> allows you to manually set the projector's IP address and other network settings.</li></ul>
IP Address	Displays or allows you to set the projector's IP address in values between 0.0.0.0 and 255.255.255.255.
Subnet Mask	Displays or allows you to set the projector's subnet mask number in values between 0.0.0.0 and 255.255.255.255.
Gateway	Displays or allows you to set the projector's default network gateway in values between 0.0.0.0 and 255.255.255.255.
DNS	Displays or allows you to set the projector's IP address for your network's primary domain name server in values between 0.0.0.0 and 255.255.255.255.
<b>Crestron® Control System Device</b>	
IP Address	Type the IP address for the Crestron RoomView® Express management software.
Device ID	Type the Device ID for the Crestron RoomView Express management software.
Port	Configure the Port for the Crestron RoomView Express management software.

## Projector Status and Control

This menu allows you to set projector status, image options and audio options.

Submenu setting	Description
<b>Projector Status</b>	
<ul style="list-style-type: none"><li>• Click <b>Refresh</b> to update the projector status.</li><li>• Click <b>Power ON</b> to turn on the projector.</li><li>• Click <b>Power OFF</b> to turn off the projector.</li><li>• Click <b>Set</b> to save changes to Projector Status options.</li><li>• Click <b>Clear</b> to reset Projector Status options.</li></ul>	
Projector Status	Displays the projector's status.
Auto Power Off (Min)	Sets the length of the auto power-off countdown timer between 0 to 120 minutes in five minute increments.
Alert Status	Displays the projector's error status.
<b>Image Control</b>	
Ceiling Mount	Sets the projector position ( <b>Front, Front Ceiling, Rear, Rear Ceiling</b> ).
Input	Sets the video input source ( <b>HDMI, Computer 1, Computer 2, Video</b> ).
Color Mode	Sets the projector's display output ( <b>Dynamic, PC, Movie, Gamer, User</b> ).
AV Mute	Turns on or turns off the video source's audio output.
Aspect Ratio	Sets the image output to <b>Auto, 4:3, 16:9</b> and <b>16:10</b> .
Brightness	Sets projector brightness from 0 to 100. Click <b>Set</b> to save the new brightness setting.
Contrast	Sets the difference between the lightest and darkest parts of the image from 0 to 100.
<b>Audio Control</b>	
Volume	Sets the audio output from 0 to 32.
Mute	Turns on or turns off the projector's audio output.

## E-mail Setting

This menu allows you to send an email if an error occurs with the projector's lamp, the lamp life and projector's temperature.

Submenu setting	Description
<b>Email Alert</b>	
<ul style="list-style-type: none"><li>Click E-mail Alert Test once you've entered an email address in the <i>TO</i> field.</li></ul>	
E-mail Alert	Turn on or turn off the email alert.
TO	Type a valid recipient email address .
CC	Type a valid cc recipient address.
From	Type a valid recipient address for the sender.
Subject	Type a subject line for the email alert.
<b>SMTP Setting</b>	
Outgoing SMTP server	Type the SMTP server address.
<b>Alert Condition</b>	
Lamp warning	When selected, you receive an email if there's an issue with the lamp.
Lamp life reminder	When selected, you receive an email reminding you about the remaining lamp life.
Temperature warning	When selected, you receive an email if there's an issue with the projector's temperature.

## Security Setting

This menu allows you to enable and set a password.

Submenu setting	Description
Password	Enable or disable the password. Click <b>Submit</b> .
New password	Type the new password.
Confirm password	Type the new password again. Click <b>Submit</b> .



## Appendix B

# Remotely managing your system through an RS-232 serial interface

Connecting your room control system to the SMART V30 projector .....	52
Pin configuration on the projector's RS-232 connector .....	52
Serial interface settings .....	52
Projector programming commands .....	53

---

This appendix includes detailed instructions on how to set up your computer or room control system to remotely manage your SMART Board interactive whiteboard system settings through an RS-232 serial interface.

# Connecting your room control system to the SMART V30 projector

By connecting a computer or room control system to the RS-232 serial interface of the SMART V30 projector, you can select video inputs, start up or shut down your interactive whiteboard system and request information such as projector lamp use, current settings and network addresses.

## Pin configuration on the projector's RS-232 connector

The following table provides the pin configuration on the SMART V30 projector. This pin configuration follows a three-wire connection so that a straight-through male-to-female RS-232 serial cable connects to the projector's serial interface in the following arrangement:

Pin number	Projector's female RS-232 connector
2	Transmit data (Tx)
3	Receive data (Rx)
5	Signal Ground (GND)

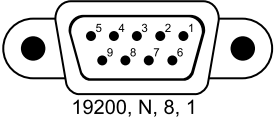

## Serial interface settings

To be able to make use of the projector's control port, your computer equipment or room control system must be configured to match these serial data communications settings.

Setting	Value
Data Rate	19.2 kbps
Data Bits	8
Parity	None
Stop Bits	1
Flow Control	None

### NOTES

- Asynchronous mode is disabled by default in the projector.
- All commands should be in ASCII format. Terminate all commands with a carriage return.
- All responses from the projector are terminated with a command prompt. Wait until you receive the command prompt indicating that the system is ready for another command

before you continue.

- The room control feature of the projector is always on.

### To configure your computer's serial interface

1. Turn on your computer, and then start your serial communications program or terminal emulation program.
2. Connect your computer to the serial connection cable connected to the projector.
3. Configure your serial interface settings using the values in the previous table, and then press **Enter**.

The > character appears as a command prompt.



#### NOTE

If no message appears or an error message appears, your serial interface configuration isn't correct. Repeat step 3.

4. Type commands to configure your settings.



#### NOTES

- To see a list of commands available in the current operating mode, type ? and then press **Enter**.
- If you're using a terminal emulation program, turn on your program's local echo setting to see characters as you type them.

## Projector programming commands

This section documents the projector programming commands and responses. You are unable to enter programming commands when the projector is powering on or cooling.

Usable command by power state		Property	Valid values
Standby / idle	On		
on	on		powerstate=powering
off	off		powerstate=cooling

APPENDIX B  
**REMOTELY MANAGING YOUR SYSTEM THROUGH AN RS-232 SERIAL INTERFACE**

Usable command by power state		Property	Valid values
Standby / idle	On		
get	get	powerstate	<ul style="list-style-type: none"> <li>• powering</li> <li>• cooling</li> <li>• on</li> <li>• standby</li> </ul>
set	set	input=<target>	<ul style="list-style-type: none"> <li>• HDMI1</li> <li>• VGA1</li> <li>• VGA2</li> <li>• Composite 1</li> </ul>
set	set	vol+<value>	1-32
set	set	vol-<value>	1-32
set	set	volume	1-32



## Appendix C

# Adjusting projector settings

The remote control's Menu button enables you to access the on-screen display to adjust the projector settings.





### IMPORTANT



Keep your remote control in a safe place because there is no other way to access menu options.

Setting	Use	Notes
 <b>Picture menu</b>		
Color Mode	Indicates the projector's display output ( <b>Bright Classroom, Dark Classroom, SMART Presentation, Game</b> and <b>User</b> ).	The default is <b>SMART Presentation</b> .
Brightness	Sets projector brightness from 0 to 100.	The default is 47.
Contrast	Sets the difference between the lightest and darkest parts of the image from 0 to 100.	The default is 55.
Sharpness	Sets the projected image's sharpness from 0 to 31.	The default is 15.
Saturation	Sets the projected image's color saturation from 0 to 100.	The default is 50.
Hue	Sets the image hue from 0 to 100.	The default is 50.
Gamma	Sets the gamma from 0 to 3.	The default is 0.
Color Temp	Sets the color temperature ( <b>Low, Mid</b> and <b>High</b> ).	The default is Low.
Color Space	Configures the signal color space ( <b>Auto, RGB</b> and <b>YUV</b> ).	The default is Auto.

APPENDIX C  
ADJUSTING PROJECTOR SETTINGS

Setting	Use	Notes
 <b>Position menu</b>		
Aspect Ratio	Sets the image output to <b>Auto</b> , <b>4:3</b> , <b>16:9</b> and <b>16:10</b> .	The default is <b>Auto</b> .
Phase	Set lock phase which affects the horizontal position of the image.	Automatically determined by VGA source input.
Clock	Set clock dot frequency. This affects the ability of the signal to lock.	Automatically determined by VGA source input.
H-Position	Set the horizontal position of the image.	Automatically determined by VGA source input.
V-Position	Set the vertical position of the image.	Automatically determined by VGA source input.
Digital Zoom	Sets the image zoom to the center of the image from 0 to 10.	The default is 0. Zooming in cuts off the outer edges of the source video.
V. Keystone	Sets the tilt of the image from -40 to 40.	The default is 0.
Ceiling Mount	Sets the projector position ( <b>Front</b> , <b>Front Ceiling</b> , <b>Rear</b> , <b>Rear Ceiling</b> ).	The default is Front Ceiling.
 <b>Setting menu</b>		
Language	Sets the language preference from <b>English</b> , <b>Spanish</b> , <b>Portuguese</b> , <b>French</b> , <b>Arabic</b> , <b>Chinese (Simplified)</b> , <b>Chinese (Traditional)</b> , <b>Czech</b> , <b>Dutch</b> , <b>German</b> , <b>Hungarian</b> , <b>Italian</b> , <b>Japanese</b> , <b>Korean</b> , <b>Norwegian</b> , <b>Polish</b> , <b>Romanian</b> , <b>Russian</b> , <b>Slovak</b> , <b>Swedish</b> and <b>Turkish</b> .	The default is English.
Menu Location	Sets the menu position on screen from <b>Top Left</b> , <b>Top Right</b> , <b>Center</b> , <b>Bottom Left</b> or <b>Bottom Right</b> .	The default is Center.

APPENDIX C  
ADJUSTING PROJECTOR SETTINGS

Setting	Use	Notes
Closed caption	Turns on or turns off the closed captioning feature ( <b>Off</b> , <b>CC1</b> , <b>CC2</b> , <b>CC3</b> and <b>CC4</b> ).	The default is off. Closed caption applies only to Composite NTSC input sources.
VGA Out (Standby)	Turns on or turns off the VGA out terminal.	The default is off.
Test Pattern	Turns on or turns off a projected circle pattern.	
Startup Logo	Turns on or turns off a startup logo when the projector lamp is starting and a video source signal isn't displayed.	The default is on.
UART Mode	Sets <b>LAN</b> terminal or the <b>RS 232</b> terminal for projector control.	The default is LAN.
LAN	Turns on or turns off the LAN terminal.	The default is off.
Reset	Resets projector settings to their default values.	If you select <b>Yes</b> , all settings return to the default values, reversing any menu changes you made. This action is irreversible. Don't adjust this setting unless you want to reset all of the applied settings, or unless you're advised to by a SMART Support specialist.
 <b>Audio menu</b>		
Mute	Mutes the projector's audio output.	The default is off. If you mute the projector's audio output and then increase or decrease the volume, the volume is restored automatically. You can prevent this from happening by disabling the volume control.
Volume	Sets the projector's volume amplification from 0 to 32.	The default is 20.
In Standby Mode	Turns on or turns off audio output when the projector is in standby mode.	The default is off.
 <b>Options menu</b>		
Auto Source	Turns on or turns off signal searching of input connectors.	The default is on.

APPENDIX C  
**ADJUSTING PROJECTOR SETTINGS**

Setting	Use	Notes
		Select <b>On</b> to have the projector continuously switch inputs until it finds an active video source. Select <b>Off</b> to maintain signal detection in one input.
Input	Sets the video source ( <b>HDMI 1, VGA 1, VGA 2</b> or <b>Video 1</b> ).	The default is HDMI.
Auto Power Off	Sets the length of the auto power-off countdown timer between 0 to 120 minutes in five minute increments.	The default is 15 minutes. The timer begins to count down when the projector no longer receives a video signal. The timer finishes when the projector enters Standby mode. Select <b>0</b> to turn off the timer.
Lamp Settings	Displays the lamp settings on the projector.	
High Altitude	Turns on or turns off high fan speed.	The default is off.
Dust Filter Reminder	Sets the dust filter reminder settings.	

APPENDIX C  
ADJUSTING PROJECTOR SETTINGS

Setting	Use	Notes
Information	Provides the Model Name, Source, Resolution, Software Version, Color Space and Aspect Ratio	
<b>Lamp Settings sub-menu</b>		
Lamp Hours Used (Normal)	Displays the number of lamp hours while in Normal mode.	
Lamp Hours Used (ECO)	Displays the number of lamp hours while in Eco mode.	
Lamp Life Reminder	Turns on or turns off the lamp replacement reminder.	This reminder appears 100 hours before the recommended lamp replacement.
Lamp Power Mode	Sets the lamp power mode ( <b>Normal</b> , <b>Auto</b> , <b>ECO1</b> or <b>ECO2</b> ).	The default is Normal. <b>Normal</b> displays a high-quality, bright image. <b>ECO1</b> and <b>ECO2</b> increases the lamp life by decreasing the brightness of the image. <b>Auto</b> enables ImageCare mode which improves lamp life under most circumstances.
Clear Lamp Hours	Resets the lamp hours.	Always reset the lamp hours after you replace a lamp, because lamp service reminders are based on the current hours of use. See <i>Resetting the lamp hours</i> on page 29 for details on the lamp hours reset procedure.
<b>Filters Remind (Hour) sub-menu</b>		
Filters Remind (Hour)	Sets a reminder to clean the filter (0 to 1000 hours).	The default is 0 hours.
Cleaning Up Reminder	Turns on or turns off the filter reminder.	The default is off.
 <b>LAN Menu</b>		
DHCP	Displays the status of the network's Dynamic Host Configuration Protocol (DHCP) as <b>On</b> or <b>Off</b> .	The default is on. <b>On</b> enables a DHCP server on the network to automatically assign an IP address to the projector. <b>Off</b> enables an administrator to assign an IP address manually.

APPENDIX C  
**ADJUSTING PROJECTOR SETTINGS**

Setting	Use	Notes
IP Address	Displays the projector's current IP address in values between 0.0.0.0 and 255.255.255.255.	To assign the projector's IP address, use the projector's web page to enter an address or use a DHCP server to assign a dynamic IP address (see <i>Remotely managing your system through a network interface</i> on page 45).
Subnet Mask	Displays the projector's subnet mask number in values between 0.0.0.0 and 255.255.255.255.	
Gateway	Displays the projector's default network gateway in values between 0.0.0.0 and 255.255.255.255.	
DNS	Displays the projector's primary domain name server (DNS) IP address in values between 0.0.0.0 and 255.255.255.255.	
Store	Stores the values you entered.	
Reset	Resets values in the LAN menu to their default values.	If you select <b>Yes</b> , all LAN settings reset to their defaults, reversing any menu changes you made. This action is irreversible. Don't adjust this setting unless you want to reset all of the applied settings, or unless you're advised to by a SMART Support specialist.

## Appendix D

# Integrating other devices

Video format .....	61
Native video format .....	61
Video format compatibility .....	62
HD and SD signal format compatibility .....	63
Video system signal compatibility .....	64
Connecting peripheral sources and outputs .....	64

---

This appendix provides information on integrating your SMART Board interactive whiteboard system with peripheral devices.

## Video format

Your projector has a native video format and various video format compatibility modes. You can change image appearances for certain formats and compatibilities.

### Native video format

The following table lists the native VESA RGB video format and digital HDMI video format for the projector.

Resolution	Mode	Aspect ratio	Refresh rate (Hz)	Horizontal frequency (kHz)	Pixel clock (MHz)
1280 × 800	WXGA	16:10	60	48	83.5

## Video format compatibility

The following tables list the projector's compatible VESA RGB video formats by resolution, which you can adjust by using the aspect ratio commands described in *Adjusting projector settings* on page 55.

Resolution	Mode	Aspect ratio	Refresh rate (Hz)	"Match Input" appearance
720 × 400	720×400_85	1.8:1	85.039	Pillarbox
640 × 480	VGA 60	4:3	59.94	Pillarbox
640 × 480	VGA 72	4:3	72.809	Pillarbox
640 × 480	VGA 75	4:3	75	Pillarbox
640 × 480	VGA 85	4:3	85.008	Pillarbox
800 × 600	SVGA 56	4:3	56.25	Pillarbox
800 × 600	SVGA 60	4:3	60.317	Pillarbox
800 × 600	SVGA 72	4:3	72.188	Pillarbox
800 × 600	SVGA75	4:3	75	Pillarbox
800 × 600	SVGA 85	4:3	85.061	Pillarbox
832 × 624	MAC 16"	4:3	74.55	Pillarbox
1024 × 768	XGA 60	4:3	60.004	Pillarbox
1024 × 768	XGA 70	4:3	70.069	Pillarbox
1024 × 768	XGA 75	4:3	75.029	Pillarbox
1024 × 768	XGA 85	4:3	84.997	Pillarbox
1024 × 768	MAC 19"	4:3	74.7	Pillarbox
1152 × 864	SXGA175	4:3	75	Pillarbox
1280 × 768	SXGA175	1.67:1	60	Letterbox
1280 × 800	WXGA	16:10	60	Native
1280 × 960	Quad VGA 60	4:3	60	Pillarbox
1280 × 960	Quad VGA 85	4:3	85.002	Pillarbox
1280 × 1024	SXGA3 60	5:4	60.02	Pillarbox
1280 × 1024	SXGA3 75	5:4	75.025	Pillarbox



Resolution	Mode	Aspect ratio	Refresh rate (Hz)	“Match Input” appearance
1280 × 1024	SXGA3 85	5:4	85.024	Pillarbox
1400 × 1050	SXGA+	4:3	59.978	Pillarbox
1600 × 1200	UXGA	4:3	60	Pillarbox
1680 × 1050	WSXGA+	16:10	60	Native
1920 × 1080	HD 1080	16:9	60	Letterbox

## HD and SD signal format compatibility

The following tables list the projector’s high definition and standard definition format signal compatibility, which you can adjust by using the aspect ratio commands described in *Adjusting projector settings* on page 55.

Signal format	Aspect ratio	Horizontal frequency (kHz)	Vertical frequency (Hz)	“Match Input” appearance
480i (525i)	4:3	15.73	59.94	Full screen
480p (525p)	4:3	31.47	59.94	Full screen
576i (625i)	5:4	15.63	50	Pillarbox
576p (625p)	5:4	31.25	50	Pillarbox
720p (750p)	16:9	45	59.94	Letterbox
720p (750p)	16:9	37.5	50	Letterbox
1080i (1125i)	16:9	33.75	59.94	Letterbox
1080i (1125i)	16:9	28.13	50	Letterbox
1080p (1125p)	16:9	67.5	59.94	Letterbox
1080p (1125p)	16:9	56.25	50	Letterbox

### NOTE

Your projector is HD-ready. Its native resolution supports a pixel-perfect display of 720p source content. However, because the projector compresses 1080p source content to fit its native resolution, it doesn’t support a pixel-perfect display of 1080p source content.

## Video system signal compatibility

The following tables list the projector's video system signal compatibility delivered over HDMI video connectors, which you can adjust by using the aspect ratio commands described in *Adjusting projector settings* on page 55.

Video mode	Aspect ratio	Vertical frequency (Hz)
720p	16:9	59.94
720p	16:9	50
1080i	16:9	50
1080p	16:9	50.94
1080p	16:9	50
576i	5:4	50
480i	4:3	50.94

## Connecting peripheral sources and outputs

Follow these instructions if you have a peripheral device to connect to your interactive whiteboard system, such as a DVD/Blu-ray player.

### NOTE

Measure the distance between the projector and the peripheral device you want to connect. Make sure each cable is long enough, has plenty of slack and can be placed safely in your room without presenting a trip hazard.

■ To connect a peripheral source or output to your projector

1. Connect your peripheral device's input cables to the projector.
2. Switch input sources to the peripheral device by pressing the **Input** button on the remote control.

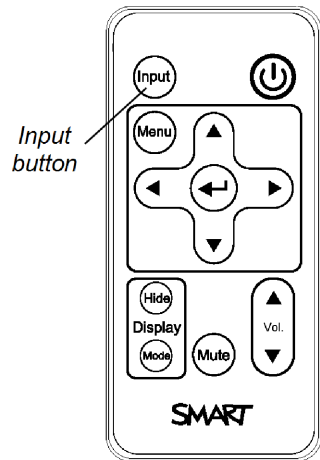



## Appendix E

# Remote control code definitions

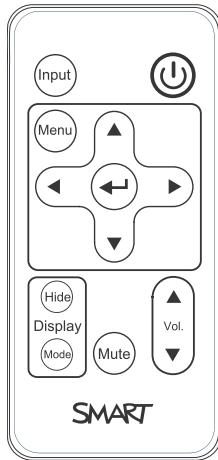

IR signal format: NEC1

Key	Repeat format	Vendor code		Key code	
		Byte 1	Byte 2	Byte 3	Byte 4
Input	F1	8B	CA	14	EB
Power (⏻)	F1	8B	CA	12	ED
Menu	F1	8B	CA	1B	E4
Up (▲)	F1	8B	CA	40	BF
Left (◀)	F1	8B	CA	42	BD
Enter (↵)	F1	8B	CA	13	EC
Right (▶)	F1	8B	CA	43	BC
Down (▼)	F1	8B	CA	41	BE
Hide	F1	8B	CA	15	EA
Volume up (▲)	F1	8B	CA	44	BB
Mode	F1	8B	CA	45	BA
Mute	F1	8B	CA	11	EE
Volume down (▼)	F1	8B	CA	46	B9



## Appendix F

# Hardware environmental compliance

SMART Technologies supports global efforts to ensure that electronic equipment is manufactured, sold and disposed of in a safe and environmentally friendly manner.

## Waste Electrical and Electronic Equipment and Battery regulations (WEEE and Battery Directives)

Electrical and electronic equipment and batteries contain substances that can be harmful to the environment and to human health. The crossed-out wheeled bin symbol indicates that products should be disposed of in the appropriate recycling stream and not as regular waste.



## Batteries

Remote contains CR2025 battery. Recycle or dispose of batteries properly.

## Perchlorate material

Contains perchlorate material. Special handling may apply. See [dtsc.ca.gov/hazardouswaste/perchlorate](https://dtsc.ca.gov/hazardouswaste/perchlorate).

## Mercury

The lamp in this product contains mercury and must be recycled or disposed in accordance with local, state, provincial and federal laws.



## More information

See [smarttech.com/compliance](https://smarttech.com/compliance) for more information.





# Index

## 3

3.5 mm audio connectors 12

## A

accessories

included 5

optional 5

air filters

cleaning 31

aspect ratios 2, 61-64

audio

muting 16

resolving issues with 42

## B

batteries 30, 69

Blu-ray players 64

## C

cameras 64

color mode 18, 55

connection diagrams

projector 12

## D

DHCP 22, 47, 59

display modes 16

DNS 47

document cameras 64

dust iv

DVD players 64

## E

electrostatic discharge iv

emissions v

environmental requirements iv

## F

fans 37

flickering 40

focus 10

## H

HD signal compatibility 63

head space clearance 8

height 8

humidity iv

## I

image

adjusting 10

focusing 10

resolving issues with 39

image alignment screen 10

installation

choosing a height 8

choosing a location 8

interactive whiteboard

about 3-4

maintaining 25

using 24

IP address 23, 45, 47, 60

## L

- lamp module
  - cleaning 27
  - resolving issues with 38
- laptop computers
  - troubleshooting issues with 41
- letterboxing 62-63
- light sources 8
- location 8

## M

- MAC support 62
- mercury 69
- mounting template 8
- mute control 16, 20, 57

## N

- native video formats 61
- network communication 12, 43, 47, 49

## O

- options 5
- original packaging 44

## P

- passwords 43
- pen ledge
  - cleaning 26
- Perchlorate material 69
- peripheral sources 64
- pillarboxing 62-63
- power 12
- projector
  - about 2
  - adjusting settings for 18, 55
  - adjusting the image of 10

- cleaning 27
- connection diagram for 12
- focusing the image of 10
- installing 7
- lights and status of 34
- locating the serial number on 34
- remotely managing 45, 51
- routing cables from 13
- using your remote control with 15
- video format compatibility for 61

## Q

- quad VGA support 62

## R

- refresh rates 61-62
- remote control
  - code definitions for 67
  - installing the battery 30
  - using the buttons 16
- RJ45 connector 12
- room control 45, 51
- RS-232 serial interface 12, 52

## S

- SD signal compatibility 63
- serial interface See RS-232 serial interface
- serial number 34
- signal loss 39
- SMART Board interactive
  - whiteboard See interactive
  - whiteboard
- SMART UX80 projector See projector
- sound See audio
- subnet mask 23, 47, 60
- SVGA support 62
- SXGA support 62

## INDEX

### T

- temperatures (interactive whiteboard),  
operating and storage iv
- temperatures (projector), operating and  
storage iv
- transportation 44
- troubleshooting 33

### U

- USB receptacles 12
- UX80 projector See projector
- UXGA support 62

### V

- VGA support 62
- video
  - format compatibility for 61

### W

- warnings iii
- water and fluid resistance iv
- web page management 45
- WEEE and Battery Directives 69
- whiteboard See interactive whiteboard

### X

- XGA support 62





**SMART TECHNOLOGIES**

[smarttech.com/support](https://smarttech.com/support)

[smarttech.com/contactsupport](https://smarttech.com/contactsupport)

[smarttech.com/kb/170782](https://smarttech.com/kb/170782)