



ES500/EX50 I
Digital Projector
User Manual

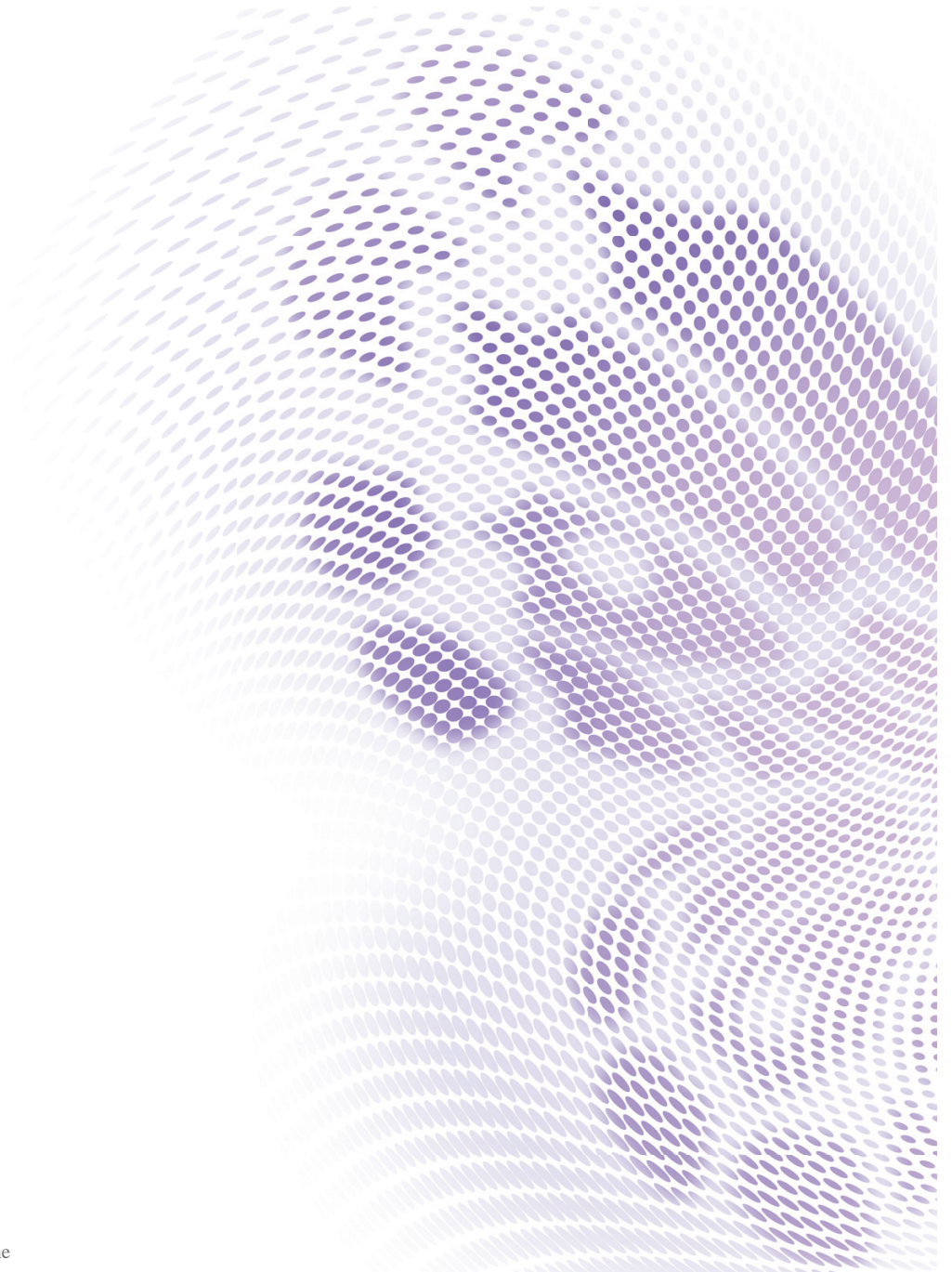

Table of contents

Important safety instructions 3

Introduction..... 7

Projector features.....	7
Shipping contents.....	8
Projector exterior view.....	10

Positioning your projector 16

Choosing a location.....	16
Obtaining a preferred projected image size.....	17

Connection 18

Connecting a computer or monitor...	19
Connecting Video source devices.....	19

Operation 21

Starting up the projector	21
Adjusting the projected image	22
Using the menus.....	25
Securing the projector	26
Switching input signal	29
Magnifying and searching for details ...	30
Selecting the aspect ratio	31
Optimizing the image	32
Setting the presentation timer	36
Remote paging operations	37
Hiding the image.....	38
Freezing the image	38
Operating in a high altitude environment.....	39
Use Teaching Template	40
Personalizing the projector menu display	41
Select the lamp saver mode.....	41

Shutting down the projector	42
Menu operation	43

Maintenance 56

Care of the projector.....	56
Lamp information	57

Troubleshooting..... 64

Specifications..... 65

Dimensions	66
Ceiling mount installation.....	66
Timing chart.....	67

Warranty and Copyright information..... 69

Important safety instructions

Your projector is designed and tested to meet the latest standards for safety of information technology equipment. However, to ensure safe use of this product, it is important that you follow the instructions mentioned in this manual and marked on the product.

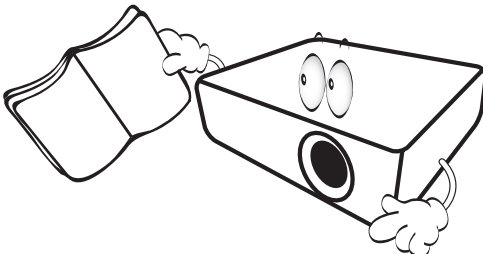
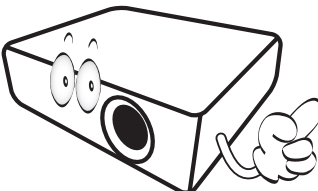
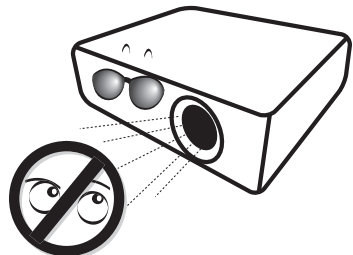
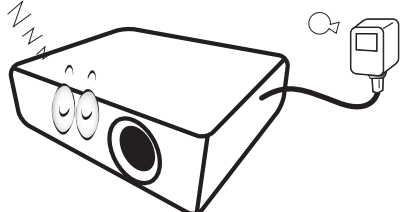
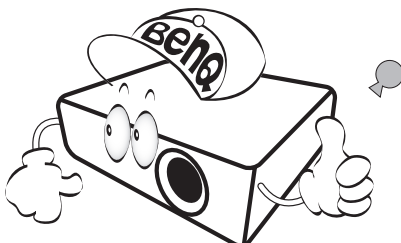
Safety Instructions	
<p>1. Please read this manual before you operate your projector. Save it for future reference.</p> 	<p>4. Always open the lens shutter or remove the lens cap when the projector lamp is on.</p> 
<p>2. Do not look straight at the projector lens during operation. The intense light beam may damage your eyes.</p> 	<p>5. In some countries, the line voltage is NOT stable. This projector is designed to operate safely within a mains voltage between 100 to 240 volts AC, but could fail if power cuts or surges of ± 10 volts occur. In areas where the mains voltage may fluctuate or cut out, it is recommended that you connect your projector through a power stabilizer, surge protector or uninterruptible power supply (UPS).</p> 
<p>3. Refer servicing to qualified service personnel.</p> 	<p>6. Do not block the projection lens with any objects when the projector is under operation as this could cause the objects to become heated and deformed or even cause a fire.</p>

Safety Instructions (Continued)

7. The lamp becomes extremely hot during operation. Allow the projector to cool for approximately 45 minutes prior to removing the lamp assembly for replacement.

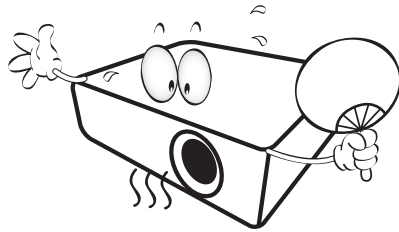

8. Do not operate lamps beyond the rated lamp life. Excessive operation of lamps beyond the rated life could cause them to break on rare occasions.

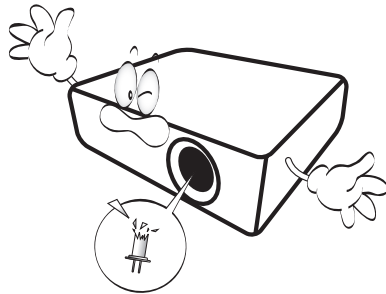

9. Never replace the lamp assembly or any electronic components unless the projector is unplugged.

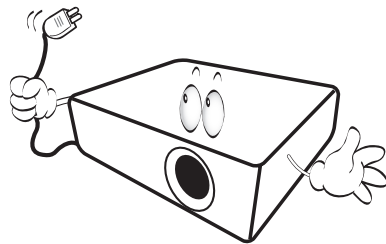

10. Do not place this product on an unstable cart, stand, or table. The product may fall, sustaining serious damage.

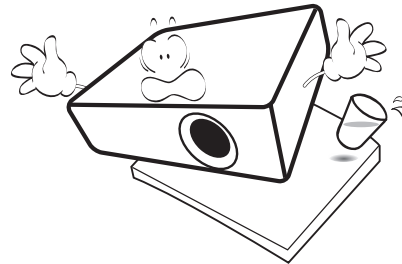

11. Do not attempt to disassemble this projector. There are dangerous high voltages inside which may cause death if you should come into contact with live parts.

Under no circumstances should you ever undo or remove any other covers. Refer servicing only to suitably qualified professional service personnel.

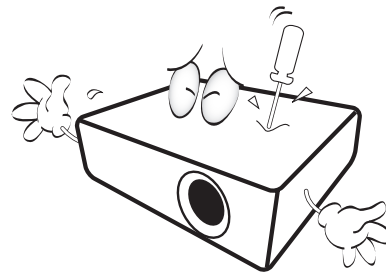

12. When the projector is under operation, you may sense some heated air and odor from its ventilation grill. It is a normal phenomenon and not a product defect.

Safety Instructions (Continued)

13. Do not place this projector in any of the following environments.

- Space that is poorly ventilated or confined. Allow at least 50 cm clearance from walls and free flow of air around the projector.
- Locations where temperatures may become excessively high, such as the inside of a car with all windows rolled up.
- Locations where excessive humidity, dust, or cigarette smoke may contaminate optical components, shortening the projector's life span and darkening the image.

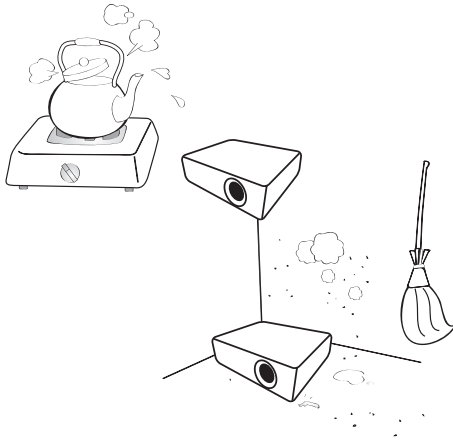

- Locations near fire alarms
- Locations with an ambient temperature above 40°C / 104°F
- Locations where the altitudes are higher than 3000 m (10000 feet).

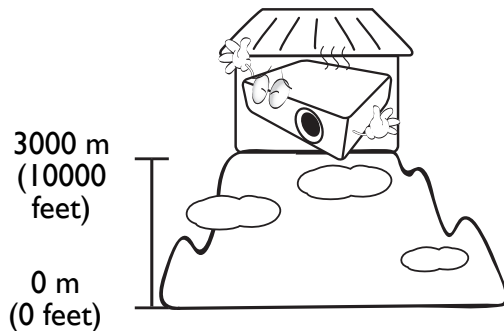

14. Do not block the ventilation holes.

- Do not place this projector on a blanket, bedding or any other soft surface.
- Do not cover this projector with a cloth or any other item.
- Do not place inflammables near the projector.

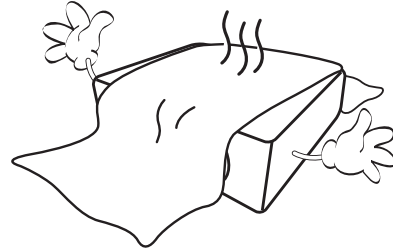

If the ventilation holes are seriously obstructed, overheating inside the projector may result in a fire.

15. Always place the projector on a level, horizontal surface during operation.

- Do not use if tilted at an angle of more than 10 degrees left to right, nor at angle of more than 15 degrees front to back. Using the projector when it is not fully horizontal may cause a malfunction of, or damage to, the lamp.

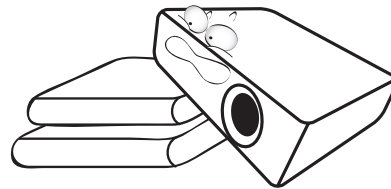

Safety Instructions (Continued)

16. Do not stand the projector on end vertically. Doing so may cause the projector to fall over, causing injury or resulting in damage to the projector.

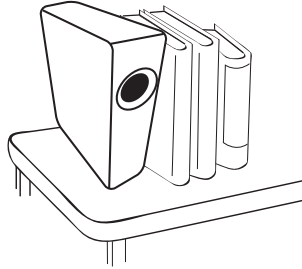

17. Do not step on the projector or place any objects upon it. Besides probable physical damage to the projector, doing so may result in accidents and possible injury.

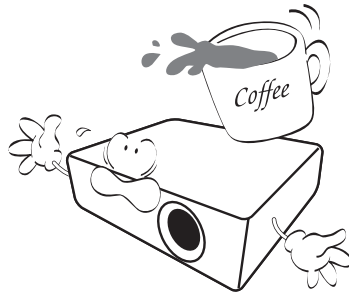

18. Do not place liquids near or on the projector. Liquids spilled into the projector may cause it to fail. If the projector does become wet, disconnect it from the power supply's wall socket and call BenQ to have the projector serviced.

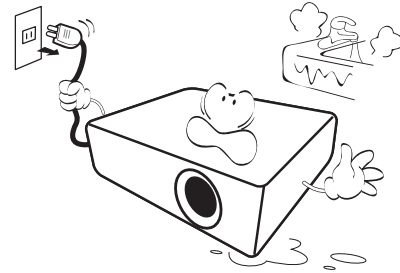

19. This product is capable of displaying inverted images for ceiling mount installation.



Use only BenQ's Ceiling Mount Kit for mounting the projector and ensure it is securely installed.

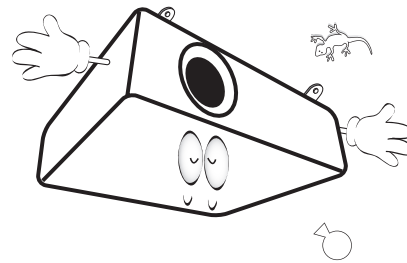

Introduction

Projector features

This model is one of the best projectors available in the world. You can enjoy the best performance video quality with up to 300-inch projection across various devices such as PC, laptop, DVD and VCR even document camera to bring all possibility to life.

The projector offers the following features

- **SmartEco™ starts your dynamic power saving**
SmartEco™ technology saves lamp power consumption depending on the content brightness level when SmartEco mode is selected
 - **Longest hours lamp life with SmartEco™ technology**
SmartEco™ technology increases the lamp life hours when selecting SmartEco mode to lower the power consumption
 - **ECO BLANK saves lamp power**
Pressing the ECO BLANK bottom to immediately hide the image, lowering the lamp power at the same time your image is hiding
 - **Less than 0.5W in standby condition**
Less than 0.5W power consumption under standby mode
 - **Filter Free**
Filter free design to lower maintenance and operating costs.
 - **One-key auto-adjustment**
Pressing AUTO on the keypad or remote control to show the best picture quality immediately
 - **Quick Cooling, Auto Power Off, Direct Power On**
Quick Cooling function speeds up the cooling process when turning off the projector. Auto Power Off function allows the projector to turn off automatically if no input signal is detected after a set period of time. Direct Power On turns your projector when the power is fed.
 - **Instant Restart**
Selectable Instant Restart function enables you to restart the projector immediately within 90 seconds after turning it off.
 - **3D Function supported**
Various 3D formats make the 3D function more flexible. By presenting the depth of the images, you can wear BenQ 3D gassed to enjoy the 3D movies, videos and sporting events in a more realistic way.
-  • **The apparent brightness of the projected image will vary depending on the ambient lighting conditions, selected input signal contrast/ brightness settings, and is proportional to projection distance.**
- **The lamp brightness will decline over time and may vary within the lamp manufacturers specifications. This is normal and expected behavior.**

Shipping contents

Carefully unpack and verify that you have all of the items shown below. If any of these items are missing, please contact your place of purchase.

Standard accessories

 The supplied accessories will be suitable for your region, and may differ from those illustrated.

***The warranty card is only supplied in some specific regions. Please consult your dealer for detailed information.**

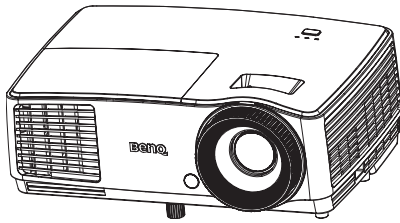

Projector

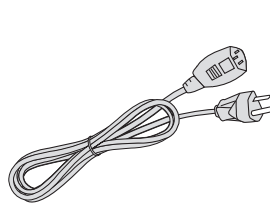

Power cord

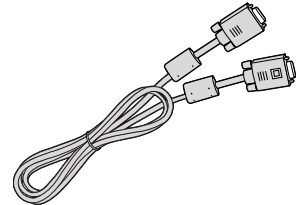

VGA cable



Quick start guide



User manual CD

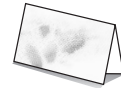

Warranty card*

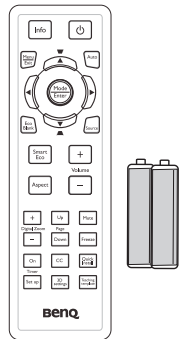

Remote control with battery

Optional accessories

1. Spare lamp kit
2. Ceiling mount kit
3. Carry bag
4. 3D glasses
5. Presentation plus

Projector exterior view

Front/upper side

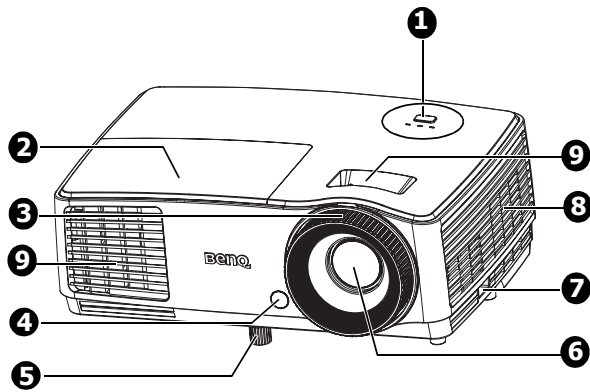

1. External control panel
(See "Projector" on page 11 for details.)
2. Lamp cover
3. Focus ring
4. Front IR remote sensor
5. Elevator foot
6. Projection lens
7. Kensington anti-theft lock slot
8. Vent holes
9. Zoom ring
10. RGB (PC)/Component video (YPbPr/ YCbCr) signal input jack
11. RS-232 control port
12. Video input jack
13. Mini-B USB input jack
14. AC power cord inlet
15. Rear adjuster foot
16. Ceiling mount holes

Rear/lower side

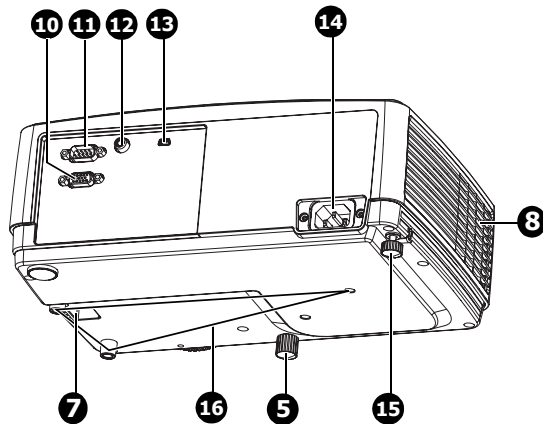

Controls and functions

Projector

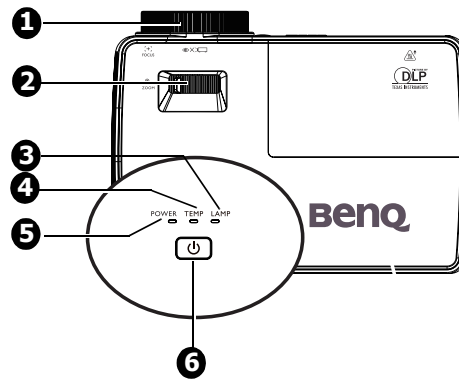

- 1. Focus ring**
Adjusts the focus of the projected image. See ["Fine-tuning the image size and clarity" on page 24](#) for details.
- 2. Zoom ring**
Adjusts the size of the image. See ["Fine-tuning the image size and clarity" on page 24](#) for details.
- 3. LAMP indicator light**
Indicates the status of the lamp. Lights up or flashes when the lamp has developed a problem. See ["Indicators" on page 63](#) for details.
- 4. TEMP(temperature) warning light**
Lights up red if the projector's temperature becomes too high. See ["Indicators" on page 63](#) for details.
- 5. POWER indicator light**
Lights up or flashes when the projector is under operation. See ["Indicators" on page 63](#) for detail.
- 6.  POWER**
Toggles the projector between standby mode and on. See ["Starting up the projector" on page 21](#) and ["Shutting down the projector" on page 42](#) for details.

Ceiling mounting the projector

We want you to have a pleasant experience using your BenQ projector, so we need to bring this safety matter to your attention to prevent possible damage to person and property.

If you intend to mount your projector on the ceiling, we strongly recommend that you use a proper fitting BenQ projector ceiling mount kit and that you ensure it is securely and safely installed.

If you use a non-BenQ brand projector ceiling mount kit, there is a safety risk that the projector may fall from the ceiling due to an improper attachment through the use of the wrong gauge or length screws.

You can purchase a BenQ projector ceiling mount kit from the place you purchased your BenQ projector. BenQ recommends that you also purchase a separate Kensington lock compatible security cable and attach it securely to both the Kensington lock slot on the projector and the base of the ceiling mount bracket. This will perform the secondary role of restraining the projector should its attachment to the mounting bracket become loose.

Remote control

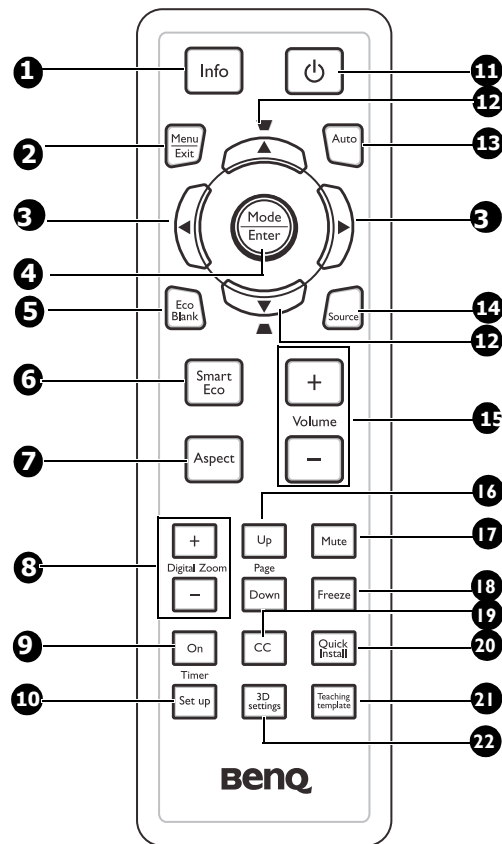

1. **Info**
Showing the status information of the projector.
2. **Menu/Exit**
Turns on the On-Screen Display (OSD) menu. Goes back to previous OSD menu, exits and saves menu settings. See ["Using the menus" on page 25](#) for details.
3. **◀ Left/▶ Right**
When the On-Screen Display (OSD) menu is activated, the #3 and #12 keys are used as directional arrows to select the desired menu items and to make adjustments. See ["Using the menus" on page 25](#) for details.
4. **Mode/Enter**
Selects an available picture setup mode. See ["Selecting a picture mode" on page 32](#) for details.
Activates the selected On-Screen Display (OSD) menu item. See ["Using the menus" on page 25](#) for details.
5. **Eco Blank**
Press the Eco Blank button to turn off the image for a period of time with 70% lamp power saving. Press again to restore the image. See ["Hiding the image" on page 38](#) for details.
6. **Smart Eco**
Displays the lamp mode selection bar (Normal/Economic/SmartEco).
7. **Aspect**
Selects the display aspect ratio. See ["About the aspect ratio" on page 31](#) for details.
8. **Digital Zoom keys (+, -)**
Magnifies or reduces the projected picture size. See ["Magnifying and searching for details" on page 30](#) for details.
9. **Timer On**
Activates or displays an on-screen timer based on your own timer setting. See ["Setting the presentation timer" on page 36](#) for details.
10. **Timer Setup**
Enters presentation timer setting directly. See ["Setting the presentation timer" on page 36](#) for details.

11. **Power**
Toggles the projector between standby mode and on. See ["Starting up the projector"](#) on page 21 and ["Shutting down the projector"](#) on page 42 for details.
12. **Keystone/Arrow keys (▼ / ▲ Up, ▲ / ▼ Down)**
Manually corrects distorted images resulting from an angled projection. See ["Correcting keystone"](#) on page 24 for details.
13. **Auto**
Automatically determines the best picture timings for the displayed image. See ["Auto-adjusting the image"](#) on page 23 for details.
14. **Source**
Displays the source selection bar. See ["Switching input signal"](#) on page 29 for details.
15. **Volume +/-**
No function for this model.
16. **Page Up/Down**
Page up/down arrows when connected through USB to a PC. See ["Remote paging operations"](#) on page 37 for details.
17. **Mute**
No function for this model.
18. **Freeze**
Freezes the projected image. See ["Freezing the image"](#) on page 38 for details.
19. **CC**
Display the video term description on screen which is provided for hard-of-hearing viewers.
20. **Quick Install**
A menu shortcut that includes Test Pattern, Projector Installation and Keystone.
21. **Teaching Template**
Displays the selectable bar for teachers choosing the template as his/her suitable teaching background. See ["Use Teaching Template"](#) on page 40 for details.
22. **3D Settings**
Activates the 3D On-Screen Display (OSD) menu item.

Infra-Red (IR) remote control sensor is located on the front of the projector. The remote control must be held at an angle within 30 degrees perpendicular to the projector's IR remote control sensor to function correctly. The distance between the remote control and the sensor should not exceed 8 meters (~ 26 feet).

Make sure that there are no obstacles between the remote control and the IR sensor on the projector that might obstruct the infra-red beam.

- **Operating the projector from the front**

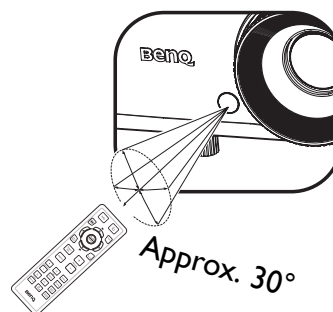

Replacing the remote control battery

1. To open the battery cover, turn the remote control over to view its back, push on the finger grip on the cover and slide it up in the direction of the arrow as illustrated. The cover will slide off.
2. Remove any existing batteries (if necessary) and install two AAA batteries observing the battery polarities as indicated in the base of the battery compartment. Positive (+) goes to positive and negative (-) goes to negative.
3. Refit the cover by aligning it with the base and sliding it back down into position. Stop when it clicks into place.

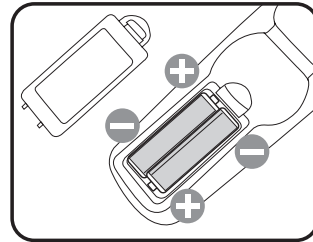
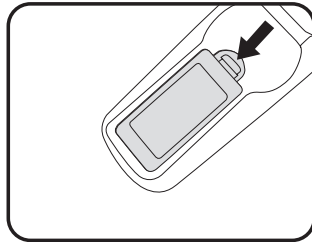

- ⚠ • **Avoid excessive heat and humidity.**
- **There may be battery damage if the battery is incorrectly replaced.**
- **Replace only with the same or equivalent type recommended by the battery manufacturer.**
- **Dispose of the used battery according to the battery manufacturer's instructions.**
- **Never throw a battery into a fire. There may be danger of an explosion.**
- **If the battery is dead or if you will not be using the remote control for a long time, remove the battery to prevent damage to the remote control from possible battery leakage.**

Positioning your projector

Choosing a location

Your room layout or personal preference will dictate which installation location you select. Take into consideration the size and position of your screen, the location of a suitable power outlet, as well as the location and distance between the projector and the rest of your equipment.

Your projector is designed to be installed in one of four possible installation locations:

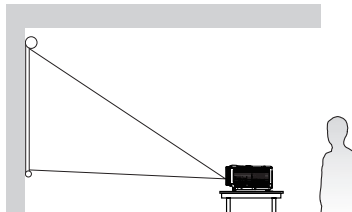
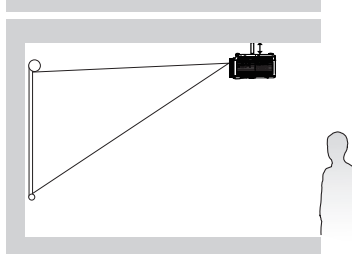
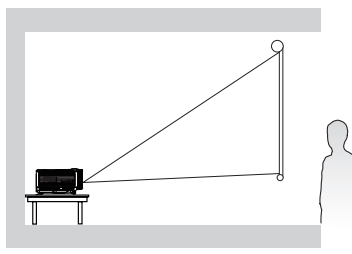
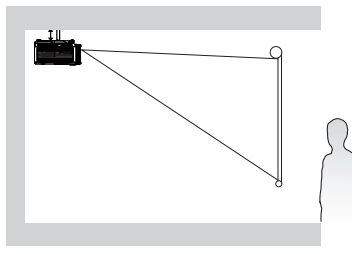
<p>1. Front Table</p> <p>Select this location with the projector placed near the floor in front of the screen. This is the most common way to position the projector for quick setup and portability.</p>	
<p>2. Front Ceiling</p> <p>Select this location with the projector suspended upside-down from the ceiling in front of the screen.</p> <p>Purchase the BenQ Projector Ceiling Mounting Kit from your dealer to mount your projector on the ceiling.</p> <p>Set Front Ceiling in the SYSTEM SETUP: Basic > Projector Installation menu after you turn the projector on.</p>	
<p>3. Rear Table</p> <p>Select this location with the projector placed near the floor behind the screen.</p> <p>Note that a special rear projection screen is required.</p> <p>Set Rear Table in the SYSTEM SETUP: Basic > Projector Installation menu after you turn the projector on.</p>	
<p>4. Rear Ceiling</p> <p>Select this location with the projector suspended upside-down from the ceiling behind the screen.</p> <p>Note that a special rear projection screen and the BenQ Projector Ceiling Mounting Kit are required for this installation location.</p> <p>Set Rear Ceiling in the SYSTEM SETUP: Basic > Projector Installation menu after you turn the projector on.</p>	

Obtaining a preferred projected image size

The distance from the projector lens to the screen, the zoom setting (if available), and the video format each factors in the projected image size.

Projection dimensions

Refer to "Dimensions" on page 66 for the center of lens dimensions of this projector before calculating the appropriate position.

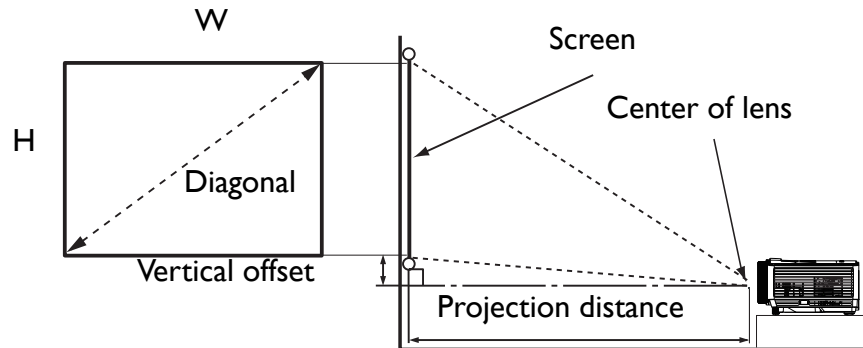

The screen aspect ratio is 4:3 and the projected picture is 4:3

Screen size			Projection distance (mm)			Vertical offset (mm)	
Diagonal		W (mm)	H (mm)	Min distance	Average		Max distance
Inch	mm			(max. zoom)			(min. zoom)
35	889	711	533	1401	1472	1543	80
40	1016	813	610	1600	1680	1760	91
50	1270	1016	762	2000	2100	2200	114
60	1524	1219	914	2400	2520	2640	137
80	2032	1626	1219	3200	3360	3520	183
100	2540	2032	1524	4000	4200	4400	229
120	3048	2438	1829	4800	5040	5280	274
150	3810	3048	2286	6000	6300	6600	343
200	5080	4064	3048	8000	8400	8800	457
220	5588	4470	3353	8800	9240	9680	503
250	6350	5080	3810	10000	10500	11000	572
300	7620	6096	4572	12000	12600	13200	686

For example, if you are using a 120-inch screen, the average projection distance is 5040 mm and with a vertical offset of 274 mm.

If your measured projection distance is 5.0 m (5000 mm), the closest match in the "Projection distance (mm)" column is 5040 mm. Looking across this row shows that a 120" (about 3.0 m) screen is required.

ⓘ All measurements are approximate and may vary from the actual sizes. BenQ recommends that if you intend to permanently install the projector, you should physically test the projection size and distance using the actual projector in situ before you permanently install it, so as to make allowance for this projector's optical characteristics. This will help you determine the exact mounting position so that it best suits your installation location.

Connection

When connecting a signal source to the projector, be sure to:

1. Turn all equipment off before making any connections.
2. Use the correct signal cables for each source.
3. Ensure the cables are firmly inserted.

- **In the connections shown below, some cables may not be included with the projector (see "Shipping contents" on page 8). They are commercially available from electronics stores.**
- **For detailed connection methods, see pages 19-20.**

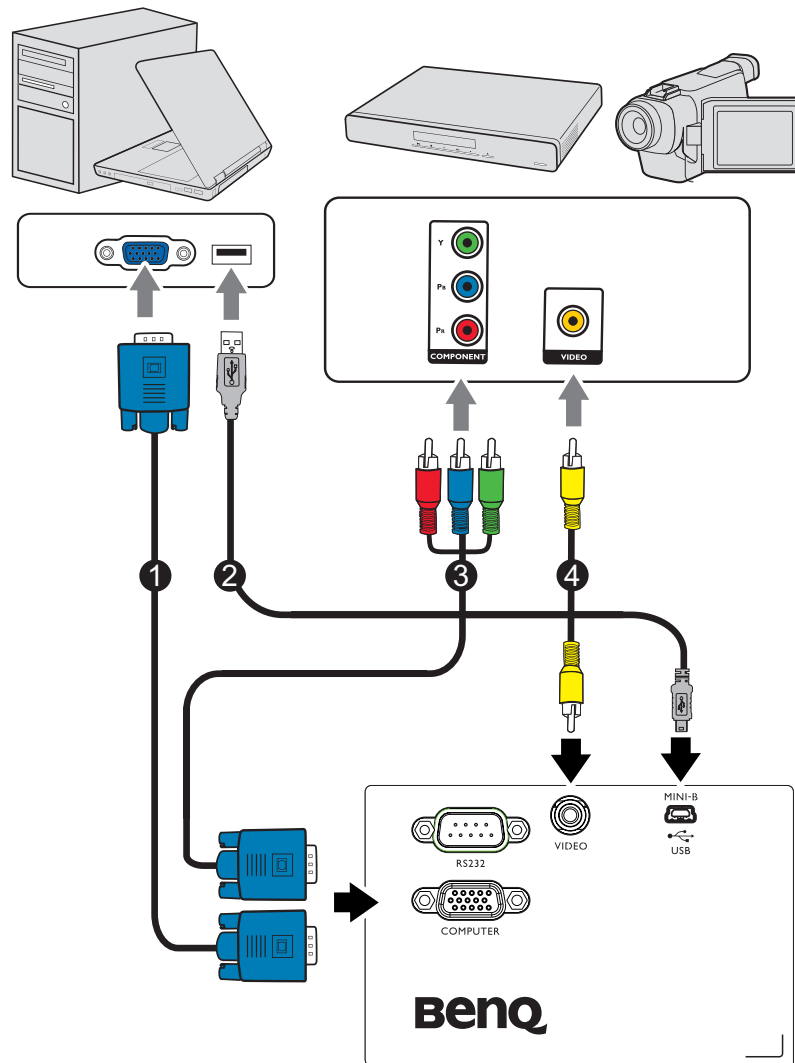

1. VGA cable	2. USB Cable
3. Component Video to VGA (DSub) adapter cable	4. Video cable

Connecting a computer or monitor

Connecting a computer

The projector can connect to both IBM® compatibles and Macintosh® computers. A Mac adapter is needed if you are connecting legacy version Macintosh computers.



To connect the projector to a notebook or desktop computer:

1. Take the supplied VGA cable and connect one end to the D-Sub output socket of the computer.
2. Connect the other end of the VGA cable to the **COMPUTER** signal input jack on the projector.

 **Many notebooks do not turn on their external video ports when connected to a projector. Usually a key combo like FN + F3 or CRT/LCD key turns the external display on/off. Locate a function key labeled CRT/LCD or a function key with a monitor symbol on the notebook. Press FN and the labeled function key simultaneously. Refer to your notebook's documentation to find your notebook's key combination.**

Connecting Video source devices

You need only connect the projector to a Video source device using just one of the above connecting methods, however each provides a different level of video quality. The method you choose will most likely depend upon the availability of matching terminals on both the projector and the Video source device as described below:

Terminal name	Terminal appearance	Reference	Picture quality
Component Video	COMPUTER 	"Connecting a Component Video source device" on page 20	Better
Video	VIDEO 	"Connecting a Composite source device" on page 20	Good

Connecting a Component Video source device

Examine your Video source device to determine if it has a set of unused Component Video output jacks available:

- **If so, you can continue with this procedure.**
- **If not, you will need to reassess which method you can use to connect to the device.**

To connect the projector to a Component Video source device:

1. Take a Component Video to VGA (D-Sub) adaptor cable and connect the end with 3 RCA type connectors to the Component Video output jacks of the Video source device. Match the color of the plugs to the color of the jacks; green to green, blue to blue, and red to red.
2. Connect the other end of the Component Video to VGA (D-Sub) adaptor cable (with a D-Sub type connector) to the **COMPUTER** jack on the projector.

-  • **If the selected video image is not displayed after the projector is turned on and the correct video source has been selected, check that the Video source device is turned on and operating correctly. Also check that the signal cables have been connected correctly.**

Connecting a Composite source device

Examine your Video source device to determine if it has an unused Composite output jack available:

- **If so, you can continue with this procedure.**
- **If not, you will need to reassess which method you can use to connect to the device.**

To connect the projector to a Video source device:

1. Take a Video cable and connect one end to the Video output jack of the Video source device.
2. Connect the other end of the Video cable to the **VIDEO** jack on the projector.

-  • **If the selected video image is not displayed after the projector is turned on and the correct video source has been selected, check that the Video source device is turned on and operating correctly. Also check that the signal cables have been connected correctly.**

Operation

Starting up the projector

1. Plug the power cord into the projector and into a power outlet. Turn on the power outlet switch (where fitted). Check that the **POWER indicator light** on the projector lights orange after power has been applied.

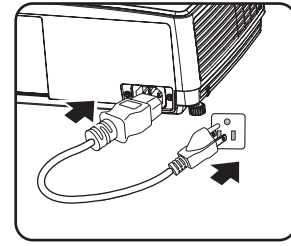

- **Please use the original accessories (e.g. power cable) only with the device to avoid possible dangers such as electric shock and fire.**
- **If Direct Power On function is activated in the **SYSTEM SETUP: Basic > Operation Settings** menu, the projector will turn on automatically after the power cord has been connected and power has been applied. See ["Direct Power On" on page 52](#) for details.**
- **If Signal Power On function is activated in the **SYSTEM SETUP: Basic > Operation Settings** menu, the projector will turn on automatically when **VGA** signal is detected. See ["Signal Power On" on page 52](#) for details.**

2. Press  **POWER** on the projector or remote control to start the projector. The **POWER indicator light** flashes and stays green when the projector is on. The start up procedure takes about 30 seconds. In the later stage of start up, a startup logo is projected. (If necessary) Rotate the focus ring to adjust the image clearness.

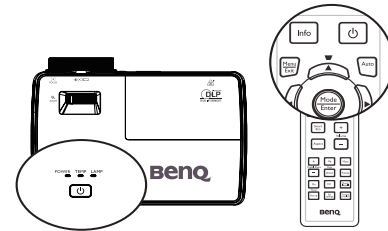

- **If the projector is still hot from previous activity, it will run the cooling fan for approximately 90 seconds before energizing the lamp.**

3. If the projector is activated for the first time, select your OSD language following the on-screen instructions.
4. If you are prompted for a password, press the arrow keys to enter a six digit password. See ["Utilizing the password function" on page 26](#) for details.
5. Switch all of the connected equipment on.
6. The projector will start to search for input signals. The current input signal being scanned displays in the screen. If the projector doesn't detect a valid signal, the message **'No Signal'** will continue displaying until an input signal is found.

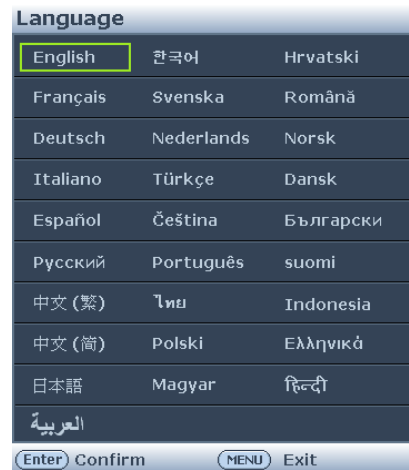

You can also press **Source** on the remote control to select your desired input signal. See ["Switching input signal" on page 29](#) for details.

- ☞ • **If no signal is detected for 3 minutes, the projector automatically enters Eco Blank mode.**

Adjusting the projected image

Adjusting the projection angle

The projector is equipped with 1 elevator adjuster foot and 1 rear adjuster foot. These adjusters change the image height and projection angle. To adjust the projector:

1. Use the elevator adjuster foot to raise/lower the image to the desired height.
2. Use the rear adjuster foot to fine tune the horizontal angle.

To retract the foot, screw the adjuster foot in a reverse direction.

If the projector is not placed on a flat surface or the screen and the projector are not perpendicular to each other, the projected image becomes trapezoidal. To correct this situation, see ["Correcting keystone" on page 24](#) for details.

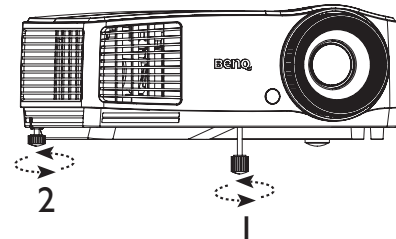

- ⚠ • **Do not look into the lens while the lamp is on. The strong light from the lamp may cause damage to your eyes.**
- **Be careful when you press the adjuster button as it is close to the exhaust vent where hot air comes from.**

Auto-adjusting the image

In some cases, you may need to optimize the picture quality. To do this, press **Auto** on the remote control. Within 3 seconds, the built-in Intelligent Auto Adjustment function will re-adjust the values of Frequency and Clock to provide the best picture quality.

- **The screen will be blank while Auto is functioning.**
- **This function is only available when PC signal (analog RGB) is selected.**

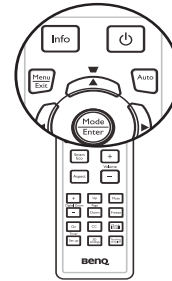

Use build-in test pattern

You can adjust the image shape and focus status by observing the input signal content, or using the test pattern build-in OSD manual from OSD or remote control for better observe the shape changed.

Open the OSD menu and go to the **SYSTEM SETUP: Advanced > Test Pattern > On**. Press **Mode/Enter**. The **Test Pattern** displays.

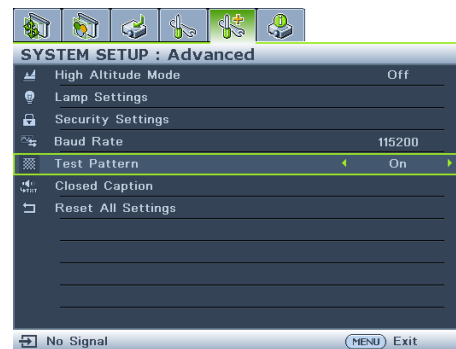
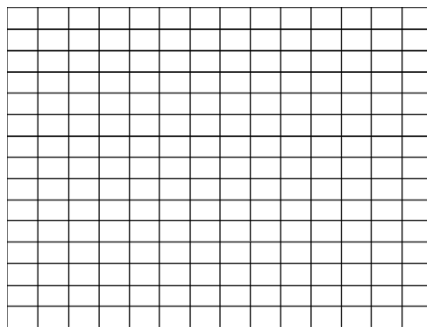
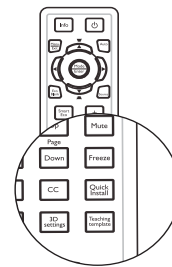

Fine-tuning the image size and clarity

1. Adjust the projected image to the size that you need using the zoom ring.

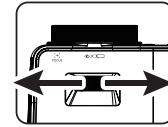
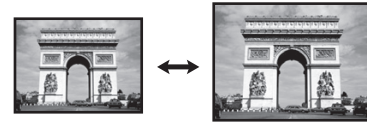

2. Then sharpen the image by rotating the focus ring.



Correcting keystone

Keystoning refers to the situation where the projected image is noticeably wider at either the top or bottom. It occurs when the projector is not perpendicular to the screen.

The projector is equipped with Auto Keystone and Keystone features. Auto Keystone enables to correct any keystoning of the image automatically while Keystone enables to manually correct distorted images resulting from an angled projection.

To correct this, besides adjusting the height of the projector, you will need to manually correct it following one of these steps.

- Using the remote control

Press **▼** / **▲** on the remote control to display the Keystone correction page. Press **▲** to correct keystoning at the top of the image. Press **▼** to correct keystoning at the bottom of the image.

- Using the OSD menu

1. Press **Menu/Exit** and then press **◀** / **▶** until the **DISPLAY** menu is highlighted.
2. Press **▼** to highlight **Auto Keystone** and select **Off**.
3. Press **▼** to highlight **Keystone** and press **Mode/Enter**. The **Keystone** correction page displays.
4. Press **▲** to correct keystoning at the top of the image or press **▼** to correct keystoning at the bottom of the image.



Press **▲** / **▼**.

Press **▼** / **▲**.

Using the menus

The projector is equipped with On-Screen Display (OSD) menus for making various adjustments and settings.

Below is the overview of the OSD menu.

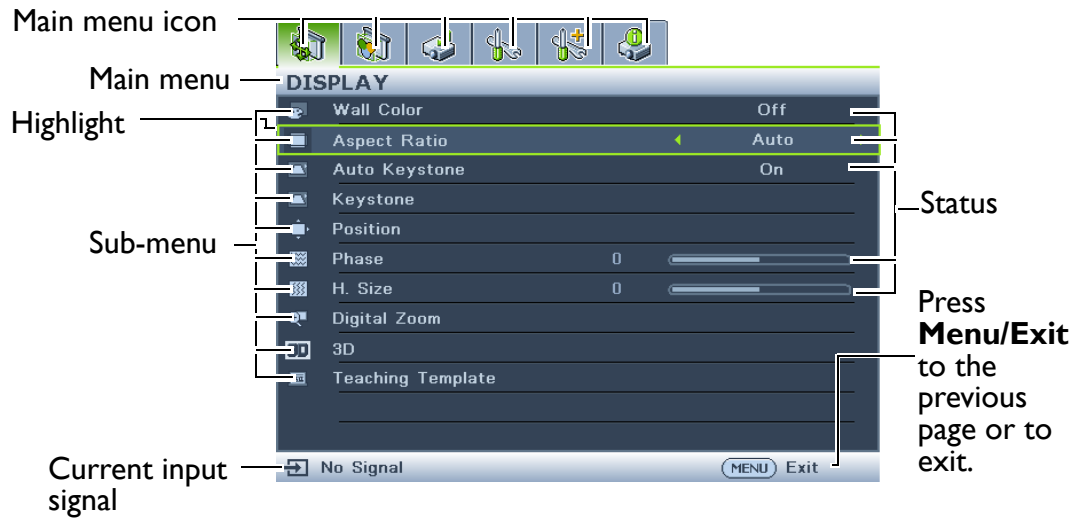

The following example describes how to set the OSD language.

1. Press **Menu/Exit** on the remote control to turn the OSD menu on.



3. Press **▼** to highlight **Background Color** and press **◀/▶** to select a **Background Color**.

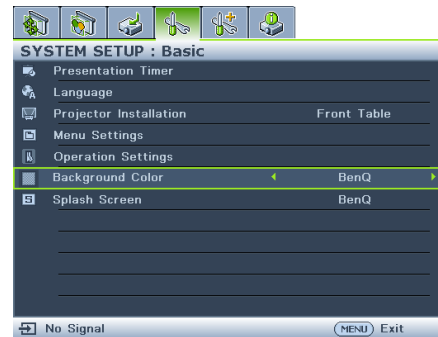

2. Use **◀/▶** to highlight the **SYSTEM SETUP: Basic** menu.



4. Press **Menu/Exit** twice* on the remote control to leave and save the settings.

***The first press leads you back to the main menu and the second press closes the OSD menu.**

Securing the projector

Using a security cable lock

The projector has to be installed in a safe place to prevent theft. Otherwise, purchase a lock, such as the Kensington lock, to secure the projector. You can locate a Kensington lock slot on the rear side of the projector. See item 7 on page 10 for details.

A Kensington security cable lock is usually a combination of key(s) and the lock. Refer to the lock's documentation for finding out how to use it.

Utilizing the password function

For security purposes and to help prevent unauthorized use, the projector includes an option for setting up password security. The password can be set through the On-Screen Display (OSD) menu.

WARNING: You will be inconvenienced if you activate the power-on lock functionality and subsequently forget the password. Print out this manual (if necessary) and write the password you used in this manual, and keep the manual in a safe place for later recall.

Setting a password

Once a password has been set, the projector cannot be used unless the correct password is entered every time the projector is started.

1. Open the OSD menu and go to the **SYSTEM SETUP: Advanced > Security Settings** menu. Press **Mode/Enter**. The **Security Settings** page displays.
2. Highlight **Change Security** and press **Mode/Enter**.
3. As pictured to the right, the four arrow keys (**▲**, **▶**, **▼**, **◀**) respectively represent 4 digits (1, 2, 3, 4). According to the password you desire to set, press the arrow keys to enter six digits for the password.
4. Confirm the new password by re-entering the new password.



Once the password is set, the OSD menu returns to the **Security Settings** page with highlight in the row of **Power On Lock**. Select **On** by pressing **◀/▶**.

IMPORTANT: The digits being input will display as asterisks on-screen. Write your selected password down here in this manual in advance or right after the password is entered so that it is available to you should you ever forget it.

Password: _____

Keep this manual in a safe place.

5. To leave the OSD menu, press **Menu/Exit**.

If you forget the password

If the password function is activated, you will be asked to enter the six-digit password every time you turn on the projector. If you enter the wrong password, the password error message as pictured to the right displays lasting for three seconds, and the message **'INPUT PASSWORD'** follows. You can retry by entering another six-digit password, or if you did not record the password in this manual, and you absolutely do not remember it, you can use the password recall procedure. See ["Entering the password recall procedure" on page 27](#) for details.

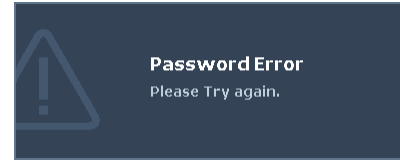

If you enter an incorrect password 5 times in succession, the projector will automatically shut down in a short time.

Entering the password recall procedure

1. Press and hold **Auto** on the remote control for 3 seconds. The projector will display a coded number on the screen.
2. Write down the number and turn off your projector.
3. Seek help from the local BenQ service center to decode the number. You may be required to provide proof of purchase documentation to verify that you are an authorized user of the projector.

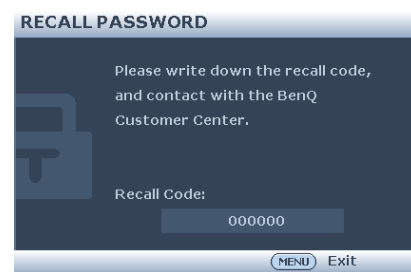

Changing the password

1. Open the OSD menu and go to the **SYSTEM SETUP: Advanced > Security Settings > Change Password** menu.
2. Press **Mode/Enter**. The message **'INPUT CURRENT PASSWORD'** displays.
3. Enter the old password.
 - If the password is correct, another message **'INPUT NEW PASSWORD'** displays.
 - If the password is incorrect, the password error message displays lasting for three seconds, and the message **'INPUT CURRENT PASSWORD'** displays for your retry. You can press **Menu/Exit** to cancel the change or try another password.
4. Enter a new password.



IMPORTANT: The digits being input will display as asterisks on-screen. Write your selected password down here in this manual in advance or right after the password is entered so that it is available to you should you ever forget it.

Password: _____

Keep this manual in a safe place.

5. Confirm the new password by re-entering the new password.

6. You have successfully assigned a new password to the projector. Remember to enter the new password next time the projector is started.
7. To leave the OSD menu, press **Menu/Exit**.

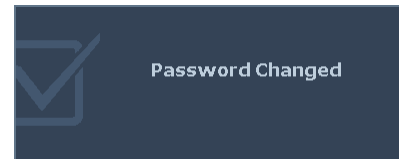

Disabling the password function

To disable password protection, go back to the **SYSTEM SETUP: Advanced > Security Settings > Change Security > Power On Lock** menu after opening the OSD menu system. Select **Off** by pressing **◀/▶**. The message **'INPUT PASSWORD'** displays. Enter the current password.

- If the password is correct, the OSD menu returns to the **Security Settings** page with **'Off'** shown in the row of **Power On Lock**. You will not have to enter the password next time you turn on the projector.
- If the password is incorrect, the password error message displays lasting for three seconds, and the message **'INPUT PASSWORD'** displays for your retry. You can press **Menu/Exit** to cancel the change or try another password.

 **Though the password function is disabled, you need to keep the old password in hand should you ever need to re-activate the password function by entering the old password.**

Switching input signal

The projector can be connected to multiple devices at the same time. However, it can only display one full screen at a time. When starting up, the projector automatically searches for the available signals.

Be sure the **Quick Auto Search** function in the **SOURCE** menu is **On** (which is the default of this projector) if you want the projector to automatically search for the signals.

You can also manually cycle through the available input signals.

1. Press **Source** on the remote control. A source selection bar displays.

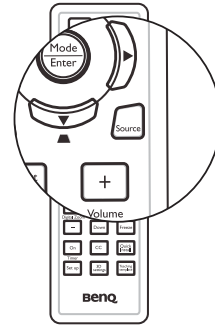

2. Press **▲/▼** until your desired signal is selected and press **Mode/Enter**.

Once detected, the selected source information will display on the screen for seconds. If there is multiple equipment connected to the projector, repeat steps 1-2 to search for another signal.

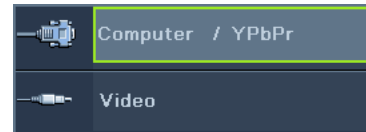

- **The brightness level of the projected image will change accordingly when you switch between different input signals. Data (graphic) "PC" presentations using mostly static images are generally brighter than "Video" using mostly moving images (movies).**
- **The input signal type effects the options available for the Picture Mode. See ["Selecting a picture mode" on page 32](#) for details.**
- **For best display picture results, you should select and use an input signal which outputs at this resolution. Any other resolutions will be scaled by the projector depending upon the 'aspect ratio' setting, which may cause some image distortion or loss of picture clarity. See ["Selecting the aspect ratio" on page 31](#) for details.**

Magnifying and searching for details

If you need to find the details on the projected picture, magnify the picture. Use the direction arrow keys for navigating the picture.

- Using the remote control

1. Press **Digital Zoom +/-** to display the Zoom bar.
2. Press **Digital Zoom +** to magnify the center of the picture. Press the key repeatedly until the picture size is suitable for your need.
3. Use the directional arrows (**▲**, **▼**, **◀**, **▶**) on the remote control to navigate the picture.
4. To restore the picture to its original size, press **Auto**. You can also press **Digital Zoom -**. When the key is pressed again, the picture is further reduced until it is restored to the original size.

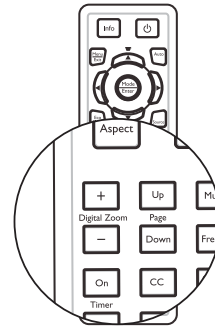

- Using the OSD menu

1. Press **Menu/Exit** and then press **◀ / ▶** until the **DISPLAY** menu is highlighted.
2. Press **▼** to highlight **Digital Zoom** and press **Mode/Enter**. The Zoom bar displays.
3. Repeat steps 2-4 in the section of "[Using the remote control](#)" above.

 **The picture can only be navigated after the picture is magnified. You can further magnify the picture while searching for details.**

Selecting the aspect ratio

The 'aspect ratio' is the ratio of the image width to the image height. Most analog TV and computers are in 4:3 ratio, and digital TV and DVDs are usually in 16:9 or 16:10 ratio.

With the advent of digital signal processing, digital display devices like this projector can dynamically stretch and scale the image output to a different aspect than that of the image input signal.

To change the projected image ratio (no matter what aspect the source is):

- Using the remote control

1. Press **Aspect** to show the current setting.
2. Press **Aspect** repeatedly to select an aspect ratio to suit the format of the video signal and your display requirements.

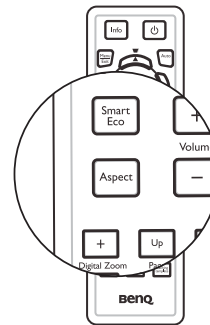

- Using the OSD menu

1. Press **Menu/Exit** and then press ◀/▶ until the **DISPLAY** menu is highlighted.
2. Press ▼ to highlight **Aspect Ratio**.
3. Press ◀/▶ to select an aspect ratio to suit the format of the video signal and your display requirements.

About the aspect ratio

1. **Auto**: Scales an image proportionally to fit the projector's native resolution in its horizontal or vertical width. This is suitable for the incoming image which is neither in 4:3 nor 16:9 and you want to make most use of the screen without altering the image's aspect ratio.
2. **Real**: The image is projected as its original resolution, and resized to fit within the display area. For input signals with lower resolutions, the projected image will display smaller than if resized to full screen. You could adjust the zoom setting or move the projector towards the screen to increase the image size if necessary. You may also need to refocus the projector after making these adjustments.
3. **4:3**: Scales an image so that it is displayed in the center of the screen with a 4:3 aspect ratio. This is most suitable for 4:3 images like computer monitors, standard definition TV and 4:3 aspect DVD movies, as it displays them without aspect alteration.
4. **16:9**: Scales an image so that it is displayed in the center of the screen with a 16:9 aspect ratio. This is most suitable for images which are already in a 16:9 aspect, like high definition TV, as it displays them without aspect alteration.
5. **16:10**: Scales an image so that it is displayed in the center of the screen with a 16:10 aspect ratio. This is most suitable for images which are already in a 16:10 aspect, like high definition TV, as it displays them without aspect alteration.

Optimizing the image

Selecting a picture mode

The projector is preset with several predefined picture modes so that you can choose one to suit your operating environment and input signal picture type.

To select an operation mode that suits your need, you can follow one of the following steps.

- Press **Mode/Enter** on the remote control repeatedly until your desired mode is selected.
- Go to the **PICTURE > Picture Mode** menu and press ◀/▶ to select a desired mode.



The picture modes are listed below.

1. **Dynamic mode:** Maximizes the brightness of the projected image. This mode is suitable for environments where extra-high brightness is required, such as using the projector in well lit rooms.
2. **Presentation mode (Default):** Is designed for presentations. The brightness is emphasized in this mode.
3. **sRGB mode:** Maximizes the purity of RGB colors to provide true-to-life images regardless of brightness setting. It is most suitable for viewing photos taken with an sRGB compatible and properly calibrated camera, and for viewing PC graphic and drawing applications such as AutoCAD.
4. **Cinema mode:** Is appropriate for playing colorful movies, video clips from digital cameras or DVs through the PC input for best viewing in a blackened (little light) environment.
5. **User 1/User 2 mode:** Recalls the settings customized based on the current available picture modes. See "[Setting the User 1/User 2 mode](#)" on page 32 for details.

Setting the User 1/User 2 mode

There are two user-definable modes if the current available picture modes are not suitable for your need. You can use one of the picture modes (except the **User 1/ User 2**) as a starting point and customize the settings.

1. Press **Menu/Exit** to open the On-Screen Display (OSD) menu.
2. Go to the **PICTURE > Picture Mode** menu.
3. Press ◀/▶ to select **User 1** to **User 2**.
4. Press ▼ to highlight **Reference Mode**.

 **This function is only available when User 1 or User 2 mode is selected up in the Picture Mode sub-menu item.**

5. Press ◀/▶ to select a picture mode that is closest to your need.
6. Press ▼ to select a sub-menu item to be changed and adjust the value with ◀/▶. See "[Fine-tuning the image quality in user modes](#)" below for details.

7. When all settings have been done, highlight **Save Settings** and press **Mode/Enter** to store the settings.
8. The confirmation message '**Setting Saved**' displays.

Using Wall Color

In the situation where you are projecting onto a colored surface such as a painted wall which may not be white, the **Wall Color** feature can help correct the projected picture's color to prevent possible color difference between the source and projected pictures.

To use this function, go to the **DISPLAY > Wall Color** menu and press **◀/▶** to select a color which is the closest to the color of the projection surface. There are several precalibrated colors to choose from: Light Yellow, Pink, Light Green, Blue, and Blackboard.

Fine-tuning the image quality in user modes

According to the detected signal type and selected picture mode, some of the below functions may not be available. Based on your needs, you can make adjustments to these functions by highlighting them and pressing **◀/▶** on the remote control.

Adjusting Brightness

The higher the value, the brighter the image. And the lower the setting, the darker the image. Adjust this control so the black areas of the image appear just as black and that detail in the dark areas is visible.



Adjusting Contrast

The higher the value, the greater the contrast. Use this to set the peak white level after you have previously adjusted the **Brightness** setting to suit your selected input and viewing environment.



Adjusting Color

Lower setting produces less saturated colors. If the setting is too high, colors on the image will be overpowering, which makes the image unrealistic.

Adjusting Tint

The higher the value, the more reddish the picture becomes. The lower the value, the more greenish the picture becomes.

Adjusting Sharpness

The higher the value, the sharper the picture becomes. The lower the value, the softer the picture becomes.

Adjusting Brilliant Color

This feature utilizes a new color-processing algorithm and system level enhancements to enable higher brightness while providing truer, more vibrant colors in picture. It enables a greater than 50% brightness increase in mid-tone images, which are common in video and natural scenes, so the projector reproduces images in realistic and true colors. If you prefer images with that quality, select **On**. If you don't need it, select **Off**.

When **Off** is selected, the **Color Temperature** function is not available.

Selecting a Color Temperature

The options available for color temperature* settings vary according to the signal type selected.

1. **Cool:** Makes images appear bluish white.
2. **Normal:** Maintains normal colorings for white.
3. **Warm:** Makes images appear reddish white.

*About color temperatures:

There are many different shades that are considered to be "white" for various purposes. One of the common methods of representing white color is known as the "color temperature". A white color with a low color temperature appears to be reddish white. A white color with a high color temperature appears to have more blue in it.

Setting a preferred color temperature

To set a preferred color temperature:

1. Highlight **Color Temperature** and select Warm, **Normal** or Cool by pressing ◀/ ▶ on the remote control.
2. Press ▼ to highlight **Color Temperature Fine Tuning** and press **Mode/Enter**. The **Color Temperature Fine Tuning** page displays.
3. Press ▲/▼ to highlight the item you want to change and adjust the values by pressing ◀/ ▶ .
 - R Gain/G Gain/B Gain: Adjusts the contrast levels of Red, Green, and Blue.
 - R Offset/G Offset/B Offset: Adjusts the brightness levels of Red, Green, and Blue.
4. Press **Menu/Exit** to exit and save the settings

3D Color Management

In most installation situations, color management will not be necessary, such as in classroom, meeting room, or lounge room situations where lights remain on, or where building external windows allow daylight into the room.

Only in permanent installations with controlled lighting levels such as boardrooms, lecture theaters, or home theaters, should color management be considered. Color management provides fine color control adjustment to allow for more accurate color reproduction, should you require it.

Proper color management can only be achieved under controlled and reproducible viewing conditions. You will need to use a colorimeter (color light meter), and provide a set of suitable source images to measure color reproduction. These tools are not provided with the projector, however, your projector supplier should be able to provide you with suitable guidance, or even an experienced professional installer.

The Color Management provides six sets (RGBCMY) of colors to be adjusted. When you select each color, you can independently adjust its range and saturation according to your preference.

If you have purchased a test disc which contains various color test patterns and can be used to test the color presentation on monitors, TVs, projectors, etc. You can project any image from the disc on the screen and enter the **3D Color Management** menu to make adjustments.

To adjust the settings:

1. Go to the **PICTURE** menu and highlight **3D Color Management**.

2. Press **Mode/Enter** and the **3D Color Management** page displays.
3. Highlight **Primary Color** and press ◀/▶ to select a color from among Red, Yellow, Green, Cyan, Blue, or Magenta.
4. Press ▼ to highlight **Hue** and press ◀/▶ to select its range. Increase in the range will include colors consisted of more proportions of its two adjacent colors.

Please refer to the illustration to the right for how the colors relate to each other.

For example, if you select Red and set its range at 0, only pure red in the projected picture will be selected. Increasing its range will include red close to yellow and red close to magenta.

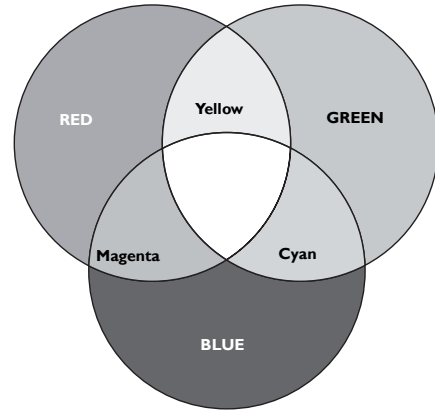

5. Press ▼ to highlight **Saturation** and adjust its values to your preference by pressing ◀/▶. Every adjustment made will reflect to the image immediately.
For example, if you select Red and set its value at 0, only the saturation of pure red will be affected.



Saturation is the amount of that color in a video picture. Lower settings produce less saturated colors; a setting of “0” removes that color from the image entirely. If the saturation is too high, that color will be overpowering and unrealistic.

6. Press ▼ to highlight **Gain** and adjust its values to your preference by pressing ◀/▶. The contrast level of the primary color you select will be affected. Every adjustment made will reflect to the image immediately.
7. Repeat steps 3 to 6 for other color adjustments.
8. Make sure you have made all of the desired adjustments.
9. Press **Menu/Exit** to exit and save the settings.

Resetting current or all picture modes

1. Go to the **PICTURE** menu and highlight **Reset Picture Settings**.
2. Press **Mode/Enter** and press ▲/▼ to select **Current** or **All**.
 - **Current:** returns current picture mode to the factory preset settings.
 - **All:** returns all settings, except **User 1/User 2** in the **PICTURE** menu to the factory preset settings.

Setting the presentation timer

The presentation timer can indicate the presentation time on the screen to help you achieve better time management when giving presentations. Follow these steps to utilize this function:

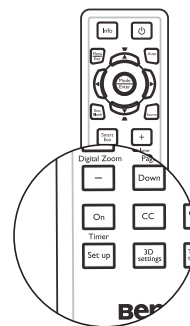

1. Press **Timer Set up** on the remote control or go to the **SYSTEM SETUP: Basic > Presentation Timer** menu and press **Mode/Enter** to display the **Presentation Timer** page.
2. Highlight **Timer Period** and decide the timer period by pressing **◀/▶**. The length of time can be set from 1 to 5 minutes in 1-minute increments and 5 to 240 minutes in 5-minute increments.
3. Press **▼** to highlight **Timer Display** and choose if you want the timer to show up on the screen by pressing **◀/▶**.

Selection	Description
Always	Displays the timer on screen throughout the presentation time.
3 min/2 min/1 min	Displays the timer on screen in the last 3/2/1 minute(s).
Never	Hides the timer throughout the presentation time.

4. Press **▼** to highlight **Timer Position** and set the timer position by pressing **◀/▶**.
Top-Left → Bottom-Left → Top-Right → Bottom-Right
5. Press **▼** to highlight **Timer Counting Direction** and select your desired counting direction by pressing **◀/▶**.

Selection	Description
Count Up	Increases from 0 to the preset time.
Count Down	Decrease from the preset time to 0.

6. To activate the presentation timer, press **▼** and press **◀/▶** to select **On** and press **Mode/Enter**.
7. A confirmation message displays. Highlight **Yes** and press **Mode/Enter** to confirm.

To cancel the timer, perform the following steps.

- Using the remote control.

Press **Timer On** and press ◀/▶ to highlight **Off** and press **Mode/Enter**.

- Using the OSD menu.

1. Go to the **SYSTEM SETUP: Basic > Presentation Timer** menu and highlight **Off**. Press **Mode/Enter**. A confirmation message displays.
2. Highlight **Yes** and press **Mode/Enter** to confirm.

How to use the Timer On key?

Timer On is a multi-functional key.

- If the presentation timer is off, pressing this key displays a confirmation message. You can decide whether to activate the timer or not by following the on-screen instruction.
- If the timer is already on, pressing this key displays a confirmation message. You can decide whether to restart, continue or turn off the timer by following the on-screen instruction.

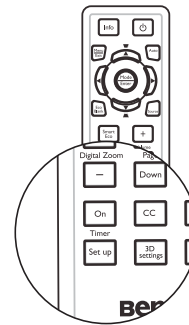

Remote paging operations

Connect the projector to your PC or notebook with a USB cable prior to using the paging function.

You can operate your display software program (on a connected PC) which responds to page up/down commands (like Microsoft PowerPoint) by pressing **Page Up/Down** on the remote control.

If remote paging function doesn't work, check if the USB connection is correctly made and the mouse driver on your computer is updated to the latest version.

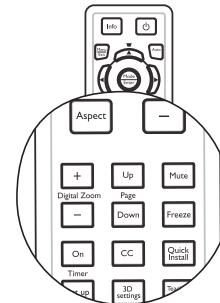

Hiding the image

Press the **Eco Blank** button from projector or remote control to turn off the image for a period of time with up to 70% lamp power saving. Press any key on the remote control to restore the image.

The word "**Eco Blank**" appears at the screen while the image is hidden. When this function is activated with an audio input connected, the audio can still be heard.

- Eco Blank: Save up 70% of your lamp power. Time to do your part in saving the planet.

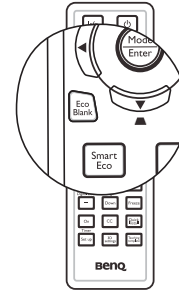

The automatic switch to **Eco Blank Mode** after the projector is turned on for over three minutes without a display source, eliminating unnecessary energy waste and prolonging the life of the projector lamp

You can set the blank time in the **SYSTEM SETUP: Basic > Operation Settings > Blank Timer** menu to let the projector return the image automatically after a period of time when there is no action taken on the blank screen. The length of time can be set from 5 to 30 minutes in 5-minute increments.

 **Do not block the projection lens from projecting as this could cause the blocking object to become heated.**

No matter Eco Blank Timer is activated or not, you can press any key (except the Page Up/Down key) on the remote control to restore the picture.

Freezing the image

Press  on the remote control to freeze the image. The word '**FREEZE**' will display in the screen. To release the function, press any key (except the **Page Up/Down** key) on the remote control.

Even if an image is frozen on the screen, the pictures are running on the video or other device. If the connected devices have active audio output, you will still hear the audio even though the image is frozen on screen.

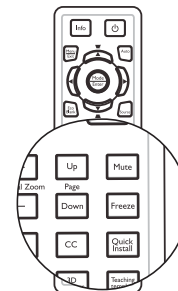

Operating in a high altitude environment

We recommend you use the **High Altitude Mode** when your environment is 1500 m –3000 m above sea level, and ambient temperature is between 0°C–35°C.

 **Do not use the High Altitude Mode if your altitude is between 0 m and 1500 m and ambient temperature is between 0°C and 35°C. The projector will be over cooled, if you turn the mode on under such a condition.**

To activate the **High Altitude Mode**:

1. Press **Menu/Exit** and then press ◀ / ▶ until the **SYSTEM SETUP: Advanced** menu is highlighted.
2. Press ▼ to highlight **High Altitude Mode** and press ◀ / ▶ to select **On**. A confirmation message displays.
3. Highlight **Yes** and press **Mode/Enter**.

Operation under "**High Altitude Mode**" may cause a higher decibel operating noise level because of increased fan speed necessary to improve overall system cooling and performance.

If you use this projector under other extreme conditions excluding the above, it may display auto shut-down symptoms, which is designed to protect your projector from over-heating. In cases like this, you should switch to High Altitude mode to solve these symptoms. However, this is not to state that this projector can operate under any and all harsh or extreme conditions.

Use Teaching Template

Making writing on the board easier for teachers, you can use build-in template by OSD or remote control.

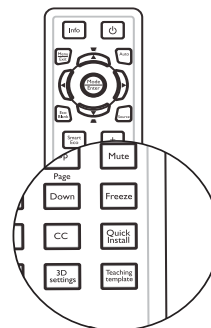

Open the OSD menu and go to the **DISPLAY > Teaching Template** . Choice **Blackboard/Whiteboard > Off/Letter Formation/Worksheet/Coordinate Chart**. The Teaching Template displays.

Teaching Template	Whiteboard	Blackboard
Letter Formation		
Worksheet		
Coordinate Chart		

Personalizing the projector menu display

The On-Screen Display (OSD) menus can be set according to your preferences. The following settings do not affect the projection settings, operation, or performance.

- **Menu Display Time** in the **SYSTEM SETUP: Basic > Menu Settings** menu sets the length of time the OSD will remain active after your last key press. Use ◀/▶ to select a suitable time frame.
- **Menu Position** in the **SYSTEM SETUP: Basic > Menu Settings** menu sets the OSD position in five locations. Use ◀/▶ to select a preferred position.
- **Language** in the **SYSTEM SETUP: Basic** menu sets your familiar language for the OSD menus. Use **Enter** to select your language.
- **Reminder Message** in the **SYSTEM SETUP: Basic > Menu Settings** menu sets whether to display reminder messages on screen. Use ◀/▶ to select your desired setting.
- **Splash Screen** in the **SYSTEM SETUP: Basic** menu sets a preferred logo screen to be displayed during projector start-up. Use ◀/▶ to select a screen.

Select the lamp saver mode

- Using the remote control.

Press **SmartEco** and highlight **Lamp Mode** and press ◀/▶ to select **Normal/Economic/SmartEco**.

- Using the OSD menu.

1. Press **Menu/Exit** and then press ◀/▶ until the **SYSTEM SETUP: Advanced** menu is highlighted.
2. Press ▼ to highlight **Lamp Mode** and press **Mode/Enter**. The Lamp Settings page displays.
3. Highlight **Lamp Mode** and press ◀/▶ to select **Normal/Economic/SmartEco**. The lamp brightness vary from the different lamp mode, see the description list in table below.

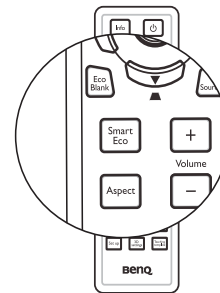

Lamp Mode	Description
Normal	Provides full lamp brightness
Economic	Lowers brightness to extend the lamp life and decreases the fan noise
SmartEco	Adjusts the lamp power automatically depending on the content brightness level

☞ **If the Economic mode or SmartEco mode is selected, the light output will be reduced and result in darker projected pictures.**

Shutting down the projector

1. Press **POWER** and a confirmation message displays prompting you. If you don't respond in a few seconds, the message will disappear.
2. Press **POWER** a second time. The **POWER indicator light** flashes orange, the projection lamp shuts down, and the fans will continue to run for approximately 90 seconds to cool down the projector.



- **To protect the lamp, the projector will not respond to any commands during the cooling process.**

- **To shorten the cooling time, you can also activate the Quick Cooling function. See "Quick Cooling" on page 52 for details.**

3. Once the cooling process finishes, the **POWER indicator light** is a steady orange and fans stop.
4. Disconnect the power cord from the power outlet if the projector will not be used in an extended period of time.
5. When **Instant Restart** is **On**, users can restart projector immediately within 90 secs after turning off projector. (Projector will maintain 30% of power during the 90 secs)

When **Instant Restart** is **Off**, users need to wait lamp to cool down to restart the projector. When instant restart is on, quick cooling item will be grey out



- **If the projector is not properly shut down, to protect the lamp, when you attempt to re-start the projector, the fans will run for a few minutes to cool down. Press Power again to start the projector after the fans stop and the POWER indicator light turns orange.**

- **Actual lamp life may vary due to different environmental conditions and usage.**

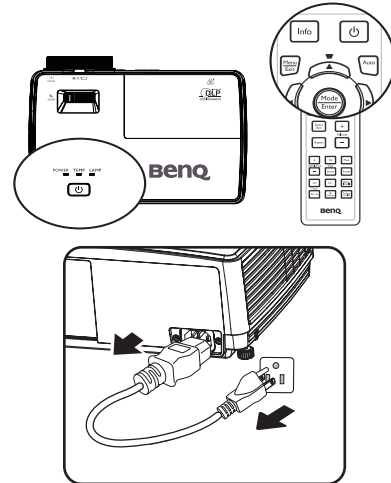

Menu operation

Menu system

Please note that the on-screen display (OSD) menus vary according to the signal type selected.

Main menu	Sub-menu	Options	
I. DISPLAY	Wall Color	Off/Light Yellow/Pink/Light Green/Blue/Blackboard	
	Aspect Ratio	Auto/Real/4:3/16:9/16:10	
	Auto Keystone	On/Off	
	Keystone		
	Position		
	Phase		
	H. Size		
	Digital Zoom		
	3D	3D Mode	Top Bottom/Frame Sequential/Side by Side/Off
		3D Sync Invert	Disable/Invert
		Save 3D Settings	3D Settings 1/3D Settings 2/3D Settings 3
		Apply 3D Settings	3D Settings 1/3D Settings 2/3D Settings 3/Off
	Teaching Template	Blackboard	Off/Letter Formation/Worksheet/Coordinate Chart
		Whiteboard	Off/Letter Formation/Worksheet/Coordinate Chart

2. PICTURE	Picture Mode	Dynamic/Presentation/sRGB/Cinema/(3D)/User 1/User 2	
	Reference Mode	Dynamic/Presentation/sRGB/Cinema/(3D)	
	Brightness		
	Contrast		
	Color		
	Tint		
	Sharpness		
	Color Temperature	Cool/Normal/Warm	
	Color Temperature Fine Tuning	R Gain/G Gain/B Gain/R Offset/G Offset/B Offset	
	3D Color Management	Primary Color	R/G/B/C/M/Y
		Hue	
Saturation			
3. SOURCE	Gain		
	Reset Picture Settings	Current/All/Cancel	
	Quick Auto Search	On/Off	
	Color Space Conversion	Auto/RGB/YUV	

4. SYSTEM SETUP: Basic	Presentation Timer	Timer Period	1~240 minutes	
		Timer Display	Always /3 min/2 min/1 min/ Never	
		Timer Position	Top-Left /Bottom-Left/Top- Right/Bottom-Right	
		Timer Counting Direction	Count Down /Count Up	
		Sound Reminder	On/ Off	
		On/Off	Yes /No	
	Language	English / Français / Deutsch Italiano / Español / Русский 繁體中文 / 简体中文 / 日本語 / 한국어 / Svenska / Nederlands / Türkçe / Čeština / Português / ਪੰਜਾਬੀ / Polski Magyar / Български / Hrvatski / Română / Suomi / Norsk / Dansk / Indonesian / Ελληνικά / العربية / हिन्दी		
	Projector Installation	Front Table /Rear Table/Rear Ceiling/Front Ceiling		
	Menu Settings	Menu Display Time	5 sec/10 sec/ 20 sec /30 sec/ Always	
		Menu Position	Center /Top-Left/Top-Right/ Bottom-Right/Bottom-Left	
		Reminder Message	On/ Off	
	Operation Settings	Direct Power On	On/ Off	
		Signal Power On	On/ Off	
		Auto Power Off	Disable/3 min/10 min/15 min/ 20 min /25 min/30 min	
		Quick Cooling	On/ Off	
		Instant Restart	On/ Off	
		Blank Timer	Disable /5 min/10 min/15 min/20 min/25 min/30 min	
		Sleep Timer	Disable /30 min/1 hr/2 hr/3 hr/4 hr/8 hr/12 hr	
	Background Color	BenQ /Black/Blue/Purple		
	Splash Screen	BenQ /Black/Blue		

5. SYSTEM SETUP: Advanced	High Altitude Mode	On/Off	Yes/No	
	Lamp Settings	Lamp Mode	Normal/Economic/ SmartEco	
		Lamp Spa Mode	On/Off	
		Reset lamp timer	Reset/ Cancel	
		Equivalent lamp hour		
	Security Settings	Change Password		
		Change Security	Power On Lock	
	Baud Rate	2400/4800/9600/14400/19200/ 38400/57600/115200		
	Test Pattern	On/Off		
Closed Caption	Closed Caption Enable	On/Off		
	Caption Version	CC1/CC2/CC3/CC4		
Reset All Settings	Reset/ Cancel			
6. INFORMATION	Current System Status	<ul style="list-style-type: none"> • Source • Picture Mode • Resolution • Lamp Mode • 3D Format • Color System • Equivalent Lamp • Firmware Version 		



Note that the menu items are available when the projector detects at least one valid signal. If there is no equipment connected to the projector or no signal detected, limited menu items are accessible.

Description of each menu

- ☞ • The default values listed in this manual, especially on pages [47-55](#), are for reference only. They may vary between the projectors due to the continuous improvement to the products.

FUNCTION	DESCRIPTION	
I. DISPLAY menu	Wall Color	Corrects the projected picture's color when the projection surface is not white. See "Using Wall Color" on page 33 for details.
	Aspect Ratio	There are four options to set the image's aspect ratio depending on your input signal source. See "Selecting the aspect ratio" on page 31 for details.
	Auto Keystone	Corrects any keystone of the image automatically.
	Keystone	Corrects any keystone of the image. See "Correcting keystone" on page 24 for details.
	Position	Displays the position adjustment page. To move the projected image, use the directional arrow keys. The values shown on the lower position of the page change with every key press you made until they reach their maximum or minimum. ☞ This function is only available when a PC signal (analog RGB) is selected.
	Phase	Adjusts the clock phase to reduce image distortion. ☞ This function is only available when a PC signal (analog RGB) is selected. 
	H. Size	Adjusts the horizontal width of the image. ☞ This function is only available when a PC signal (analog RGB) is selected.
	Digital Zoom	Magnifies or reduces the projected image. See "Magnifying and searching for details" on page 30 for details.

FUNCTION	DESCRIPTION
<p style="writing-mode: vertical-rl; transform: rotate(180deg);">I. DISPLAY menu</p> <p>3D</p>	<p>This projector features a 3D function which enables you to enjoy the 3D movies, videos, and sporting events in a more realistic way by presenting the depth of the images. You need to wear a pair of 3D glasses to view the 3D images.</p> <p>3D Mode The default setting is Off. If the projector cannot recognize the 3D format, press ◀ / ▶ to choose a 3D Mode.</p> <p>3D Sync Invert When you discover the inversion of the image depth, enable this function to correct the problem.</p> <p>Apply 3D Settings The projector will apply saved 3D settings and keep these settings when you reboot the projector next time.</p> <p>Save 3D Settings The projector will memorize the current 3D settings.</p>
<p>Teaching Template</p>	<p>Provides some templates as teaching aids. Teachers can use them for teaching. See "Use Teaching Template" on page 40 for details.</p>

	FUNCTION	DESCRIPTION
2. PICTURE menu	Picture Mode	Pre-defined picture modes are provided so you can optimize your projector image set-up to suit your program type. See "Selecting a picture mode" on page 32 for details.
	Reference Mode	Selects a picture mode that best suits your need for the image quality and further fine-tune the image based on the selections listed on the same page below. See "Setting the User 1/User 2 mode" on page 32 for details.
	Brightness	Adjusts the brightness of the image. See "Adjusting Brightness" on page 33 for details.
	Contrast	Adjusts the degree of difference between dark and light in the image. See "Adjusting Contrast" on page 33 for details.
	Color	Adjusts the color saturation level -- the amount of each color in a video image. See "Adjusting Color" on page 33 for details.  This function is only available when a Video signal is selected.
	Tint	Adjusts the red and green color tones of the image. See "Adjusting Tint" on page 33 for details.  This function is only available when a Video signal is selected and the system format is NTSC.
	Sharpness	Adjusts the image to make it look sharper or softer. See "Adjusting Sharpness" on page 33 for details.  This function is only available when a Video signal is selected.

	FUNCTION	DESCRIPTION
2. PICTURE menu	Brilliant Color	See "Adjusting Brilliant Color" on page 33 for details.
	Color Temperature	See "Selecting a Color Temperature" on page 34 for details.
	Color Temperature Fine Tuning	See "Setting a preferred color temperature" on page 34 for details.
	3D Color Management	See "3D Color Management" on page 34 for details.
	Reset Picture Setting	See "Resetting current or all picture modes" on page 35 for details. When Picture Mode is under Dynamic, choosing "Current" will only reset the Dynamic to default value, however, choosing "All" will reset all the Picture Mode settings to default values.
3. SOURCE menu	Quick Auto Search	See "Switching input signal" on page 29 for details.
	Color Space Conversion	See "Magnifying and searching for details" on page 30 for details.

	FUNCTION	DESCRIPTION
4. SYSTEM SETUP: Basic menu	Presentation Timer	Reminds the presenter to finish the presentation within a certain time frame. See "Setting the presentation timer" on page 36 for details.
	Language	Sets the language for the On-Screen Display (OSD) menus. See "Using the menus" on page 25 for details.
	Projector Installation	The projector can be installed on a ceiling or behind a screen, or with one or more mirrors. See "Choosing a location" on page 16 for details.
	Menu Settings	<p>Menu Display Time Sets the length of time the OSD will remain active after your last key press. The range is from 5 to 30 seconds in 5-second increments.</p> <p>Menu Position Sets the On-Screen Display (OSD) menu position.</p> <p>Reminder Message Sets whether to display the reminder message.</p>

FUNCTION	DESCRIPTION
<p style="writing-mode: vertical-rl; transform: rotate(180deg);">4. SYSTEM SETUP: Basic menu</p> <p>Operation Settings</p>	<p>Direct Power On Selecting On enables the function. See "Starting up the projector" on page 21 for details.</p> <p>Signal Power On Selecting On the projector will turn on automatically when VGA signal is detected. Selecting Off the projector has to be turned on manually (by keypad or remote). See "Starting up the projector" on page 21 for details.</p> <p>Auto Power Off Allows the projector to turn off automatically if no input signal is detected after a set period of time. See "Setting Auto Power Off" on page 58 for details.</p> <p>Quick Cooling Selecting On enables the function and the projector cooling time will be shortened to a few seconds.</p> <p> If you attempt to restart the projector right after the quick cooling process, it may not be turned on successfully and will rerun its cooling fans.</p> <p>Instant Restart When instant restart is on, users can restart projector immediately within 90 secs after turning off projector.</p> <p>Blank Timer Sets the image blank time when the Blank feature is activated, once elapsed the image will return to the screen. See "Hiding the image" on page 38 for details.</p> <p>Sleep Timer Sets the auto-shutdown timer. The timer can be set to a value between 30 minutes and 12 hours.</p>
<p>Background Color</p>	<p>Allows you to select which background color will display when no signal is input into the projector. Four options are available: BenQ logo, Black, Blue, or Purple.</p>
<p>Splash Screen</p>	<p>Allows you to select which logo screen will display during projector start-up. Three options are available: BenQ logo, Black screen, or Blue screen.</p>

FUNCTION	DESCRIPTION
High Altitude Mode	A mode for operation in high altitude areas. See "Operating in a high altitude environment" on page 39 for details.
Lamp Settings	<p>Lamp Mode See "Setting Lamp Mode" on page 57 for details.</p> <p>Lamp Spa Mode Keeps the lamp voltage at a lower level over the first few hundred hours of lifetime and keep the maintenance at a high level over a longer period of time. Selecting On activates Lamp Spa Mode after turning off the projector.</p> <p>Reset lamp timer See "Resetting the lamp timer" on page 62 for details.</p> <p>Equivalent lamp hour See "Getting to know the lamp hour" on page 57 for details on how the total lamp hour is calculated.</p>
Security Settings	<p>Change Password You will be asked to enter the current password before changing to a new one.</p> <p>Change Security</p> <p>Power On Lock See "Utilizing the password function" on page 26 for details.</p>
Baud Rate	Selects a baud rate that is identical with your computer's so that you can connect the projector using a suitable RS-232 cable and update or download the projector's firmware. This function is intended for qualified service personnel.
Test Pattern	Selecting On enables the function and the projector displays the grid test pattern. It helps you adjust the image size and focus and check that the projected image is free from distortion. See "Use build-in test pattern" on page 23 for details.

FUNCTION	DESCRIPTION
5. SYSTEM SETUP: Advanced menu Closed Caption	<p>Closed Caption Enable Activates the function by selecting On when the selected input signal carries closed captions.</p> <ul style="list-style-type: none"> • Captions: An on-screen display of the dialogue, narration, and sound effects of TV programs and videos that are closed captioned (usually marked as "CC" in TV listings). <p>Caption Version Selects a preferred closed captioning mode. To view captions, select CC1, CC2, CC3, or CC4 (CC1 displays captions in the primary language in your area).</p>
Reset All Settings	<p>Returns all settings to the factory preset values.</p> <p> The following settings will still remain: User 1, User 2, Projector Installation, High Altitude Mode, Security Settings and Baud Rate.</p>

FUNCTION	DESCRIPTION
6. INFORMATION menu Current System Status	Source Shows the current signal source. Picture Mode Shows the selected mode in the PICTURE menu. Resolution Shows the native resolution of the input signal. Lamp Mode Shows the current lamp mode. 3D Format Shows the current 3D mode. Color System Shows input system format, NTSC, PAL, SECAM, or RGB. Equivalent Lamp Displays the number of hours the lamp has been used. Firmware Version Shows firmware version.

Maintenance

Care of the projector

Your projector needs little maintenance. The only thing you need to do on a regular basis is to keep the lens and case clean.

Never remove any parts of the projector except the lamp. Contact your dealer if other parts need replacing.

Cleaning the lens

Clean the lens whenever you notice dirt or dust on the surface.

- Use a canister of compressed air to remove dust.
- If there is dirt or smears, use lens-cleaning paper or moisten a soft cloth with lens cleaner and gently wipe the lens surface.
- Never use any type of abrasive pad, alkaline/acid cleaner, scouring powder, or volatile solvent, such as alcohol, benzene, thinner or insecticide. Using such materials or maintaining prolonged contact with rubber or vinyl materials may result in damage to the projector surface and cabinet material.

 **Never rub the lens with abrasive materials.**

Cleaning the projector case

Before you clean the case, turn the projector off using the proper shutdown procedure as described in "[Shutting down the projector](#)" on page 42 and unplug the power cord.

- To remove dirt or dust, wipe the case with a soft, lint-free cloth.
- To remove stubborn dirt or stains, moisten a soft cloth with water and a neutral pH detergent. Then wipe the case.

 **Never use wax, alcohol, benzene, thinner or other chemical detergents. These can damage the case.**

Storing the projector

If you need to store the projector for an extended time, please follow the instructions below:

- Make sure the temperature and humidity of the storage area are within the recommended range for the projector. Please refer to "[Specifications](#)" on page 65 or consult your dealer about the range.
- Retract the adjuster feet.
- Remove the battery from the remote control.
- Pack the projector in its original packing or equivalent.

Transporting the projector

It is recommended that you ship the projector with its original packing or equivalent.

Lamp information

Getting to know the lamp hour

When the projector is in operation, the duration (in hours) of lamp usage is automatically calculated by the built-in timer. The method of calculating the equivalent lamp hour is as follows:

Total (equivalent) lamp hour = 2.00 (hours used in Normal mode) + 1.67 (hours used in Eco mode) + 1.00 (hours used in SmartEco mode)

 See "**Setting Lamp Mode**" below for details.

The lamp hour in **Economic/SmartEco** is calculated shorter of that in Normal mode. That is, using the projector in **Economic/SmartEco** mode helps to extend the lamp hour.

To obtain the lamp hour information:

1. Press **Menu/Exit** and then press **◀/▶** until the **SYSTEM SETUP: Advanced** menu is highlighted.
2. Press **▼** to highlight **Lamp Settings** and press **Mode/Enter**. The **Lamp Settings** page displays.
3. You will see the **Equivalent lamp hour** information displaying on the menu.
4. To leave the menu, press **Menu/Exit**.

You can also get the lamp hour information on the **INFORMATION** menu.

Extending lamp life

The projection lamp is a consumable item. To keep the lamp life as long as possible, you can do the following settings via the OSD menu or remote control.

Setting Lamp Mode

Using **Economic/SmartEco** mode will reduce system noise and power consumption. If the **Economic/SmartEco** mode is selected, the light output will be reduced and result in darker projected pictures, the projector protected for longer working life.

Setting the projector in **Economic/SmartEco** mode also extends the lamp operation life. To set **Economic/SmartEco** mode, go into the **SYSTEM SETUP: Advanced > Lamp Settings > Lamp Mode** menu and press **◀/▶** . .

The lamp modes are defined as the chart below.

Lamp Mode	Description
Normal	Provides full lamp brightness
Economic	Lowers brightness to extend the lamp life and decreases the fan noise
SmartEco	Adjusts the lamp power automatically depending on the content brightness level

Setting Auto Power Off

This function allows the projector to turn off automatically if no input source is detected after a set period of time to prevent unnecessary waste of lamp life.

To set **Auto Power Off**, go into the **SYSTEM SETUP: Basic > Auto Power Off** menu and press ◀/▶. The time period can be set from 5 to 30 minutes in 5-minute increments. If the preset time lengths are not suitable for your presentation, select **Disable**. The projector will not automatically shut down in a certain time period.

Activate Lamp Spa Mode

After long time use of lamp, the lamp electrode will be deformed gradually so as to impact the lamp life due to the thermal expansion effect. Lamp Spa Mode allows the projector to refresh the lamp automatically and continuously after shutdown, which will maintain the electrode to keep it in good condition and extend the lamp life.

To set **Lamp Spa Mode**, go into the **SYSTEM SETUP: Advanced > Lamp Settings > Lamp Spa Mode** menu and press ◀/▶.

However, you can still select for this time to execute Lamp Spa Mode or not for every shutdown. If you want to cancel the Lamp Spa Mode, press ⏻ **POWER** again to skip it when the pop-up message displays to activate the Lamp Spa Mode soon.

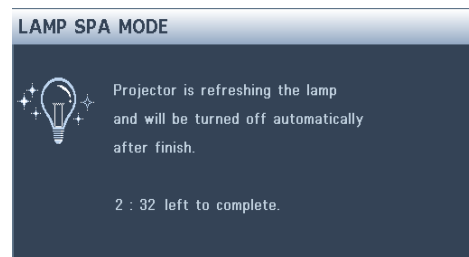
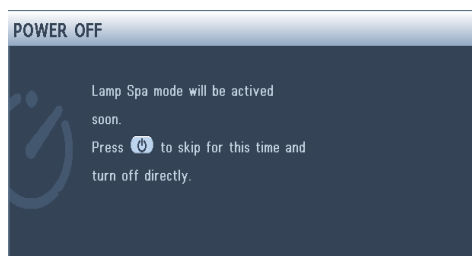

Timing of replacing the lamp

When the **Lamp indicator** lights up red or a message appears suggesting it is time to replace the lamp, please install a new lamp or consult your dealer. An old lamp may cause a malfunction in the projector and in some instances the lamp may explode.

 **Do not attempt to replace the lamp yourself. Contact the qualified service personnel for replacement.**

 **The Lamp indicator light and Temperature warning light will light up if the lamp becomes too hot. See "Indicators" on page 63 for details.**

The following lamp warning displays will remind you to change the lamp.

 **The warning messages below are for reference only. Please follow the actual on-screen instructions to prepare and replace the lamp.**

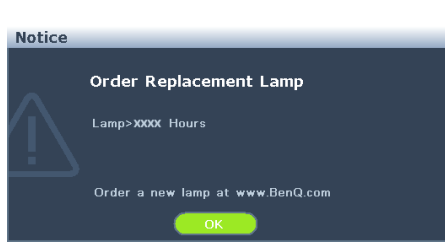
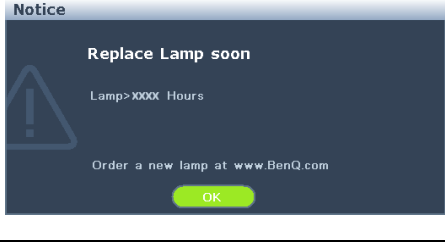
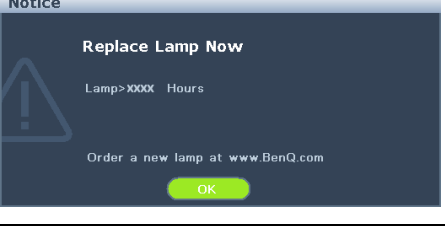
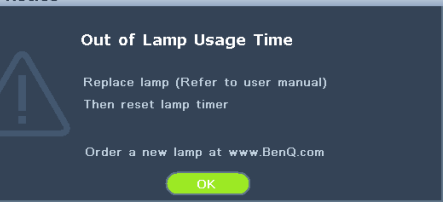
Status	Message
Install a new lamp for optimal performance. If the projector is normally run with Economic selected (" Setting Lamp Mode " on page 57), you may continue to operate the projector until the next lamp warning appears.	 <p>Notice Order Replacement Lamp Lamp>XXXX Hours Order a new lamp at www.BenQ.com OK</p>
A new lamp should be fitted to avoid the inconvenience when the projector runs out of lamp time.	 <p>Notice Replace Lamp soon Lamp>XXXX Hours Order a new lamp at www.BenQ.com OK</p>
It is strongly recommended that you replace the lamp at this stage. The lamp is a consumable item. The lamp brightness diminishes with use. This is normal lamp behavior. You can replace the lamp whenever you notice that the brightness level has significantly diminished.	 <p>Notice Replace Lamp Now Lamp>XXXX Hours Order a new lamp at www.BenQ.com OK</p>
The lamp MUST be replaced before the projector will operate normally.	 <p>Notice Out of Lamp Usage Time Replace lamp (Refer to user manual) Then reset lamp timer Order a new lamp at www.BenQ.com OK</p>

 **"XXXX" shown in the above messages are numbers that vary depending on different models.**

Replacing the lamp (FOR SERVICE PERSONNEL ONLY)

- ⚠ • **Hg - Lamp contains mercury. Manage in accordance with local disposal laws. See www.lamprecycle.org.**
 - **If lamp replacement is performed while the projector is suspended upside-down from the ceiling, make sure that no one is underneath the lamp socket to avoid any possible injury or damage to the human eyes caused by fractured lamp.**
 - **To reduce the risk of electrical shock, always turn the projector off and disconnect the power cord before changing the lamp.**
 - **To reduce the risk of severe burns, allow the projector to cool for at least 45 minutes before replacing the lamp.**
 - **To reduce the risk of injuries to fingers and damage to internal components, use caution when removing lamp glass that has shattered into sharp pieces.**
 - **To reduce the risk of injuries to fingers and/or compromising image quality by touching the lens, do not touch the empty lamp compartment when the lamp is removed.**
 - **This lamp contains mercury. Consult your local hazardous waste regulations to dispose of this lamp in a proper manner.**
 - **To assure optimal performance from the projector, it is recommended that you purchase a BenQ projector lamp for lamp replacement.**
 - **Ensure good ventilation when handling broken lamps. We recommend that you use respirators, safety glasses, goggles or face shield and wear protective clothing such as gloves.**
1. **Turn the power off and disconnect the projector from the power outlet. If the lamp is hot, avoid burns by waiting for approximately 45 minutes until the lamp has cooled.**
 2. **Loosen the screw on the lamp cover.**

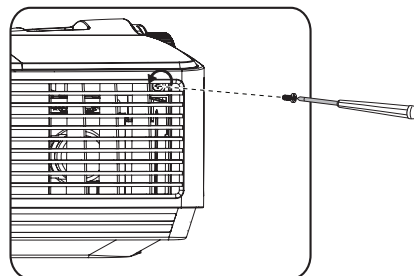

3. Remove the lamp cover by (a) sliding the cover toward the side of the projector and (b) lifting it off.

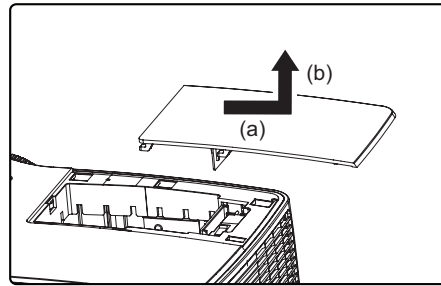

- ⚠️ • **Do not turn the power on with the lamp cover removed.**
- **Do not insert your fingers between the lamp and the projector. The sharp edges inside the projector may cause injuries.**

4. Loosen the screws that secure the lamp.

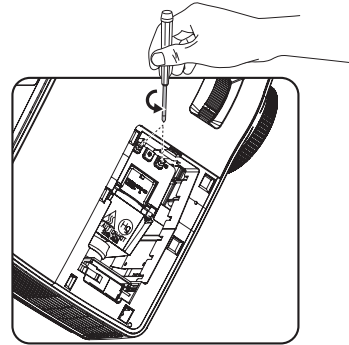

5. Lift the handle so that it stands up. Use the handle to slowly pull the lamp out of the projector.

- ⚠️ • **Pulling it too quickly may cause the lamp to break and scatter broken glass in the projector.**
- **Do not place the lamp in locations where water might splash on it, children can reach it, or near flammable materials.**

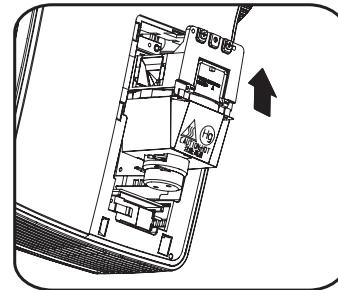

- **Do not insert your hands into the projector after the lamp is removed. If you touch the optical components inside, it could cause color unevenness and distortion of the projected images.**

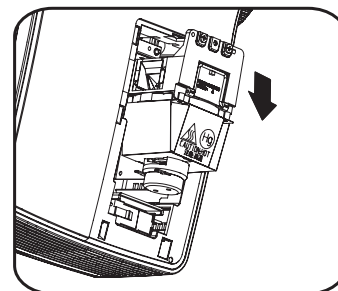

6. Insert the new lamp into the lamp compartment and make sure it fits in the projector.

7. Tighten the screws that secure the lamp.

⚠ • **Loose screw may cause a bad connection, which could result in malfunction.**

- **Do not over tighten the screws.**

8. Ensure the handle is fully laid flat and locked in place.

9. Replace the lamp cover by sliding it into place.

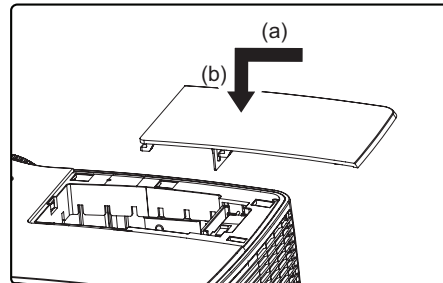
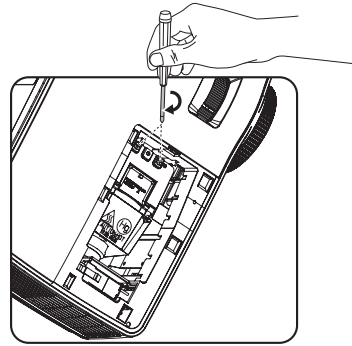

10. Tighten the screw that secures the lamp cover.

⚠ • **Loose screw may cause a bad connection, which could result in malfunction.**

- **Do not over tighten the screw.**

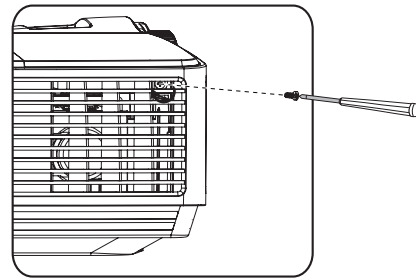

11. Restart the projector.

⚠ **Do not turn the power on with the lamp cover removed.**

Resetting the lamp timer

12. After the startup logo, open the On-Screen Display (OSD) menu. Go to the **SYSTEM SETUP: Advanced > Lamp Settings** menu. Press **Mode/Enter**. The **Lamp Settings** page displays. Press **▼** to highlight **Reset lamp timer** and press **Mode/Enter**. A warning message displays asking if you want to reset the lamp timer. Highlight **Reset** and press **Mode/Enter**. The lamp time will be reset to '0'.

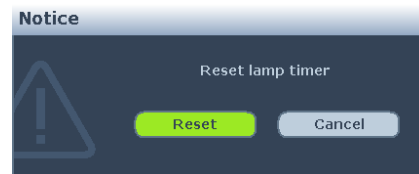

⚠ **Do not reset if the lamp is not new or replaced as this could cause damage.**

Indicators

Light			Status & Description
POWER	TEMP	LAMP	
System Message			
Orange	Off	Off	Stand-by mode
Green Flashing	Off	Off	Powering up
Green	Off	Off	Normal operation
Orange Flashing	Off	Off	Normal power-down cooling
Red	Off	Off	Download
Green	Off	Red	CW start fail
Red Flashing	Off	Off	Scaler shutdown fail (data aboard)
Burn-In Messages			
Green	Off	Off	Burn-in ON
Green	Green	Green	Burn-in OFF
Lamp Error Messages			
Off	Off	Red	Lamp I error in normal operation
Off	Off	Orange Flashing	Lamp is not lit up
Thermal Error Messages			
Red	Red	Off	Fan 1 error (the actual fan speed is $\pm 25\%$ outside the desired speed)
Red	Red Flashing	Off	Fan 2 error (the actual fan speed is $\pm 25\%$ outside the desired speed)
Green	Red	Off	Temperature 1 error (over limited temperature)

Troubleshooting

① The projector does not turn on.

Cause	Remedy
There is no power from the power cable.	Plug the power cord into the AC inlet on the projector, and plug the power cord into the power outlet. If the power outlet has a switch, make sure that it is switched on.
Attempting to turn the projector on again during the cooling process.	Wait until the cooling down process has completed.

① No picture

Cause	Remedy
The video source is not turned on or connected correctly.	Turn the video source on and check that the signal cable is connected correctly.
The projector is not correctly connected to the input signal device.	Check the connection.
The input signal has not been correctly selected.	Select the correct input signal with the Source key on the remote control.

① Blurred image

Cause	Remedy
The projection lens is not correctly focused.	Adjust the focus of the lens using the focus ring.
The projector and the screen are not aligned properly.	Adjust the projection angle and direction as well as the height of the unit if necessary.
The lens cover is still closed.	Open the lens cover.

① Remote control does not work

Cause	Remedy
The battery is out of power.	Replace the battery with new one.
There is an obstacle between the remote control and the projector.	Remove the obstacle.
You are too far away from the projector.	Stand within 8 meters (26 feet) of the projector.

① The password is incorrect

Cause	Remedy
You do not remember the password.	Please see " Entering the password recall procedure " on page 27 for details.

Specifications

 All specifications are subject to change without notice.

Optical

Resolution

(ES500)

800 x 600 SVGA

(EX501)

1024 x 768 XGA

Display system

I-CHIP DMD

Lens F/Number

F = 2.5 to 2.7

f = 22.08 to 24.28 mm

Offset

130%

Zoom ratio

1.1X

Lamp

190 W lamp

Electrical

Power supply

AC100-240V, 2.6 A,

50-60 Hz (Automatic)

Power consumption

265 W (Max); < 0.5 W (Standby)

Mechanical

Weight

1.94 Kg (4.3 lbs)

Control

RS-232 serial control

9 pin x 1

IR receiver x 1

Mini-B USB x 1

(Firmware download & page up/down)

Input terminals

Computer input

RGB input

D-Sub 15-pin (female) x 1

Video signal input

VIDEO

RCA jack x 1

SD/HDTV signal input

Analog - Component RCA jack x 3

(through RGB input)

Environmental Requirements

Operating temperature

0°C-40°C at sea level

Operating relative humidity

10%-90% (without condensation)

Operating altitude

0-1499 m at 0°C-35°C

1500-3000* m at 0°C-30°C (with High

Altitude Mode on)

 Lamp life results will vary depending on environmental conditions and usage.

Dimensions

285.0 mm (W) x 117.2 mm (H) x 205.8 mm (D)

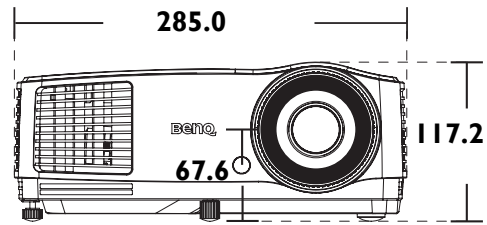
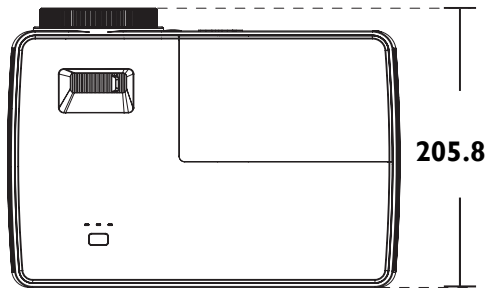

Unit: mm

Ceiling mount installation

Ceiling Mount screw: M4

(Max L = 25 mm; Min L = 20 mm)

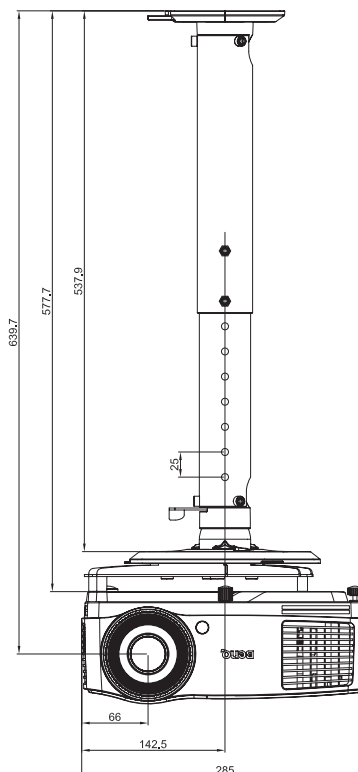
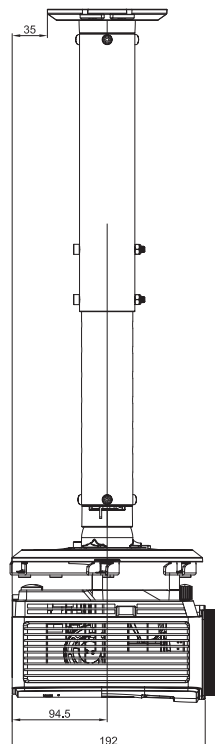
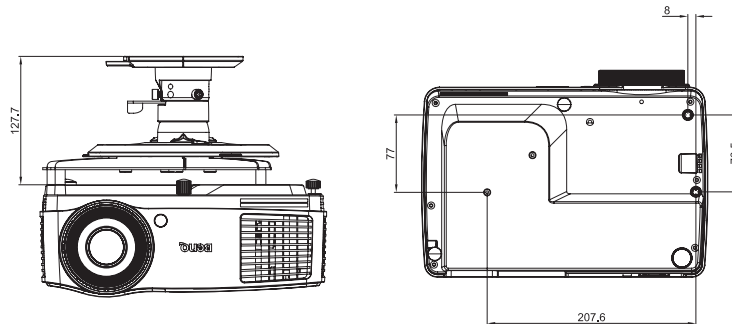

Unit: mm

Timing chart

Supported timing for PC input

Resolution	Timing	Horizontal frequency (KHz)	Vertical frequency (Hz)	Pixel Frequency (MHz)	3D Field Sequential	3D top bottom	3D side by side
640 x 480	VGA_60	59.94	31.469	25.175	⊙	⊙	⊙
	VGA_72	72.809	37.861	31.500			
	VGA_75	75	37.5	31.500			
	VGA_85	85.008	43.269	36.000			
720 x 400	720 x 400_70	70.087	31.469	28.3221			
800 x 600	SVGA_60	60.317	37.879	40.000	⊙	⊙	⊙
	SVGA_72	72.188	48.077	50.000			
	SVGA_75	75	46.875	49.500			
	SVGA_85	85.061	53.674	56.250			
	SVGA_120 (Reduce Blanking)	119.854	77.425	83.000	⊙		
1024 x 768	XGA_60	60.004	48.363	65.000	⊙	⊙	⊙
	XGA_70	70.069	56.476	75.000			
	XGA_75	75.029	60.023	78.750			
	XGA_85	84.997	68.667	94.500			
	XGA_120 (Reduce Blanking)	119.989	97.551	115.5	⊙		
1152 x 864	1152 x 864_75	75	67.5	108			
1024 x 576	BenQ Notebook Timing	60	35.82	46.966			
1024 x 600	BenQ Notebook Timing	64.995	41.467	51.419			
1280 x 720	1280 x 720_60	60	45	74.250	⊙	⊙	⊙
	1280 x 720_120	120	90.000	148.500	⊙		
1280 x 768	1280 x 768_60	59.87	47.776	79.5	⊙	⊙	⊙
1280 x 800	WXGA_60	59.81	49.702	83.500	⊙	⊙	⊙
	WXGA_75	74.934	62.795	106.500			
	WXGA_85	84.88	71.554	122.500			
	WXGA_120 (Reduce Blanking)	119.909	101.563	146.25	⊙		
1280 x 1024	SXGA_60	60.02	63.981	108.000		⊙	⊙
	SXGA_75	75.025	79.976	135.000			
	SXGA_85	85.024	91.146	157.500			
1280 x 960	1280 x 960_60	60	60	108.000		⊙	⊙
	1280 x 960_85	85.002	85.938	148.500			
1360 x 768	1360 x 768_60	60.015	47.712	85.5		⊙	⊙
1440 x 900	WXGA+_60	59.887	55.935	106.500		⊙	⊙
1400 x 1050	SXGA+_60	59.978	65.317	121.750		⊙	⊙
1600 x 1200	UXGA	60	75	162.000		⊙	⊙
1680 x 1050	1680 x 1050_60	59.954	65.29	146.25		⊙	⊙

1920 x 1080	1920 x 1080_60 (Reduce Blanking)	67.5	60	148.5			
1920 x 1200	1920 x 1200_60 (Reduce Blanking)	59.95	74.038	154.000			
640 x 480 @67Hz	MAC13	66.667	35	30.240			
832 x 624 @75Hz	MAC16	74.546	49.722	57.280			
1024 x 768 @75Hz	MAC19	75.02	60.241	80.000			
1152 x 870 @75Hz	MAC21	75.06	68.68	100.000			

- The timings showing above may not be supported due to EDID file and VGA graphic card limitations. It is possible that some timings cannot be chosen.

Supported timing for Video input

Video mode	Horizontal Frequency (kHz)	Vertical Frequency (Hz)	Color sub-carrier Frequency (MHz)	3D Field Sequential
NTSC	15.73	60	3.58	⊙
PAL	15.63	50	4.43	
SECAM	15.63	50	4.25 or 4.41	
PAL-M	15.73	60	3.58	
PAL-N	15.63	50	3.58	
PAL-60	15.73	60	4.43	
NTSC4.43	15.73	60	4.43	

Supported timing for Component-YPbPr input

Timing	Resolution	Horizontal Frequency (KHz)	Vertical Frequency (Hz)	Pixel Frequency (MHz)	3D Field Sequential
480i	720 x 480	15.73	59.94	13.5	⊙
480p	720 x 480	31.47	59.94	27	⊙
576i	720 x 576	15.63	50	13.5	
576p	720 x 576	31.25	50	27	
720/50p	1280 x 720	37.5	50	74.25	
720/60p	1280 x 720	45.00	60	74.25	⊙
1080/50i	1920 x 1080	28.13	50	74.25	
1080/60i	1920 x 1080	33.75	60	74.25	
1080/24P	1920 x 1080	27	24	74.25	
1080/25P	1920 x 1080	28.13	25	74.25	
1080/30P	1920 x 1080	33.75	30	74.25	
1080/50P	1920 x 1080	56.25	50	148.5	
1080/60P	1920 x 1080	67.5	60	148.5	

Warranty and Copyright information

Patents

Please go to <http://patmarking.benq.com/> for the details of BenQ projector patent coverage.

Limited warranty

BenQ warrants this product against any defects in material and workmanship, under normal usage and storage.

Proof of purchase date will be required with any warranty claim. In the event this product is found to be defective within the warranty period, BenQ's only obligation and your exclusive remedy shall be replacement of any defective parts (labor included). To obtain warranty service, immediately notify the dealer from which you purchased the product of any defects.

Important: The above warranty shall be void if the customer fails to operate the product in accordance with BenQ's written instructions, especially the ambient humidity must be in-between 10% and 90%, temperature in-between 0°C and 35°C, altitude lower than 4920 feet, and avoiding to operate the projector in a dusty environment. This warranty gives you specific legal rights, and you may have other rights which vary from country to country.

For other information, please visit www.BenQ.com.

Copyright

Copyright 2014 by BenQ Corporation. All rights reserved. No part of this publication may be reproduced, transmitted, transcribed, stored in a retrieval system or translated into any language or computer language, in any form or by any means, electronic, mechanical, magnetic, optical, chemical, manual or otherwise, without the prior written permission of BenQ Corporation.

Disclaimer

BenQ Corporation makes no representations or warranties, either expressed or implied, with respect to the contents hereof and specifically disclaims any warranties, merchantability or fitness for any particular purpose. Further, BenQ Corporation reserves the right to revise this publication and to make changes from time to time in the contents hereof without obligation to notify any person of such revision or changes.

*DLP, Digital Micromirror Device and DMD are trademarks of Texas Instruments. Others are copyrights of their respective companies or organizations.