



MH684

Digital Projector

User Manual

Table of contents

Important safety instructions	3	Operating in a high altitude environment.....	43
Introduction	7	Adjusting the sound	43
Projector features.....	7	Using the test pattern.....	44
Shipping contents	8	Using the teaching templates.....	45
Projector exterior view.....	9	Using the quick install.....	45
Controls and functions	11	Shutting down the projector	46
Positioning your projector	20	Menu operation	47
Choosing a location.....	20	Maintenance	58
Obtaining a preferred projected image size.....	21	Care of the projector.....	58
Connection	23	Lamp information	59
Connecting video source devices.....	24	Troubleshooting	66
Playing sound through the projector	25	Specifications	67
Operation	26	Projector specifications.....	67
Starting up the projector	26	Dimensions	68
Adjusting the projected image	27	Timing chart.....	69
Using the menus.....	30	Warranty and Copyright information	75
Securing the projector	31		
Utilizing the password function	31		
Switching input signal	34		
Magnifying and searching for details ...	35		
Selecting the aspect ratio	35		
Optimizing the image	37		
Setting the presentation timer	41		
Remote paging operations	42		
Freezing the image	42		
Hiding the image.....	42		
Locking control keys	43		

Important safety instructions

Your projector is designed and tested to meet the latest standards for safety of information technology equipment. However, to ensure safe use of this product, it is important that you follow the instructions mentioned in this manual and marked on the product.

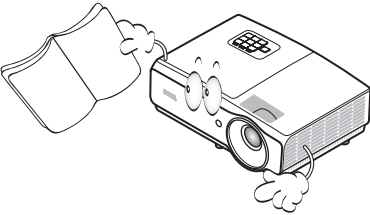
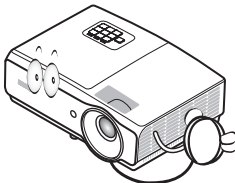
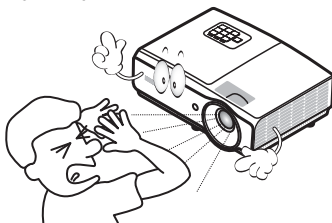
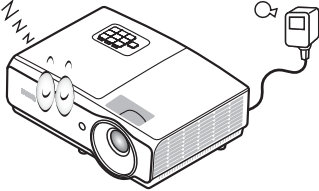
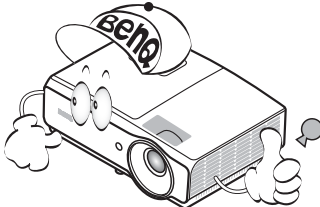
Safety Instructions	
<p>1. Please read this manual before you operate your projector. Save it for future reference.</p> 	<p>4. Always open the lens shutter or remove the lens cap when the projector lamp is on.</p> 
<p>2. Do not look straight at the projector lens during operation. The intense light beam may damage your eyes.</p> 	<p>5. In some countries, the line voltage is NOT stable. This projector is designed to operate safely within a mains voltage between 100 to 240 volts AC, but could fail if power cuts or surges of ± 10 volts occur. In areas where the mains voltage may fluctuate or cut out, it is recommended that you connect your projector through a power stabilizer, surge protector or uninterruptible power supply (UPS).</p> 
<p>3. Refer servicing to qualified service personnel.</p> 	

Safety Instructions

6. Do not block the projection lens with any objects when the projector is under operation as this could cause the objects to become heated and deformed or even cause a fire. To temporarily turn off the lamp, press **ECO BLANK** on the projector or remote control.

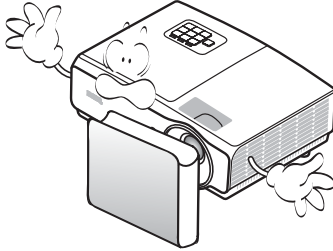

7. The lamp becomes extremely hot during operation. Allow the projector to cool for approximately 45 minutes prior to removing the lamp assembly for replacement.

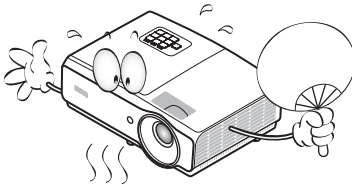

8. Do not operate lamps beyond the rated lamp life. Excessive operation of lamps beyond the rated life could cause them to break on rare occasions.

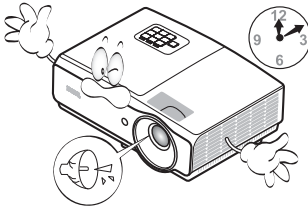

9. Never replace the lamp assembly or any electronic components unless the projector is unplugged.

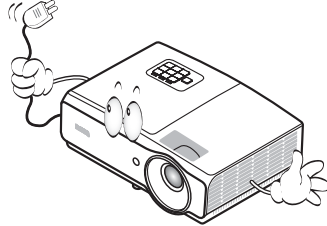

10. Do not place this product on an unstable cart, stand, or table. The product may fall, sustaining serious damage.

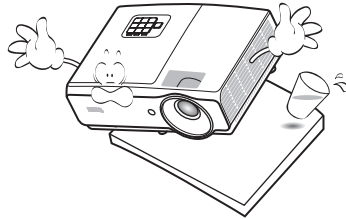

11. Do not attempt to disassemble this projector. There are dangerous high voltages inside which may cause death if you should come into contact with live parts. The only user serviceable part is the lamp which has its own removable cover.

Under no circumstances should you ever undo or remove any other covers. Refer servicing only to suitably qualified professional service personnel.

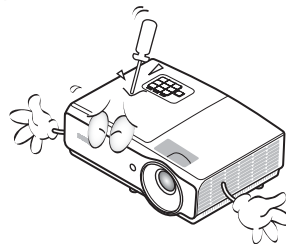

Safety Instructions (Continued)

12. When the projector is under operation, you may sense some heated air and odor from its ventilation grill. It is a normal phenomenon and not a product defect.
13. Do not place this projector in any of the following environments.
- Space that is poorly ventilated or confined. Allow at least 50 cm clearance from walls and free flow of air around the projector.
 - Locations where temperatures may become excessively high, such as the inside of a car with all windows rolled up.
 - Locations where excessive humidity, dust, or cigarette smoke may contaminate optical components, shortening the projector's life span and darkening the image.

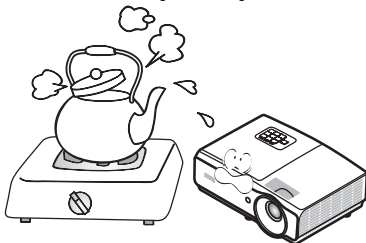

- Locations near fire alarms
- Locations with an ambient temperature above 40°C / 104°F
- Locations where the altitudes are higher than 3000 m (10000 feet).

3000 m
(10000 feet)

0 m
(0 feet)

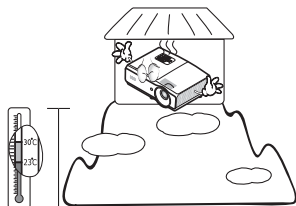

14. Do not block the ventilation holes.
- Do not place this projector on a blanket, bedding or any other soft surface.
 - Do not cover this projector with a cloth or any other item.
 - Do not place inflammables near the projector.

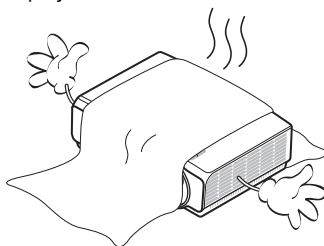

If the ventilation holes are seriously obstructed, overheating inside the projector may result in a fire.

15. Always place the projector on a level, horizontal surface during operation.
- Do not use if tilted at an angle of more than 10 degrees left to right, nor at angle of more than 15 degrees front to back. Using the projector when it is not fully horizontal may cause a malfunction of, or damage to, the lamp.

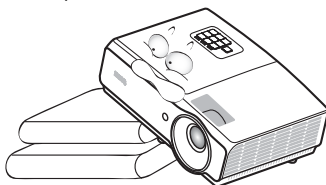

Safety Instructions (Continued)

16. Do not stand the projector on end vertically. Doing so may cause the projector to fall over, causing injury or resulting in damage to the projector.

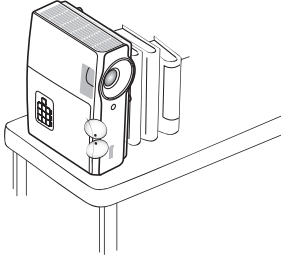

17. Do not step on the projector or place any objects upon it. Besides probable physical damage to the projector, doing so may result in accidents and possible injury.

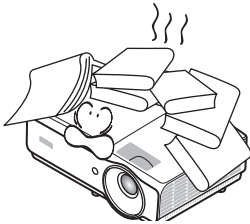

18. Do not place liquids near or on the projector. Liquids spilled into the projector may cause it to fail. If the projector does become wet, disconnect it from the power supply's wall socket and call BenQ to have the projector serviced.

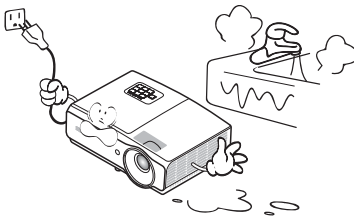

19. This product is capable of displaying inverted images for ceiling mount installation.



Use only BenQ's Ceiling Mount Kit for mounting the projector and ensure it is securely installed.

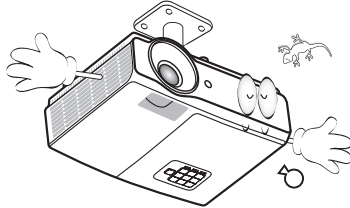

Ceiling mounting the projector

We want you to have a pleasant experience using your BenQ projector, so we need to bring this safety matter to your attention to prevent possible damage to person and property.

If you intend to mount your projector on the ceiling, we strongly recommend that you use a proper fitting BenQ projector ceiling mount kit and that you ensure it is securely and safely installed.

If you use a non-BenQ brand projector ceiling mount kit, there is a safety risk that the projector may fall from the ceiling due to an improper attachment through the use of the wrong gauge or length screws. You can purchase a BenQ projector ceiling mount kit from the place you purchased your BenQ projector. BenQ recommends that you also purchase a separate Kensington lock compatible security cable and attach it securely to both the Kensington lock slot on the projector and the base of the ceiling mount bracket. This will perform the secondary role of restraining the projector should its attachment to the mounting bracket become loose.



Hg - Lamp contains mercury. Manage in accordance with local disposal laws. See www.lamprecycle.org.

Introduction

Projector features

The projector offers the following features

- **SmartEco™ starts your dynamic power saving**
The SmartEco™ technology offers a new way of operating the projector lamp system and saves lamp power up to 70% depending on the content brightness level.
- **Longer lamp life with SmartEco™ technology**
The SmartEco™ technology lowers the power consumption and increases the lamp life when SmartEco mode is selected.
- **HDMI/MHL compatible**
You can project the content from your smart devices via HDMI-1/MHL connection.
- **ECO BLANK saves 70% of lamp power**
By pressing the **ECO BLANK** button to hide the image and immediately lower 70% of the lamp power at the same time.
- **USB MINI-B** jack to use the page up/down commands (like Microsoft PowerPoint) using the remote control when connected a PC.
- **USB TYPE A** jack to support 5V/1.5A output.
- **Less than 0.5W in standby condition**
Less than 0.5W power consumption under standby mode.
- **Filter Free**
Filter free design to lower maintenance and operating costs.
- **One-key auto-adjustment**
Pressing **AUTO** on the keypad or remote control to show the best picture quality immediately.
- **Built-in 10W speaker(s)**
Built-in 10W speaker(s) providing mixed mono audio when an audio input is connected.
- **Quick Cooling, Auto Power Off, Signal Power On, Direct Power On Quick Cooling** function speeds up the cooling process when turning off the projector. **Auto Power Off** function allows the projector to turn off automatically if no input signal is detected after a set period of time. **Signal Power On** function turns on your projector automatically once detecting the signal input and **Direct Power On** boots up the projector automatically when the power is connected.
- **Instant Restart**
Selectable **Instant Restart** function enables you to restart the projector immediately within 90 seconds after turning it off.
- **3D Function supported**
Various 3D formats make the 3D function more flexible. By presenting the depth of the images, you can wear BenQ 3D glasses to enjoy the 3D movies, videos and sporting events in a more realistic way.
- Auto keystone function to correct image keystone automatically.
-  **The apparent brightness of the projected image will vary depending on the ambient lighting conditions, selected input signal contrast/brightness settings, and is directly proportional to projection distance.**
- **The lamp brightness will decline over time and may vary within the lamp manufacturers specifications. This is normal and expected behavior.**

Shipping contents

Carefully unpack and verify that you have all of the items shown below. If any of these items are missing, please contact your place of purchase.

Standard accessories

 The supplied accessories will be suitable for your region, and may differ from those illustrated.

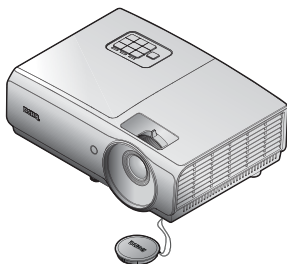

Projector

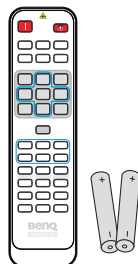

Remote control with battery

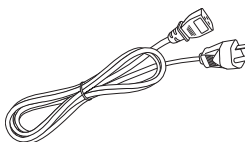

Power cord

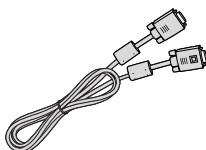

VGA cable

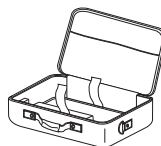

Soft carry case



Quick start guide



User manual CD



Warranty card*

Optional accessories

1. Spare lamp kit
2. Ceiling mount kit
3. Soft carry case
4. 3D glasses
5. Qcast

*The warranty card is only supplied in some specific regions. Please consult your dealer for detailed information.

Projector exterior view

Front/upper side

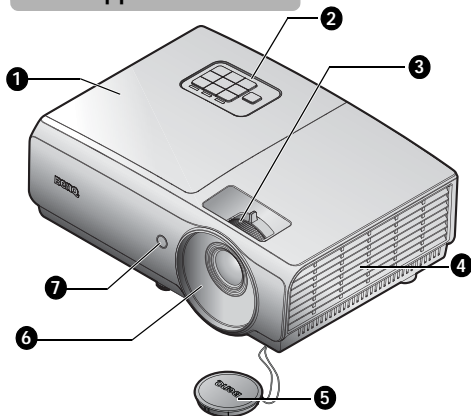

1. Lamp compartment cover
2. External control panel
(See "Projector" on page 11 for details.)
3. Focus ring and Zoom ring
4. Vent (cool air intake)
5. Lens cap & string
6. Projection lens
7. Front IR remote sensor

Rear/lower side

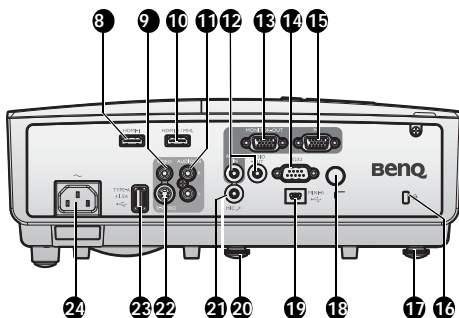

8. HDMI-1 input jack
9. VIDEO input jack
10. HDMI-2/MHL input jack
11. Audio (L/R) input jack
12. Audio input/output jack
13. MONITOR-OUT output jack
14. RS232 control port
15. PC input jack
16. Kensington anti-theft lock slot
17. Rear adjuster foot
18. Rear IR remote sensor
19. USB Mini-B port
20. Front adjuster foot
21. Microphone jack
22. S-VIDEO input jack
23. USB Type-A port
24. AC power cord inlet

Bottom side

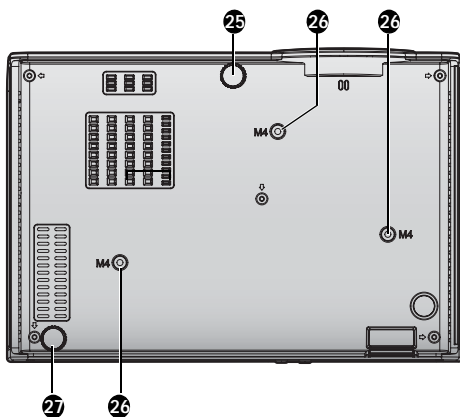

- 25. Front adjuster foot
- 26. Ceiling mount holes
- 27. Rear adjuster foot

Controls and functions

Projector

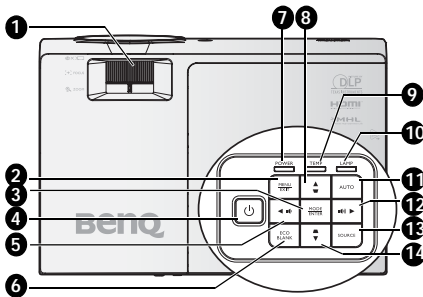

1. **FOCUS/ZOOM Ring**
Used to adjust the projected image appearance. See ["Fine-tuning the image size and clarity" on page 27](#) for details.
2. **MENU/EXIT**
Turns on the On-Screen Display (OSD) menu. Goes back to previous OSD menu, exits and saves menu settings. See ["Using the menus" on page 30](#) for details.
3. **MODE/ENTER**
Selects an available picture setup mode. See ["Selecting a picture mode" on page 37](#) for details.
4. **POWER**
Enacts the selected On-Screen Display (OSD) menu item. See ["Using the menus" on page 30](#) for details.
Toggles the projector between standby mode and on.
See ["Starting up the projector" on page 26](#) and ["Shutting down the projector" on page 46](#) for details.
5. **Left/ Decrease volume level**
Decreases volume. See ["Adjusting the sound level" on page 44](#) for details.
6. **ECO BLANK**
Used to hide the screen picture. See ["Hiding the image" on page 42](#) for details.
7. **POWER indicator light**
Lights up or flashes when the projector is under operation. See ["Indicators" on page 65](#) for details.
8. **Keystone/Arrow keys (▲/▲ Up)**
Manually corrects distorted images resulting from an angled projection. See ["Correcting 2D Keystone" on page 28](#) for details.
9. **TEMPERature indicator light**
Lights up red if the projector's temperature becomes too high. See ["Indicators" on page 65](#) for details.
10. **LAMP indicator light**
Indicates the status of the lamp. Lights up or flashes when the lamp has developed a problem. See ["Indicators" on page 65](#) for details.
11. **AUTO**
Automatically determines the best picture timings for the displayed image. See ["Auto-adjusting the image" on page 27](#) for details.
12. **Right/ Increase volume level**
Increases volume. See ["Adjusting the sound level" on page 44](#) for details.
When the On-Screen Display (OSD) menu is activated, the #5, #8, #12, and #14 keys are used as directional arrows to select the desired menu items and to make adjustments. See ["Using the menus" on page 30](#) for details.
13. **SOURCE**
Displays the source selection bar. See ["Switching input signal" on page 34](#) for details.
14. **Keystone/Arrow keys (▼/▼ Down)**
Manually corrects distorted images resulting from an angled projection. See ["Correcting 2D Keystone" on page 28](#) for details.

Remote Control

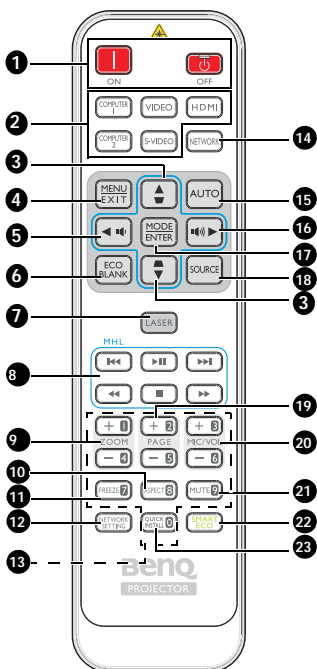

1. **ON / OFF**
Toggles the projector between standby mode and on.
2. **Source selection buttons**
Selects an input source for display.
3. **Keystone/Arrow keys (▼/▲ Up, ▲/▼ Down)**
Manually corrects distorted images resulting from an angled projection.
4. **MENU/EXIT**
Turns on the On-Screen Display (OSD) menu. Goes back to previous OSD menu, exits and saves menu settings.
5. **◀ Left/ ▶ Right**
Decreases the projector volume.
6. **ECO BLANK**
Used to hide the screen picture.

7. **LASER**
Emits visible laser pointer light for presentation purposes.
8. **MHL control buttons**
Goes to the previous file/Plays/Pauses/ Fastforwards during media playback. Only available when controlling your smart device in MHL mode.
9. **ZOOM+/ZOOM-**
Magnifies or reduces the projected picture size.
10. **ASPECT**
Selects the display aspect ratio.
11. **FREEZE**
Freezes the projected image.
12. **NETWORK SETTING**
Displays the **Network Settings** OSD menu.
13. **Numeric buttons**
Enters numbers in network settings.
14. **NETWORK**
Selects Network Display as the input signal source.
15. **AUTO**
Automatically determines the best picture timings for the displayed image. When there is no OSD menu and at MHL source, long press for 3 seconds to switch between MHL mode and DLP mode on remote control for MHL keys.

☞ **Numeric buttons 1, 2, 3, 4 cannot be pressed when asked to enter password.**

16. ► **Right/** 

Increases the projector volume.

When the On-Screen Display (OSD) menu is activated, the #3, #5, and #16 keys are used as directional arrows to select the desired menu items and to make adjustments.

When MHL function, the #3, #5 and #16 are used as directional arrows. #4 for **MENU/EXIT** and #17 for **MODE/ENTER**.

17. **MODE/ENTER**

Selects an available picture setup mode. Activates the selected On-Screen Display (OSD) menu item.

18. **SOURCE**

Displays the source selection bar.

19. **PAGE +/PAGE -**

Operate your display software program (on a connected PC) which responds to page up/down commands (like Microsoft PowerPoint).

20. **MIC/VOL +/MIC/VOL -**

Microphone input level adjustment.

21. **MUTE**

Toggles projector audio between on and off.

22. **SMART ECO**

Switch the lamp mode between Eco, Normal and SmartEco.

23. **QUICK INSTALL**

Displays the **Quick Install** OSD menu.

 When the projector is under MHL mode, The keypad on projector should be with the same definition of the key on remote control.

Operating the LASER pointer

The Laser Pointer is a presentation aid for professionals. It emits a beam of red light when you press it.

The laser beam is visible. It is necessary to press and hold LASER for continuous output.



Do not look into the laser light window or shine the laser light beam on yourself or others. See the warning messages on the back of the remote control prior to using it.

The laser pointer is not a toy. Parents should be mindful of the dangers of laser energy and keep this remote control out of the reach of children.

Avoid Exposure
Laser radiation is emitted from this aperture



Controlling your smart device with the remote control

When the projector projects the contents from your MHL compatible smart device, you can use the remote control to control your smart device.

To enter the MHL mode, press and hold **AUTO** for 3 seconds. The following buttons are available for controlling your smart device, Arrow keys (▼/▲ **Up**, ▲/▼ **Down**, ◀ **Left**, ▶ **Right**), **MENU/EXIT**, **MHL control buttons**.

To leave the MHL mode, press and hold **AUTO** for 3 seconds.

(Available in Japan region)

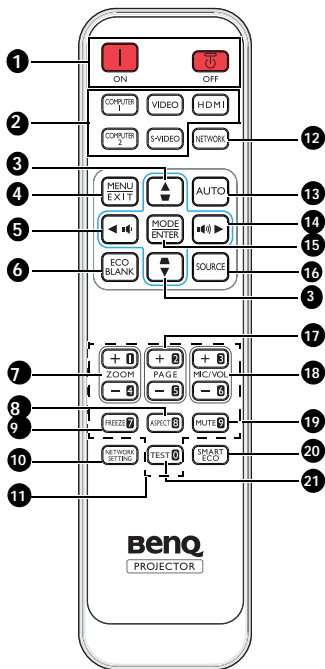

1. **ON / OFF**
Toggles the projector between standby mode and on.
2. **Source selection buttons**
Selects an input source for display.
3. **Keystone/Arrow keys (▲/▼ Up, ▼/▲ Down)**
Manually corrects distorted images resulting from an angled projection.
4. **MENU/EXIT**
Turns on the On-Screen Display (OSD) menu. Goes back to previous OSD menu, exits and saves menu settings.
5. **Left/ Right**
Decreases the projector volume.
6. **ECO BLANK**
Used to hide the screen picture.

7. **ZOOM+/ZOOM-**
Magnifies or reduces the projected picture size.
8. **ASPECT**
Selects the display aspect ratio.
9. **FREEZE**
Freezes the projected image.
10. **NETWORK SETTING**
Displays the **Network Settings** OSD menu.
11. **Numeric buttons**
Enters numbers in network settings.

☞ **Numeric buttons 1, 2, 3, 4 cannot be pressed when asked to enter password.**

12. **NETWORK**
Selects Network Display as the input signal source.
13. **AUTO**
Automatically determines the best picture timings for the displayed image. When there is no OSD menu and at MHL source, long press for 3 seconds to switch between MHL mode and DLP mode on remote control for MHL keys.
14. **Right/ Loudspeaker**
Increases the projector volume. When the On-Screen Display (OSD) menu is activated, the #3, #5, and #14 keys are used as directional arrows to select the desired menu items and to make adjustments. When MHL function, the #3, #5 and #14 are used as directional arrows. #4 for **MENU/EXIT** and #15 for **MODE/ENTER**.
15. **MODE/ENTER**
Selects an available picture setup mode. Activates the selected On-Screen Display (OSD) menu item.
16. **SOURCE**
Displays the source selection bar.
17. **PAGE +/PAGE -**
Operate your display software program (on a connected PC) which responds to page up/down commands (like Microsoft PowerPoint).

18. **MIC/VOL +/MIC/VOL -**
Microphone input level adjustment.
19. **MUTE**
Toggles projector audio between on and off.
20. **SMART ECO**
Switch the lamp mode between Eco, Normal and SmartEco.
21. **TEST**
Displays the test pattern.

Remote control effective range

Infra-Red (IR) remote control sensor is located on the front and the rear of the projector. The remote control must be held at an angle within 30 degrees perpendicular to the projector's IR remote control sensor to function correctly. The distance between the remote control and the sensor should not exceed 8 meters (~ 26 feet).

Make sure that there are no obstacles between the remote control and the IR sensor on the projector that might obstruct the infra-red beam.

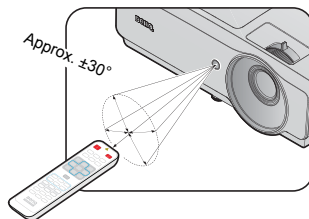
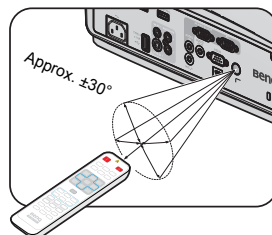

Replacing the remote control battery

1. To open the battery cover, turn the remote control over to view its back, push on the finger grip on the cover and slide it up in the direction of the arrow as illustrated. The cover will slide off.
2. Remove any existing batteries (if necessary) and install two AAA batteries observing the battery polarities as indicated in the base of the battery compartment. Positive (+) goes to positive and negative (-) goes to negative.
3. Refit the cover by aligning it with the base and sliding it back down into position. Stop when it clicks into place.

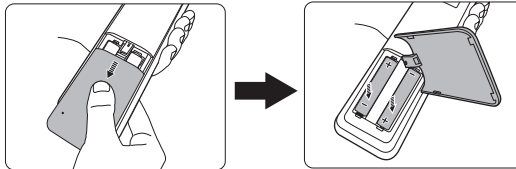

- **Avoid excessive heat and humidity.**
- **There may be battery damage if the battery is incorrectly replaced.**
- **Replace only with the same or equivalent type recommended by the battery manufacturer.**
- **Dispose of the used battery according to the battery manufacturer's instructions.**
- **Never throw a battery into a fire. There may be danger of an explosion.**
- **If the battery is dead or if you will not be using the remote control for a long time, remove the battery to prevent damage to the remote control from possible battery leakage.**

How to setup MH684 with Video Stream Dongle-QCast?

This dongle is an optional accessory, which allows you to perform a wireless projection from your smart device or computer. To purchase the QCast dongle, contact your local dealer.

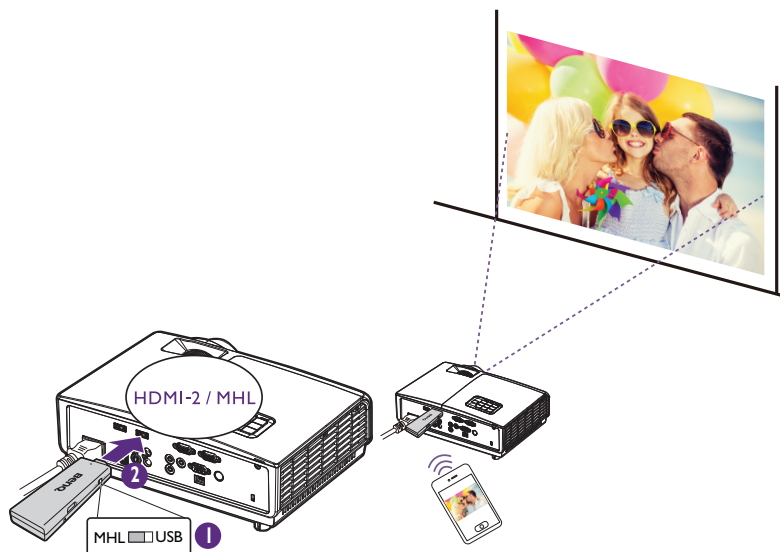

Step1: Connecting the dongle to your MH684 projector

The dongle can be activated via HDMI-2/MHL port on your projector.

Make sure the projector is powered on before making the connection.

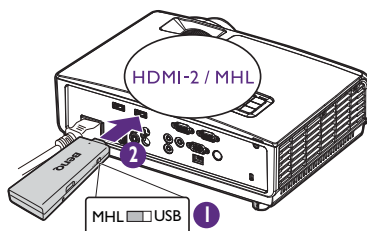

1. Slide the switcher on the dongle to **MHL**.
2. Connect the dongle to the HDMI-2/MHL port of your MH684 projector. The dongle is then activated and the LED indicator lights up in solid blue.

Step2: Installing BenQ QCast on your mobile device/ computer

Once the dongle has been connected to your projector successfully, you are requested to download and install an app/software named **BenQ QCast** to your mobile device/ computer, The dongle needs to work with **BenQ QCast** to perform wireless media streaming.

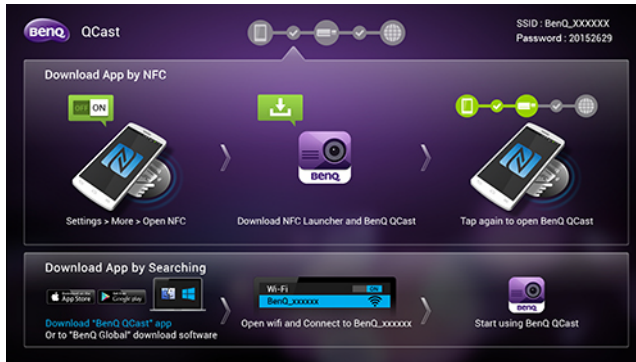

Step3: Working with BenQ QCast

Once **BenQ QCast** has been installed and launched successfully, you are ready to perform wireless media streaming and enjoy the wireless projection. Simply tap **Mirror** from **BenQ QCast** and follow the on-screen instructions.

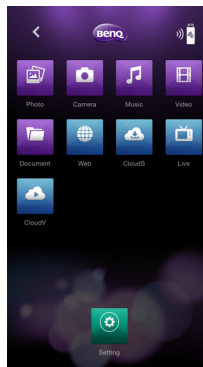

- If the device has been connected to a wireless AP, you can screencast the web content and the files stored on your mobile device.
 - If the device is not connected to a wireless AP, you can screencast the files stored on your mobile device only. Functions that are not available will be grayed out.
- Please refer to the QCast User Guide for more details.

Positioning your projector

Choosing a location

Your projector is designed to be installed in one of four possible installation locations:

1. Front Table

Select this location with the projector placed on a table in front of the screen. This is the most common way to position the projector for quick setup and portability.

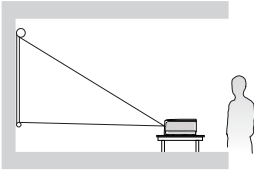

2. Rear Table

Select this location with the projector placed on a table behind the screen. Note that a special rear projection screen is required.

*Set **Rear Table** in the **SYSTEM SETUP: Basic > Projector Installation** menu after you turn the projector on.

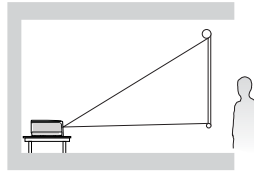

3. Front Ceiling

Select this location with the projector suspended upside-down from the ceiling in front of the screen.

Purchase the BenQ Projector Ceiling Mounting Kit from your dealer to mount your projector on the ceiling.

*Set **Front Ceiling** in the **SYSTEM SETUP: Basic > Projector Installation** menu after you turn the projector on.

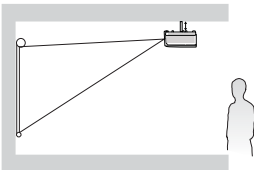

4. Rear Ceiling

Select this location with the projector suspended upside-down from the ceiling behind the screen.

Note that a special rear projection screen and the BenQ Projector Ceiling Mounting Kit are required for this installation location.

*Set **Rear Ceiling** in the **SYSTEM SETUP: Basic > Projector Installation** menu after you turn the projector on.

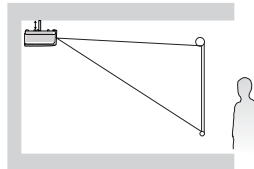

Your room layout or personal preference will dictate which installation location you select. Take into consideration the size and position of your screen, the location of a suitable power outlet, as well as the location and distance between the projector and the rest of your equipment.

Obtaining a preferred projected image size

The distance from the projector lens to the screen, the zoom setting (if available), and the video format each factors in the projected image size.

Projection dimensions

Refer to "Dimensions" on page 68 for the center of lens dimensions of this projector before calculating the appropriate position.

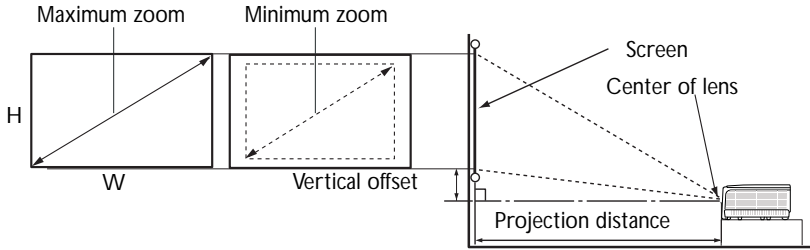

The screen aspect ratio is 16:9 and the projected picture is 16:9.

Screen size				Distance from screen [mm]			Offset [mm]
Diagonal		Width	Height	Min Dis- tance	Average	Max Dis- tance	A [mm] @ Wide mode
inch	mm	mm	mm				
50	1270	1107	623	1273	1461	1649	93
60	1524	1328	747	1528	1753	1979	112
70	1778	1550	872	1782	2046	2309	131
80	2032	1771	996	2037	2338	2639	149
90	2286	1992	1121	2291	2630	2969	168
100	2540	2214	1245	2546	2922	3299	187
110	2794	2435	1370	2800	3214	3628	205
120	3048	2657	1494	3055	3507	3957	224
130	3302	2878	1619	3310	3799	4288	243
140	3556	3099	1743	3564	4091	4618	262
150	3810	3321	1868	3819	4383	4948	280
160	4064	3542	1992	4073	4676	5278	299
170	4318	3763	2117	4328	4968	5608	318
180	4572	3985	2241	4583	5260	5937	336
190	4826	4206	2366	4837	5552	6267	355
200	5080	4428	2491	5092	5844	6597	374
250	6350	5535	3113	6365	7306	8246	467
300	7620	6641	3736	7638	8767	9896	560

 There is 5% tolerance among these numbers due to optical component variations. BenQ recommends that if you intend to permanently install the projector, you should physically test the projection size and distance using the actual projector before you permanently install it, so as to make allowance for this projector's optical characteristics. This will help you determine the exact mounting position so that it best suits your installation location.

Connection

When connecting a signal source to the projector, be sure to:

1. Turn all equipment off before making any connections.
2. Use the correct signal cables for each source.
3. Ensure the cables are firmly inserted.

In the connections shown below, some cables may not be included with the projector (see "Shipping contents" on page 8). They are commercially available from electronics stores.

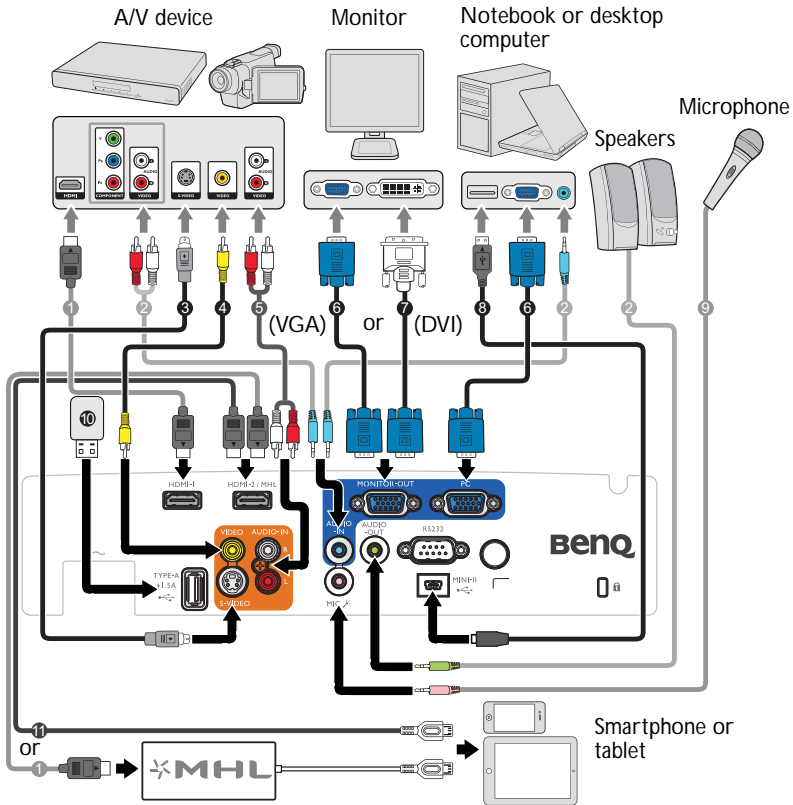





- | | |
|--------------------|----------------------------|
| 1. HDMI cable | 6. VGA cable |
| 2. Audio cable | 7. VGA to DVI-A cable |
| 3. S-Video cable | 8. USB cable |
| 4. Video cable | 9. Microphone |
| 5. Audio L/R cable | 10. Type-A port power 1.5A |
| | 11. HDMI-Micro USB cable |

Many notebooks do not turn on their external video ports when connected to a projector. Usually a key combo like FN + F3 or CRT/LCD key turns the external display on/off. Locate a function key labeled CRT/LCD or a function key with a monitor symbol on the notebook. Press

FN and the labeled function key simultaneously. Refer to your notebook's documentation to find your notebook's key combination.

Connecting video source devices

You need only connect the projector to a video source device using just one of the connecting methods, however each provides a different level of video quality. The method you choose will most likely depend upon the availability of matching terminals on both the projector and the video source device as described below:

Terminal name	Terminal appearance	Picture quality
HDMI		Best
Component Video		Better
S-Video		Good
Video		Normal

Connecting audio

The projector has one built-in mono speaker which are designed to provide basic audio functionality accompanying data presentations for business purposes only. They are not designed for, nor intended for stereo audio reproduction use as might be expected in home theater or home cinema applications. Any stereo audio input (if provided), is mixed into a common mono audio output through the projector speaker.

The built-in speaker will be muted when the **AUDIO OUT** jack is connected.

-  • The projector is only capable of playing mixed mono audio, even if a stereo audio input is connected. See "[Connecting audio](#)" on page 24 for details.
- If the selected video image is not displayed after the projector is turned on and the correct video source has been selected, check that the video source device is turned on and operating correctly. Also check that the signal cables have been connected correctly.

Playing sound through the projector

You can make use of the projector (mixed mono) speaker in your presentations, and also connect separate amplified speakers to the AUDIO OUT socket of the projector.

If you have a separate sound system, you will most likely want to connect the audio output of your Video source device to that sound system, instead of to the mono audio projector.

Once connected, the audio can be controlled by the projector On-Screen Display (OSD) menus.

The table below describes the connection methods for different devices, and where the sound is from.

Device	PC	Component/ S Video/Video	HDMI-1/ HDMI-2/MHL
Audio input port	AUDIO IN (mini jack)	AUDIO (L/R)	HDMI
The projector can play the sound from...	AUDIO IN (mini jack)	AUDIO (L/R)	HDMI
Audio output port	AUDIO OUT	AUDIO OUT	AUDIO OUT
The selected input signal determines which sound will be played by the projector speaker, and which sound will be output from the projector when AUDIO OUT is connected. If you select the PC signal, the projector can play the sound received from AUDIO IN mini jack. If you select the S-VIDEO/VIDEO signal, the projector can play the sound received from AUDIO (L/R).			



Operation

Starting up the projector

1. Remove the lens cap.
2. Plug the power cord into the projector and into a wall socket. Turn on the wall socket switch (where fitted). Check that the **POWER indicator light** on the projector lights orange after power has been applied.

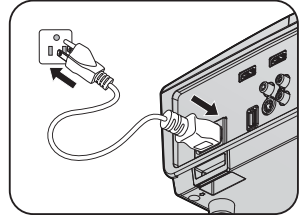
 Please use the original accessories (e.g. power cable) only with the device to avoid possible dangers such as electric shock and fire.



3. Press **POWER** on the projector  or remote control  to start the projector and a start up tone sounds. The **POWER indicator light** flashes green and stays green when the projector is on.

The start up procedure takes about 30 seconds. In the later stage of start up, a startup logo is projected.

(If necessary) Rotate the focus ring to adjust the image clearness.

To turn off the ring tone, see "[Turning off the Power on/off ring tone](#)" on page 44 for details.

 If the projector is still hot from previous activity, it will run the cooling fan for approximately 90 seconds before energizing the lamp.

4. To use the OSD menus, please set them to your familiar language first.
5. If you are prompted for a password, press the arrow keys to enter a six digit password. See "[Utilizing the password function](#)" on page 31 for details.
6. Switch all of the connected equipment on.
7. The projector will start to search for input signals. The current input signal being scanned displays in the upper left corner of the screen. If the projector doesn't detect a valid signal, the message '**No Signal**' will continue displaying until an input signal is found.

Please select language			
English	한국어	Hrvatski	ភាសាខ្មែរ
Frangais	Svenska	Română	
Deutsch	Nederlands	Norsk	
Italiano	Türkçe	Dansk	
Español	Čeština	Български	
Русский	Português	suomi	
繁體中文	ไทย	Indonesian	
簡體中文	Polski	Ελληνικό	
日本語	Magyar	ქართული	

Press Enter to confirm, Exit to leave

You can also press **SOURCE** on the projector or remote control to select your desired input signal. See "[Switching input signal](#)" on page 34 for details.

 If the frequency/resolution of the input signal exceeds the projector's operating range, you will see the message 'Out of Range' displayed on a blank screen. Please change to an input signal which is compatible with the projector's resolution or set the input signal to a lower setting. See "[Timing chart](#)" on page 69 for details.

 To maintain the lamp life, once you turn the projector on, wait at least 5 minutes before turning it off.

Adjusting the projected image

Adjusting the projection angle

The projector is equipped with 1 front adjuster foot and 1 rear adjuster foot. These adjusters change the image height and projection angle. To adjust the projector:

1. Screw the front adjuster foot. Once the image is positioned where you want it.
2. Screw the rear adjuster foot to fine tune the horizontal angle.

To retract the foot. Screw the front and rear adjuster foot in a reverse direction.

If the projector is not placed on a flat surface or the screen and the projector are not perpendicular to each other, the projected image becomes trapezoidal. To correct this situation, see ["Correcting 2D Keystone" on page 28](#) for details.

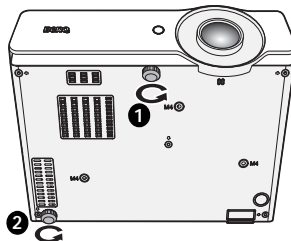

- ⚠ • Do not look into the lens while the lamp is on. The strong light from the lamp may cause damage to your eyes.
- Be careful when you press the adjuster button as it is close to the exhaust vent where hot air comes from.

Auto-adjusting the image

In some cases, you may need to optimize the picture quality. To do this, press **AUTO** on the projector or remote control. Within 3 seconds, the built-in Intelligent Auto Adjustment function will re-adjust the values of Frequency and Clock to provide the best picture quality.

The current source information will be displayed in the upper left corner of the screen for 3 seconds.

- ☞ • The screen will be blank while AUTO is functioning.
- This function is only available when PC signal (analog RGB) is selected.

Fine-tuning the image size and clarity

1. Adjust the projected image to the size that you need using the ZOOM ring.

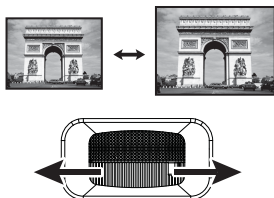

2. Sharpen the image by rotating the FOCUS ring.

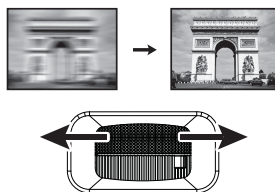

Correcting 2D Keystone

2D Keystone function enables a wider projector installation area compared to conventional projectors with limited positioning in front of the screen.

To correct this, you will need to manually correct it following one of these steps.

- Using the projector or remote control

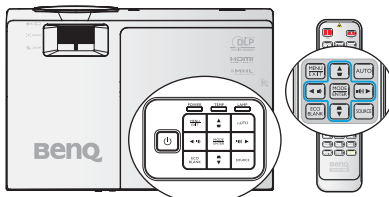

Press **▼/▲** on the projector or remote control to display the 2D Keystone page. Press **▲/▼** to adjust vertical values from -30 to 30. Press **◀/▶** to adjust horizontal values from -30 to 30.



- Using the OSD menu
 - Press **MENU/EXIT** and then press **◀/▶** until the **Display** menu is highlighted.
 - Press **▼** to highlight **2D Keystone** and press **MODE/ENTER**. The **2D Keystone** page displays.
 - Press **▲, ▼, ◀, ▶** to adjust the keystone values.



- Using the **QUICK INSTALL** key
 - Press **QUICK INSTALL** on the remote control.



- Press **▼** to highlight **2D Keystone** and press **MODE/ENTER**. The **2D Keystone** page displays.
- Press **▲, ▼, ◀, ▶** to adjust the keystone values.

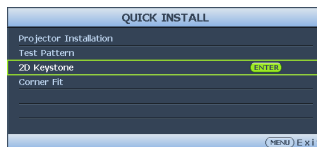

Correcting Corner Fit

Manually adjust four corners of the image by setting the horizontal and vertical values.

- Using the OSD menu
1. Press **MENU/EXIT** and then press **◀/▶** until the **Display** menu is highlighted.
 2. Press **▼** to highlight **Corner Fit** and press **MODE/ENTER**. The **Corner Fit** page displays.
 3. Press **▲, ▼, ◀, ▶** to select one of the four corners and press **MODE/ENTER**.
 4. Press **▲/▼** to adjust vertical values from 0 to 60.
 5. Press **◀/▶** to adjust horizontal values from 0 to 60.

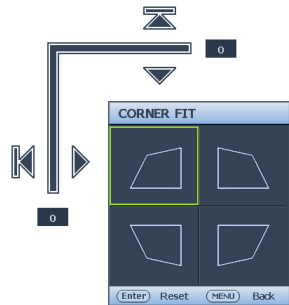
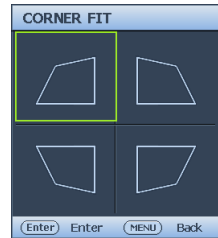

Using the menus

The projector is equipped with On-Screen Display (OSD) menus for making various adjustments and settings.

Below is the overview of the OSD menu.



To use the OSD menus, please set them to your familiar language first.

1. Press **MODE/ENTER** on the projector or remote control to turn the OSD menu on.
3. Press **▼** to highlight **Language** and press **◀/▶** to select a preferred language.



2. Use **◀/▶** to highlight the **System Setup : Basic** menu.
4. Press **MODE/ENTER** twice* on the projector or remote control to leave and save the settings.

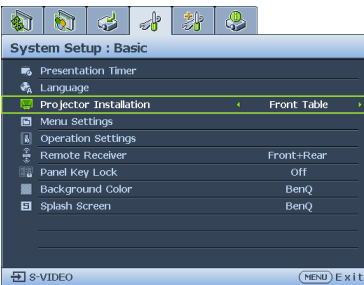

*The first press leads you back to the main menu and the second press closes the OSD menu.

Securing the projector

Using a security cable lock

The projector has to be installed in a safe place to prevent theft. Otherwise, purchase a lock, such as a Kensington lock, to secure the projector. You can locate a Kensington lock slot on the left side of the projector. See "[Kensington anti-theft lock slot](#)" on page 9 for details.

A Kensington security cable lock is usually a combination of key(s) and a lock. Refer to the lock's documentation for finding out how to use it.

Utilizing the password function

For security purposes and to help prevent unauthorized use, the projector includes an option for setting up password security. The password can be set through the On-Screen Display (OSD) menu.

 **WARNING:** You will be inconvenienced if you activate the power-on lock functionality and subsequently forget the password. Print out this manual (if necessary) and write the password you used in this manual, and keep the manual in a safe place for later recall.

Setting a password

 Once a password has been set, the projector cannot be used unless the correct password is entered every time the projector is started.

1. Open the OSD menu and go to the **System Setup: Advanced > Security Settings** menu. Press **MODE/ENTER**. The **Security Settings** page displays.
2. Highlight **Change Security Settings** and press **MODE/ENTER**.
3. As pictured to the right, the four arrow keys (**▲**, **▼**, **◀**, **▶**) respectively represent 4 digits (1, 2, 3, 4). According to the password you desire to set, press the arrow keys to enter six digits for the password.
4. Confirm the new password by re-entering the new password.
Once the password is set, the OSD menu returns to the **Security Settings** page.
5. To activate the **Power on Lock** function, press **▲/▼** to highlight **Power on Lock** and press **◀/▶** to select **On**.

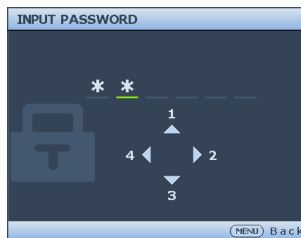

 The digits being input will display as asterisks on-screen. Write your selected password down here in this manual in advance or right after the password is entered so that it is available to you should you ever forget it.

Password: _ _ _ _ _

Keep this manual in a safe place.

6. To leave the OSD menu, press **MENU/EXIT**.

If you forget the password

If the password function is activated, you will be asked to enter the six-digit password every time you turn on the projector. If you enter the wrong password, the password error message as pictured to the right displays lasting for three seconds, and the message **'INPUT PASSWORD'** follows. You can retry by entering another six-digit password, or if you did not record the password in this manual, and you absolutely do not remember it, you can use the password recall procedure. See ["Entering the password recall procedure" on page 32](#) for details.

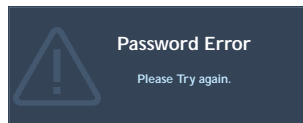

If you enter an incorrect password 5 times in succession, the projector will automatically shut down in a short time.

Entering the password recall procedure

1. Press and hold **AUTO** on the projector or remote control for 3 seconds. The projector will display a coded number on the screen.
2. Write down the number and turn off your projector.
3. Seek help from the local BenQ service center to decode the number. You may be required to provide proof of purchase documentation to verify that you are an authorized user of the projector.

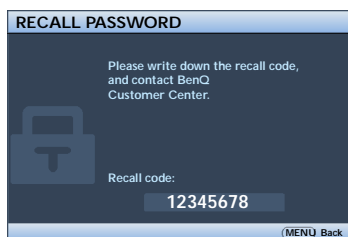

Changing the password

1. Open the OSD menu and go to the **System Setup: Advanced > Security Settings > Change password** menu.
2. Press **MODE/ENTER**. The message '**INPUT CURRENT PASSWORD**' displays.
3. Enter the old password.
 - If the password is correct, another message '**INPUT NEW PASSWORD**' displays.
 - If the password is incorrect, the password error message displays lasting for three seconds, and the message '**INPUT CURRENT PASSWORD**' displays for your retry. You can press **MENU/EXIT** to cancel the change or try another password.
4. Enter a new password.

 The digits being input will display as asterisks on-screen. Write your selected password down here in this manual in advance or right after the password is entered so that it is available to you should you ever forget it.

Password: _ _ _ _ _

Keep this manual in a safe place.

5. Confirm the new password by re-entering the new password.
6. You have successfully assigned a new password to the projector. Remember to enter the new password next time the projector is started.
7. To leave the OSD menu, press **MENU/EXIT**.

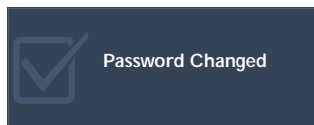

Disabling the password function

To disable password protection, go back to the **System Setup: Advanced > Security Settings > Change Security Settings** menu after opening the OSD menu system. Press **MODE/ENTER**. The message "**INPUT PASSWORD**" appears. Enter the current password.

- i. If the password is correct, the OSD menu returns to the **Security Settings**. Press **▼** highlight **Power On Lock** and press **◀/▶** to select **Off**. You will not have to enter the password next time you turn on the projector.
- ii. If the password is incorrect, the password error message displays lasting for three seconds, and the message '**INPUT PASSWORD**' displays for your retry. You can press **MENU/EXIT** to cancel the change or try another password.

 Though the password function is disabled, you need to keep the old password in hand should you ever need to re-activate the password function by entering the old password.

Switching input signal

The projector can be connected to multiple devices at the same time. However, it can only display one full screen at a time.

Be sure the **Quick Auto Search** function in the **Source** menu is **On** (which is the default of this projector) if you want the projector to automatically search for the signals.

You can also manually cycle through the available input signals.

1. Press **SOURCE** on the projector or press input source directly from the remote control. A source selection bar displays.
2. Press **▲/▼** until your desired signal is selected and press **MODE/ENTER**.
Once detected, the selected source information will display on the screen for seconds. If there is multiple equipment connected to the projector, repeat steps 1-2 to search for another signal.

-  • The brightness level of the projected image will change accordingly when you switch between different input signals. Data (graphic) "PC" presentations using mostly static images are generally brighter than "Video" using mostly moving images (movies).
- For best display picture results, you should select and use an input signal which outputs at this resolution. Any other resolutions will be scaled by the projector depending upon the 'aspect ratio' setting, which may cause some image distortion or loss of picture clarity. See ["Selecting the aspect ratio" on page 35](#) for details.

Changing Color Space

In the unlikely event that you connect the projector to a DVD player via the projector's **HDMI** input and the projected picture displays wrong colors, please change the color space.

To do this:

1. Press **MENU/EXIT** and then press **◀/▶** until the **SOURCE** menu is highlighted.
2. Press **▼** to highlight **Color Space Conversion** and press **◀/▶** to select the setting.

-  This function is only available when the HDMI input socket is in use.

Magnifying and searching for details

If you need to find the details on the projected picture, magnify the picture. Use the direction arrow keys for navigating the picture.

- Using the remote control
 1. Press **Digital Zoom+/-** to display the Zoom bar. Press **Digital Zoom+** to magnify the center of the picture. Press the key repeatedly until the picture size is suitable for your need.
 2. Use the directional arrows (**▲**, **▼**, **◀**, **▶**) on the projector or remote control to navigate the picture.
 3. To restore the picture to its original size, press **AUTO**. You can also press **Digital Zoom-**. When the key is pressed again, the picture is further reduced until it is restored to the original size.
- Using the OSD menu
 1. Press **MENU/EXIT** and then press **◀/▶** until the **Display** menu is highlighted.
 2. Press **▼** to highlight **Digital Zoom** and press **MODE/ENTER**. The Zoom bar displays.
 3. Press **▼** on the projector repeatedly to magnify the picture to a desired size.
 4. To navigate the picture, press **MODE/ENTER** to switch to the panning mode and press the directional arrows (**▲**, **▼**, **◀**, **▶**) to navigate the picture.
 5. To reduce size of the picture, press **MODE/ENTER** to switch back to the zoom in/out functionality, and press **AUTO** to restore the picture to its original size. You can also press **▼** repeatedly until it is restored to the original size.

 The picture can only be navigated after the picture is magnified. You can further magnify the picture while searching for details.

Selecting the aspect ratio

The 'aspect ratio' is the ratio of the image width to the image height. Most analog TV and computers are in 4:3 ratio, and digital TV and DVDs are usually in 16:9 ratio.

With the advent of digital signal processing, digital display devices like this projector can dynamically stretch and scale the image output to a different aspect than that of the image input signal.

To change the projected image ratio (no matter what aspect the source is):

- Using the remote control
 1. Press **Aspect** to show the current setting.
 2. Press **Aspect** repeatedly to select an aspect ratio to suit the format of the video signal and your display requirements.
- Using the OSD menu
 1. Press **MENU/EXIT** and then press **◀/▶** until the **Display** menu is highlighted.
 2. Press **▼** to highlight **Aspect Ratio**.
 3. Press **◀/▶** to select an aspect ratio to suit the format of the video signal and your display requirements.

About the aspect ratio

 In the pictures below, the black portions are inactive areas and the white portions are active areas. OSD menus can be displayed on those unused black areas.

1. **Auto:** Scales an image proportionally to fit the projector's native resolution in its horizontal width. This is suitable for the incoming image which is neither in 4:3 nor 16:9 and you want to make most use of the screen without altering the image's aspect ratio.

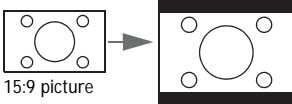

2. **Real:** The image is projected at its original resolution, and resized to fit within the display area. For input signals with lower resolutions, the projected image will display smaller than if resized to full screen. You could adjust the zoom setting or move the projector away from the screen to increase the image size if necessary. You may also need to refocus the projector after making these adjustments.

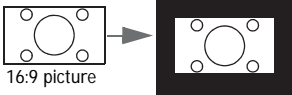

3. **4:3:** Scales an image so that it is displayed in the center of the screen with a 4:3 aspect ratio. This is most suitable for 4:3 images like computer monitors, standard definition TV and 4:3 images aspect DVD movies, as it displays them without aspect alteration.

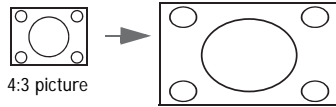

4. **16:9:** Scales an image so that it is displayed in the center of the screen with a 16:9 aspect ratio. This is most suitable for images which are already in a 16:9 aspect, like high definition TV, as it displays them without aspect alteration.

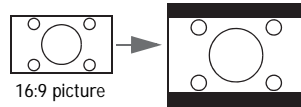

5. **16:10:** Scales an image so that it is displayed in the center of the screen with a 16:10 aspect ratio. This is most suitable for images which are already in a 16:10 aspect, as it displays them without aspect alteration.

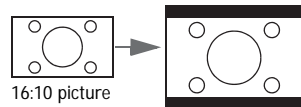

Optimizing the image

Using Wall Color

In the situation where you are projecting onto a colored surface such as a painted wall which may not be white, the **Wall Color** feature can help correct the projected picture's color to prevent possible color difference between the source and projected pictures.

To use this function, go to the **Display > Wall Color** menu and press ◀/▶ to select a color which is the closest to the color of the projection surface. There are several precalibrated colors to choose from: **Light Yellow**, **Pink**, **Light Green**, **Blue**, and **Blackboard**.

Selecting a picture mode

The projector is preset with several predefined picture modes so that you can choose one to suit your operating environment and input signal picture type.

To select an operation mode that suits your need, you can follow one of the following steps.

- Press **MODE/ENTER** on the projector repeatedly until your desired mode is selected.
- Go to the **Picture > Picture Mode** menu and press ◀/▶ to select a desired mode.
 1. **Bright mode**: Maximizes the brightness of the projected image. This mode is suitable for environments where extra-high brightness is required, such as using the projector in well lit rooms.
 2. **Presentation mode**: Is designed for presentation. The brightness is emphasized in this mode to match PC and notebook coloring..
 3. **sRGB mode**: Maximizes the purity of RGB colors to provide true-to-life images regardless of brightness setting. It is most suitable for viewing photos taken with an sRGB compatible and properly calibrated camera, and for viewing PC graphic and drawing applications such as AutoCAD.
 4. **Cinema mode**: Is appropriate for playing colorful movies, video clips from digital cameras or DVs through the PC input for best viewing in a blackened (dimly lit) environment.
 5. **3D mode**: Is appropriate for playing 3D images and 3D video clips.
 6. **User 1/User 2 mode**: Recalls the settings customized based on the current available picture modes. See "[Setting the User 1/User 2 mode](#)" on page 38 for details.

Setting the User 1/User 2 mode

There are two user-definable modes if the current available picture modes are not suitable for your need. You can use one of the picture modes (except the **User 1/User 2**) as a starting point and customize the settings.

1. Press **MENU/EXIT** to open the On-Screen Display (OSD) menu.
2. Go to the **Picture > Picture Mode** menu.
3. Press **◀/▶** to select **User 1 to User 2**.
4. Press **▼** to highlight **Reference Mode**.

 This function is only available when User 1 or User 2 mode is selected up in the Picture Mode sub-menu item.

5. Press **◀/▶** to select a picture mode that is closest to your need.
6. Press **▼** to select a sub-menu item to be changed and adjust the value with **◀/▶**.
See "[Fine-tuning the image quality in user modes](#)" below for details.

Fine-tuning the image quality in user modes

According to the detected signal type, and selected picture mode, some of the functions listed below may not be available. Base on your need, you can make adjustments to these functions by highlighting them and press **◀/▶** on the projector or remote control.

Adjusting Brightness

The higher the value, the brighter the image. And lower the setting, darker the image. Adjust this control so the black areas of the image appear just as black and that detail in the dark areas is visible.



Adjusting Contrast

The higher the value, the greater the contrast. Use this to set the peak white level after you have previously adjusted the **Brightness** setting to suit your selected input and viewing environment.



Adjusting Color

Lower setting produces less saturated colors. If the setting is too high, colors on the image will be overpowering, which makes the image unrealistic.

Adjusting Tint

The higher the value, the more reddish the picture becomes. The lower the value, the more greenish the picture becomes.

Adjusting Sharpness

The higher the value, the sharper the picture becomes. The lower the value, the softer the picture becomes.

Adjusting Brilliant Color

This feature utilizes a new color-processing algorithm and system level enhancements to enable higher brightness while providing truer, more vibrant colors in picture. It enables a greater than 50% brightness increase in mid-tone images, which are common in video and natural scenes, so the projector reproduces images in realistic and true colors. If you prefer images with that quality, select **On**. If you don't need it, select **Off**.

When **Off** is selected, the **Color Temperature** function is not available.

Selecting a Color Temperature

The options available for color temperature* settings vary according to the signal type selected.

1. **Cooler:** makes the image appear bluish white.
2. **Normal:** Maintains normal colorings for white.
3. **Warm:** Makes images appear reddish white.

*About color temperatures:

There are many different shades that are considered to be "white" for various purposes. One of the common methods of representing white color is known as the "color temperature". A white color with a low color temperature appears to be reddish white. A white color with a high color temperature appears to have more blue in it.

Setting a preferred color temperature

To set a preferred color temperature:

1. Highlight **Color Temperature** and select **Warm**, **Normal** or **Cool** by pressing ◀/▶ on the projector or remote control.
2. Press ▼ to highlight **Color Temperature Fine Tuning** and press **MODE/ENTER**. The Color Temperature Fine Tuning page appears.
3. Press ▲/▼ to highlight the item you want to change and adjust the values by pressing ◀/▶.
 - **R Gain/G Gain/B Gain:** Adjusts the contrast levels of Red, Green, and Blue.
 - **R Offset/G Offset/B Offset:** Adjusts the brightness levels of Red, Green, and Blue.
4. Press **MENU/EXIT** to exit and save the settings.

3D Color Management

In most installation situations, color management will not be necessary, such as in classroom, meeting room, or lounge room situations where lights remain on, or where building external windows allow daylight into the room.

Only in permanent installations with controlled lighting levels such as boardrooms, lecture theaters, or home theaters, should color management be considered. Color management provides fine color control adjustment to allow for more accurate color reproduction, should you require it.

Proper color management can only be achieved under controlled and reproducible viewing conditions. You will need to use a colorimeter (color light meter), and provide a set of suitable source images to measure color reproduction. These tools are not provided with the projector, however, your projector supplier should be able to provide you with suitable guidance, or even an experienced professional installer.

The Color Management provides six sets (RGBCMY) of colors to be adjusted. When you select each color, you can independently adjust its range and saturation according to your preference.

If you have purchased a test disc which contains various color test patterns and can be used to test the color presentation on monitors, TVs, projectors, etc. You can project any image from the disc on the screen and enter the **3D Color Management** menu to make adjustments.

To adjust the settings:

1. Go to the **Picture** menu and highlight **3D Color Management**.
2. Press **MODE/ENTER** and the **3D Color Management** page displays.
3. Highlight **Primary color** and press ◀/▶ to select a color from among Red, Green, Blue, Cyan, Magenta and Yellow.
4. Press ▼ to highlight **Hue** and press ◀/▶ to select its range. Increase in the range will include colors consisted of more proportions of its two adjacent colors.

Please refer to the illustration to the right for how the colors relate to each other.

For example, if you select Red and set its range at 0, only pure red in the projected picture will be selected. Increasing its range will include red close to yellow and red close to magenta.

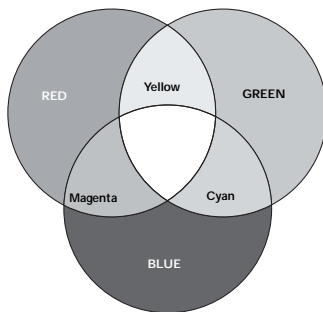

5. Press ▼ to highlight **Saturation** and adjust its values to your preference by pressing ◀/▶. Every adjustment made will reflect to the image immediately.

For example, if you select Red and set its value at 0, only the saturation of pure red will be affected.

 **Saturation is the amount of that color in a video picture. Lower settings produce less saturated colors; a setting of “0” removes that color from the image entirely. If the saturation is too high, that color will be overpowering and unrealistic.**

6. Press ▼ to highlight **Gain** and adjust its values to your preference by pressing ◀/▶. The contrast level of the primary color you select will be affected. Every adjustment made will reflect to the image immediately.
7. Repeat steps 3 to 6 for other color adjustments.
8. Make sure you have made all of the desired adjustments.
9. Press **MENU/EXIT** to exit and save the settings.

Resetting current or all picture modes

1. Go to the **Picture** menu and highlight **Reset Picture Settings**.
2. Press **MODE/ENTER** and press ▲/▼ to select **Current** or **All**.
 - **Current**: returns current picture mode to the factory preset settings.
 - **All**: returns all settings, except **User 1/User 2** in the **Picture** menu to the factory preset settings.

Setting the presentation timer

Presentation timer can indicate the presentation time on the screen to help you achieve better time management when giving presentations. Follow these steps to utilize this function:

1. Go to the **System Setup: Basic > Presentation Timer** menu and press **MODE/ENTER** to display the **Presentation Timer** page.
2. Highlight **Timer Period** and decide the time period by pressing **◀/▶**. The length of time can be set from 1 to 5 minutes in 1-minute increments and 5 to 240 minutes in 5-minute increments.

 If the timer is already on, the timer will restart whenever the **Timer Period** is reset.

3. Press **▼** to highlight **Timer Display** and choose if you want the timer to show up on the screen by pressing **◀/▶**.

Selection	Description
Always	Displays the timer on screen throughout the presentation time.
3 min/2 min/1 min	Displays the timer on screen in the last 3/2/1 minute(s).
Never	Hides the timer throughout the presentation time.

4. Press **▼** to highlight **Timer Position** and set the timer position by pressing **◀/▶**.
5. Press **▼** to highlight **Timer Counting Direction** and select your desired counting direction by pressing **◀/▶**.

Selection	Description
Count Up	Increases from 0 to the preset time.
Count Down	Decreases from the preset time to 0.

6. Press **▼** to highlight **Sound Reminder** and decide if you want to activate sound reminder by pressing **◀/▶**. If you select **On**, a double beep sound will be heard at the last 30 seconds of counting down/up, and a triple beep sound will be produced when the timer is up.
7. To activate the presentation timer, press **▼** and press **◀/▶** to highlight **On** and press **MODE/ENTER**.
8. A confirmation message appears. Highlight **Yes** and press **MODE/ENTER** on the projector or remote control to confirm. You will see the message "**Timer is On**" appearing on the screen. The timer starts counting when the timer is on.

To cancel the timer, perform the following steps:

1. Go to the **System Setup: Basic > Presentation Timer** menu and highlight **Off**. Press **MODE/ENTER**. A confirmation message appears.
2. Highlight **Yes** and press **MODE/ENTER** to confirm. You will see the message "**Timer is Off**" appearing on the screen.

Remote paging operations

Connect the projector to your PC or notebook with a USB cable prior to using the paging function. See "[Connection](#)" on page 23 for details.

You can operate your display software program (on a connected PC) which responds to page up/down commands (like Microsoft PowerPoint) by pressing **PAGE +/PAGE -** on the remote control.

If remote paging function doesn't work, check if the USB connection is correctly made and the mouse driver on your computer is updated to the latest version.

 The remote paging function cannot work with Microsoft® Windows® 98 operating system. Windows® XP or higher operating systems are recommended.

Freezing the image

Press **FREEZE** on the remote control to freeze the image. The word '**FREEZE**' will appear on the screen. To release the function, press any key on the projector or remote control.

 If your remote control has the following keys, please note that they cannot be pressed to release the function: **LASER, #2, #5, PAGE +/PAGE -**.

Even if an image is frozen on the screen, the pictures are running on the video or other device. If the connected devices have active audio output, you will still hear the audio even though the image is frozen on screen.

Hiding the image

In order to draw the audience's full attention to the presenter, you can use **ECO BLANK** on the projector or **ECO BLANK** on the remote control to hide the screen image. When the function is activated with an audio input connected, the audio can still heard.

You can set the blank time in the **System Setup: Basic > Operating Settings > Blank Timer** menu to let the projector return the image automatically after a period of time when there is no action taken on the blank screen. The length of time can be set from 5 to 30 minutes in 5-minute increments.

If the preset time spans are not suitable for your presentation, select **Disable**.

No matter **Blank Timer** is activated or disabled, you can press most of the keys on the projector or remote control to restore the picture.

 • Do not block the projection lens from projecting as this could cause the blocking object to become heated and deformed or even cause a fire.

Locking control keys

With the control keys on the projector locked, you can prevent your projector settings from being changed accidentally (by children, for example). When the **Panel Key Lock** is on, no control keys on the projector will operate except  **POWER**.

1. Go to the **System Setup: Basic > Panel Key Lock** menu, and select **On** by pressing **◀/▶** on the projector or remote control. A confirmation message appears.
2. Highlight **Yes** and press **MODE/ENTER** to confirm.

To release panel key lock, use the remote control to enter the **System Setup: Basic > Panel Key Lock** menu and press **◀/▶** to select **Off**.



• **Keys on the remote control are still active when panel key lock is enabled.**

- If you press  **POWER** to turn off the projector without disabling panel key lock, the projector will still be in locked status the next time it is turned on.

Operating in a high altitude environment

We recommend you use the **High Altitude Mode** when your environment is between 1500 m –3000 m above sea level, and temperature is between 0°C–30°C.



Do not use the High Altitude Mode if your altitude is between 0 m and 1500 m and temperature is between 0°C and 35°C. The projector will be over cooled, if you turn the mode on under such a condition.

To activate the **High Altitude Mode**:

1. Press **MENU/EXIT** and then press **◀/▶** until the **System Setup: Advanced** menu is highlighted.
2. Press **▼** to highlight **High Altitude Mode** and press **◀/▶** to select **On**. A confirmation message displays.
3. Highlight **Yes** and press **MODE/ENTER**.

Operation under "**High Altitude Mode**" may cause a higher decibel operating noise level because of increased fan speed necessary to improve overall system cooling and performance.

If you use this projector under other extreme conditions excluding the above, it may display auto shut-down symptoms, which is designed to protect your projector from over-heating. In cases like this, you should switch to High Altitude mode to solve these symptoms. However, this is not to state that this projector can operate under any and all harsh or extreme conditions.

Adjusting the sound

The sound adjustments made as below will have an effect on the projector speakers. Be sure you have made a correct connection to the projector audio input. See "[Connection](#)" on page 23 for how the audio input is connected.

INPUT SOURCE	AUDIO IN	AUDIO OUT
PC	mini jack	mini jack
HDMI-1, HDMI-2/MHL	HDMI	mini jack
VIDEO	RCA	mini jack
S-VIDEO	RCA	mini jack

Muting the sound

To temporarily turn off the sound,

- Using the remote control

Press **MUTE** to temporarily turn off the sound. While the sound is off, the screen will display  in the upper right corner of the screen.

To restore the sound, press **MUTE** again.

- Using the OSD menu

1. Press **MENU/EXIT** and then press **◀/▶** until the **System Setup: Advanced** menu is highlighted.
2. Press **▼** to highlight **Audio Settings** and press **MODE/ENTER**. The **Audio Settings** page displays.
3. Highlight **Mute** and press **◀/▶** to select **On**.
4. To restore the sound, repeat steps 1-3 and press **◀/▶** to select **Off**.

Adjusting the sound level

To adjust the sound level,

- Using the remote control

Press **🔊** or **🔊🔊** to select a desired sound level.

- Using the OSD menu

1. Repeat steps 1-2 above.
2. Press **▼** to highlight **Volume** and press **◀/▶** to select a desired sound level.

Microphone Volume

To adjust the microphone sound level, press **MIC/VOL** keys (+/-) on the remote control, or:

1. Repeat steps 1-2 above.
2. Press **▼** to highlight **Microphone Volume** and press **◀/▶** to select a desired sound level.

Turning off the Power on/off ring tone

1. Repeat steps 1-2 above.
2. Press **▼** to highlight **Power on/off ring tone** and press **◀/▶** to select **Off**.

The only way to change Power on/off ring tone is setting On or Off here. Setting the sound mute or changing the sound level will not affect the Power on/off ring tone.

Using the test pattern

The projector is capable of displaying the grid test pattern. It can be used to assist you with the adjustment of image size and focus, ensuring that the projected image is free from distortion.

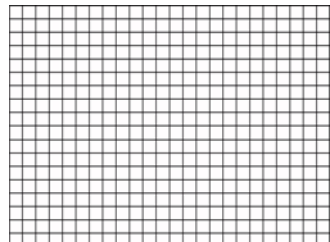

To display the test pattern, open the OSD menu and go to the **System Setup: Advanced > Test Pattern** and press **◀/▶** to select **On**.



Using the teaching templates

The projector provides several preset patterns for various teaching purposes. To activate the pattern:

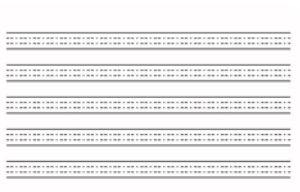
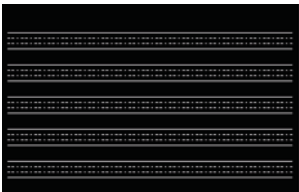
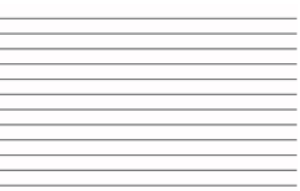
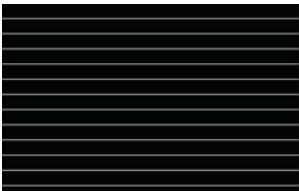
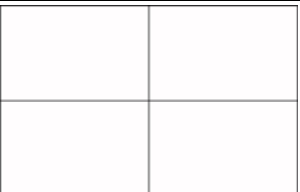
1. Open the OSD menu and go to the **Display > Teaching Template** and press **▲/▼** to select **Blackboard** or **Whiteboard**.
2. Press **◀/▶** to choose the pattern you need.
3. Press **MODE/ENTER** to activate the pattern.

Teaching Template	Whiteboard	Blackboard
Letter Formation		
Worksheet		
Coordinate Chart		

Using the quick install

The projector provides a hot key to set **Projector Installation**, **Test Pattern**, and **Keystone** quickly.

Press **Quick Install** on the remote control and press **▲/▼** to select:

- Projector Installation: See ["Positioning your projector" on page 20](#).
- Test Pattern: See ["Using the test pattern" on page 44](#).
- Keystone: See ["Correcting 2D Keystone" on page 28](#).

Shutting down the projector

1. Press **POWER** or **OFF** and a confirmation message will appear prompting you.
If you don't respond in a few seconds, the message will disappear.
2. Press **POWER** or **OFF** a second time. The **POWER indicator light** flashes orange, the projection lamp shuts down, and the fans will continue to run for approximately 90 seconds to cool down the projector.

 **To protect the lamp, the projector will not respond to any commands during the cooling process. To shorten the cooling time, you can also activate the Quick Cooling function. See "Quick Cooling" on page 54 for details.**

3. Once the cooling process finishes, a "**Power Off Ring Tone**" will be heard. The **POWER indicator light** is a steady orange and fans stop. Disconnect the power cord from the power outlet.

 • To turn off the power ring tone, see "**Turning off the Power on/off ring tone**" on page 44 for details.

- If the projector is not properly shut down, to protect the lamp, when you attempt to re-start the projector, the fans will run for a few minutes to cool down. Press **POWER** or **ON** again to start the projector after the fans stop and the **POWER indicator light** turns orange.
- Lamp life results will vary depending on environmental conditions and usage.

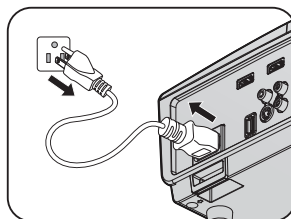

Menu operation

Menu system

Please note that the on-screen display (OSD) menus vary according to the signal type selected.

Main menu	Sub-menu	Options	
1. Display	Wall color	Off/Light Yellow/Pink/Light Green/Blue/Blackboard	
	Aspect Ratio	Auto/Real/4:3/16:9/16:10	
	Auto Keystone	On/Off	
	2D Keystone		
	Corner Fit	Top Left/Top Right/Bottom Left/Bottom Right	
	Position		
	Phase		
	H.size		
	Digital zoom	PC:1.0X~2.0X; Video: 1.0X~1.8X	
	3D	3D mode	Auto/Off/Frame sequential/Frame packing/Top bottom/Side by side
		3D Sync Invert	Disable/Invert
		Save 3D Setting	3D Settings 1/3D Settings 2/3D Settings 3
		Apply 3D Setting	3D Settings 1/3D Settings 2/3D Settings 3
	Teaching Template	Blackboard	Off/Letter Formation/Worksheet/Coordinate Chart
		Whiteboard	Off/Letter Formation/Worksheet/Coordinate Chart

Main menu	Sub-menu	Options	
2. Picture	Picture Mode	Bright/Presentation/sRGB/Cinema/ 3D/User 1/User 2	
	Reference Mode	Bright/Presentation/sRGB/Cinema/ 3D	
	Brightness		
	Contrast		
	Color		
	Tint		
	Sharpness		
	Brilliant Color	On/Off	
	Color Temperature	Cool/Normal/Warm	
	Color Temperature Fine Tuning	R Gain/G Gain/B Gain/ R Offset/G Offset/B Offset	
	3D Color Management	Primary Color	R/G/B/C/M/Y
		Hue	
		Saturation	
		Gain	
Reset picture settings	Current/All/Cancel		
3. Source	Quick Auto Search	On/Off	
	Color Space Conversion	Auto/RGB/YUV	

Main menu	Sub-menu	Options	
4. System Setup: Basic	Presentation Timer	Timer Period	1~240 min
		Timer Display	Always/1 min/2mins/3 mins/Never
		Timer Position	Top-Left/Bottom-Left/ Top-Right/Bottom-Right
		Timer Counting Direction	Count Down/Count up
		Sound Reminder	On/Off
		On/Off	Yes/No
	Language		English / Français / Deutsch / Italiano / Español / Русский / 繁體中文 / 简体中文 / 日本語 / 한국어 / Svenska / Nederlands / Türkçe / Čeština / Português / ភាសាខ្មែរ / Polski / Magyar / Hrvatski / Română / Norsk / Dansk / Български / Suomi / Indonesian / Ελληνικά / العربية / हिन्दी
	Projector Installation		Front Table/Rear Table/Rear Ceiling/Front Ceiling
	Menu Setting	Menu Display Time	5 sec/10 sec/20 sec/30 sec/Always
		Menu Position	Center/Top-Left/Top-Right/ Bottom-Right/Bottom-Left
		Reminder Message	On/Off
	Operation Setting	Direct Power On	On/Off
		Signal Power On	On/Off
		Auto Power Off	Disable/3 mins/10 mins/15 mins/ 20 mins/25 mins/30 mins
		Quick Cooling	On/Off
		Instant Restart	On/Off
Blank Timer		Disable/5 mins/10 mins/ 15 mins/20 mins/25 mins/ 30 mins	
Sleep Timer		Disable/30 mins/1 hr/2 hrs/3hrs/ 4hrs/8 hrs/12hrs	
Remote Receiver		Front+Rear/Front/Rear	
Panel Key Lock	On/Off		
Background Color	BenQ/Black/Blue/Purple		
Splash Screen	BenQ/Black/Blue		



Main menu	Sub-menu	Options	
5. System Setup: Advanced	High Altitude Mode	On/Off	
	Audio Settings	Mute	On/Off
		Volume	
		Microphone	
		Volume	
	Lamp Settings	Power on/off Ring	On/Off
		Lamp Mode	Normal/Economic/SmartEco
		Reset Lamp Timer	Reset/Cancel
	Security Setting	Lamp Timer	
		Change Password	
		Change Security Settings	
		Power On Lock	On/Off
	Baud Rate		2400/4800/9600/14400/19200/ 38400/57600/115200
	Test Pattern		On/Off
	Closed Caption	Closed Caption Enable	On/Off
		Caption Version	CC1/CC2/CC3/CC4
	Standby Settings	Microphone	On/Off
		Monitor Out	On/Off
		Audio Pass Through	Off/Audio in/Audio L/R/HDMI 1/ HDMI 2/MHL
	Reset All Settings		Reset / Cancel
6. Information	Current System Status	<ul style="list-style-type: none"> • Source • Picture Mode • Lamp Mode • Resolution • 3D Format • Color System • Lamp Usage Time • Firmware Version 	

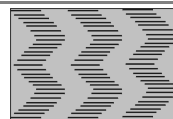

Note that the menu items are available when the projector detects at least one valid signal. If there is no equipment connected to the projector or no signal detected, limited menu items are accessible.

Description of each menu

		FUNCTION	DESCRIPTION
1. Display menu	Wall color		Corrects the projected picture's color when the projection surface is not white. See "Using Wall Color" on page 37 for details.
	Aspect Ratio		There are several options to set the image's aspect ratio depending on your input signal source. See "Selecting the aspect ratio" on page 35 for details.
	Auto Keystone		Corrects vertical keystone of the image automatically.
	2D Keystone		Adjusts the shape of the projected image to ensure straight lines on all four corners. See "Correcting 2D Keystone" on page 28 for details.
	Corner Fit		Adjusts the shape of the projected image to ensure a specific corner is straight. See "Correcting Corner Fit" on page 29 for details.
	Position		Displays the position adjustment page. To move the projected image, use the directional arrow keys. The values shown on the lower position of the page change with every key press you made until they reach their maximum or minimum. This function is only available when a PC signal (analog RGB) is selected.
	Phase		Adjusts the clock phase to reduce image distortion. This function is only available when a PC signal (analog RGB) is selected.
	H.size		Adjusts the horizontal width of the image. This function is only available when a PC signal (analog RGB) is selected.
	Digital zoom		Magnifies or reduces the projected image. See "Magnifying and searching for details" on page 35 for details.





FUNCTION	DESCRIPTION
<p style="writing-mode: vertical-rl; transform: rotate(180deg);">1. Display menu</p> <p style="text-align: center;">3D</p>	<p>This projector features a 3D function which enables you to enjoy the 3D movies, videos, and sporting events in a more realistic way by presenting the depth of the images. You need to wear a pair of 3D glasses to view the 3D images.</p> <p>3D Mode</p> <p>The default setting is Auto and the projector automatically chooses an appropriate 3D format when detecting 3D contents. If the projector cannot recognize the 3D format, press ◀/▶ to choose a 3D mode.</p> <p> When the 3D function is on:</p> <ul style="list-style-type: none"> •The brightness level of the projected image will decrease. •The following settings cannot be adjusted: Picture Mode, Reference Mode. •The Keystone can only be adjusted within limited degrees. <p>3D Sync Invert</p> <p>When you discover the inversion of the image depth, enable this function to correct the problem.</p> <p>Save 3D Settings</p> <p>When you have successfully displayed the 3D contents after making the appropriate adjustments, you can enable this function and choose a set of 3D settings to memorize current 3D settings.</p> <p>Apply 3D Settings</p> <p>After the 3D settings are saved, you can decide if you would like to apply them by choosing a set of 3D settings that you have saved. Once applied, the projector will automatically play the incoming 3D contents if it matches the 3D settings saved.</p> <p> Only the set(s) of 3D settings with memorized data is available.</p>
<p>Teaching Template</p>	<p>See "Using the teaching templates" on page 45 for details.</p>

		FUNCTION	DESCRIPTION
2. Picture menu	Picture Mode		Pre-defined picture modes are provided so you can optimize your projector image set-up to suit your program type. See "Selecting a picture mode" on page 37 for details.
	Reference Mode		Selects a picture mode that most suits your need for the image quality and further fine-tune the image based on the selections listed on the same page below. See "Setting the User 1/User 2 mode" on page 38 for details.
	Brightness		Adjusts the brightness of the image. See "Adjusting Brightness" on page 38 for details.
	Contrast		Adjusts the degree of difference between dark and light in the image. See "Adjusting Contrast" on page 38 for details.
	Color		Adjusts the color saturation level -- the amount of each color in a video image. See "Adjusting Color" on page 38 for details.  The function is only available when Video or S-Video with NTSC system is selected.
	Tint		Adjusts the red and green color tones of the image. See "Adjusting Tint" on page 38 for details.  The function is only available when Video or S-Video with NTSC system is selected.
	Sharpness		Adjusts the image to make it look sharper or softer. See "Adjusting Sharpness" on page 38 for details.  The function is only available when Video or S-Video with NTSC system is selected.
	Brilliant Color		Adjusts white peaking while maintaining correct color presentation. See "Adjusting Brilliant Color" on page 38 for details.
	Color Temperature		See "Selecting a Color Temperature" on page 39 for details.
	Color Temperature Fine Tuning		See "Setting a preferred color temperature" on page 39 for details.
	3D Color Management		See "3D Color Management" on page 39 for details.
Reset picture settings		See "Resetting current or all picture modes" on page 40 for details.	
3. Source menu	Quick Auto Search		See "Switching input signal" on page 34 for details.
	Color Space Conversion		See "Changing Color Space" on page 34 for details.

FUNCTION	DESCRIPTION
Presentation Timer	Reminds the presenter to finish the presentation within a certain time frame. See "Setting the presentation timer" on page 41 for details.
Language	Sets the language for the On-Screen Display (OSD) menus. See "Using the menus" on page 30 for details.
Projector Installation	The projector can be installed on a ceiling or behind a screen, or with one or more mirrors. See "Choosing a location" on page 20 for details.
Menu Setting	Menu display time Sets the length of time the OSD will remain active after your last key press. The range is from 5 to 30 seconds in 5-second increments.
	Menu Position Sets the On-Screen Display (OSD) menu position. Reminder Message Selecting On allows the projector to remind you to clean the filter.
Operation Setting	Direct Power On Powers projector on automatically when the power cable is connected.
	Signal Power On Sets whether to turn the projector directly on without pressing POWER or ON when the projector is in standby mode and the signal is feed through the VGA cable.
	Auto Power Off Allows the projector to turn off automatically if no input signal is detected after a set period of time. See "Setting Auto Power Off" on page 60 for details.
	Quick Cooling Enables or disables the Quick Cooling function. Selecting On enables the function and the projector cooling time will be shortened from a normal 90 second duration to approximately 2 seconds.  If you attempt to restart the projector right after the quick cooling process, it may not be turned on successfully and will rerun its cooling fans.
	Instant Restart Selecting On enables you to restart the projector immediately within 90 seconds after turning it off.
	Blank Timer Sets the image blank time when the Blank feature is activated, once elapsed the image will return to the screen. See "Hiding the image" on page 42 for details. Sleep Timer Sets the auto-shutdown timer. The timer can be set to a value between 30 minutes and 12 hours.

	FUNCTION	DESCRIPTION
4. System Setup: Basic menu	Remote Receiver	Sets the preferred remote receiver (Front and Rear) allowing the projector to accept signals from the remote control.
	Panel Key Lock	Disables or enables all panel key functions except POWER on the projector and keys on the remote control. See " Locking control keys " on page 43 for details.
	Background Color	Selects background appearance when there is no signal.
	Splash Screen	Allows you to select which logo screen will appear during projector start-up
5. System Setup: Advanced menu	High Altitude Mode	A mode for operation in high altitude areas. See " Operating in a high altitude environment " on page 43 for details.
	Audio Settings	See " Adjusting the sound " on page 43 for details.
		Mute Sets the mute function.
		Volume Adjusts the audio volume level.
		Microphone volume Adjusts the microphone sound level.
	Power on/off Ring Tone Sets the power on/off ring tone.	
Lamp Settings	Lamp Mode See " Setting Lamp mode as Economic or SmartEco " on page 59 for details.	
	Reset lamp timer See " Resetting the lamp timer " on page 64 for details.	
	Lamp Timer See " Getting to know the lamp hour " on page 59 for details on how the total lamp hour is calculated.	
Security Setting	Change password You will be asked to enter the current password before changing to a new one. See " Utilizing the password function " on page 31 for details.	
	Change Security Settings	
	Power On Lock When Power On Lock is activated, you will be asked to enter the current password before powering on the projector. If you enter incorrect password 5 times in succession, the projector will automatically shut down in a short time.	

		FUNCTION	DESCRIPTION
5: System Setup: Advanced menu		Baud Rate	Selects a baud rate that is identical with your computer's so that you can connect the projector using a suitable RS-232 cable and update or download the projector's firmware. This function is intended for qualified service personnel.
		Test Pattern	Selecting On enables the function and the projector displays the grid test pattern. It helps you adjust the image size and focus and check that the projected image is free from distortion.
		Closed Caption	<p>Closed Caption Enable Activates the function by selecting On when the selected input signal carries closed captions.</p> <ul style="list-style-type: none"> • Captions: An on-screen display of the dialogue, narration, and sound effects of TV programs and videos that are closed captioned (usually marked as "CC" in TV listings). <p>Caption Version Selects a preferred closed captioning mode. To view captions, select CC1, CC2, CC3, or CC4 (CC1 displays captions in the primary language in your area).</p>
		Standby Settings	<p>Microphone Selecting On enables the function, and the microphone can be used even in standby mode.</p> <p>Monitor Out Selecting On enables the function. The projector can output a VGA signal when it is in standby mode and the PC jack is correctly connected to devices. See "Connection" on page 23 for how to make the connection.</p> <p>Audio Pass Through Press ◀/▶ to choose the source that you wish to use in operation mode. See "Connection" on page 23 for how to make the connection.</p> <p>When the corresponding jacks are correctly connected to the device, the projector can output an audio signal to the external speaker when it is in standby mode. The built-in speaker(s) will be muted in standby mode.</p> <p> Enabling this function slightly increases the standby power consumption.</p>
			<p>Reset All Settings</p> <p> The following settings will still remain: Position, Phase, H. Size, Projector Installation, Language, High Altitude Mode, Security Settings, Baud Rate.</p>

FUNCTION		DESCRIPTION
6. Information menu	Current System Status	Source Shows the current signal source.
		Picture Mode Shows the selected mode in the Picture menu.
		Lamp Mode Shows the current lamp mode.
		Resolution Shows the native resolution of the input signal.
		3D Format Shows the current 3D mode.
		Color System Shows input system format, NTSC, PAL, SECAM or RGB.
		Lamp Usage Time Displays the number of hours the lamp has been used.
		Firmware Version Displays the firmware version of the projector.

 The Information menu shows you the current operating status of the projector.

Maintenance

Care of the projector

Your projector needs little maintenance. The only thing you need to do on a regular basis is to keep the lens clean.

Never remove any parts of the projector except the lamp. Contact your dealer if other parts need replacing.

Cleaning the lens

Clean the lens whenever you notice dirt or dust on the surface.

- Use a canister of compressed air to remove dust.
- If there is dirt or smears, use lens-cleaning paper or moisten a soft cloth with lens cleaner and gently wipe the lens surface.



Never use any type of abrasive pad, alkaline/acid cleaner, scouring powder, or volatile solvent, such as alcohol, benzene, thinner or insecticide. Using such materials or maintaining prolonged contact with rubber or vinyl materials may result in damage to the projector surface and cabinet material.

Cleaning the projector case

Before you clean the case, turn the projector off using the proper shutdown procedure as described in "[Shutting down the projector](#)" on [page 46](#) and unplug the power cord.

- To remove dirt or dust, wipe the case with a soft, lint-free cloth.
- To remove stubborn dirt or stains, moisten a soft cloth with water and a neutral pH detergent. Then wipe the case.



Never use wax, alcohol, benzene, thinner or other chemical detergents. These can damage the case.

Storing the projector

If you need to store the projector for an extended time, please follow the instructions below:

- Make sure the temperature and humidity of the storage area are within the recommended range for the projector. Please refer to "[Specifications](#)" on [page 67](#) or consult your dealer about the range.
- Retract the adjuster feet.
- Remove the battery from the remote control.
- Pack the projector in its original packing or equivalent.

Transporting the projector

It is recommended that you ship the projector with its original packing or equivalent. When you carry the projector yourself, please use the original box or a suitable soft carry case.

Lamp information

Getting to know the lamp hour

When the projector is in operation, the duration (in hours) of lamp usage is automatically calculated by the built-in timer. The method of calculating the equivalent lamp hour is as follows:

Lamp Usage Time = (hours used in Normal mode) + (hours used in Economic mode) + (hours used in SmartEco mode)

Equivalent lamp hour = 2.2*(hours used in Normal mode) + 1.4*(hours used in Economic mode) + 1.00*(hours used in SmartEco mode)

 See "[Setting Lamp mode as Economic or SmartEco](#)" below for more information on Economic mode.

To obtain the lamp hour information:

1. Press **MENU/EXIT** and then press **◀/▶** until the **SYSTEM SETUP: Advanced** menu is highlighted.
2. Press **▼** to highlight **Lamp Settings** and press **MODE/ENTER**. The **Lamp Settings** page displays.
3. You will see the **Lamp Timer** information displaying on the menu.
4. To leave the menu, press **MENU/EXIT**.

You can also get the lamp hour information on the **INFORMATION** menu.

Extending lamp life

The projection lamp is a consumable item. To keep the lamp life as long as possible, you can do the following settings via the OSD menu.

Setting Lamp mode as Economic or SmartEco

Using **Economic** mode reduces system noise and power consumption by 20%. Using **SmartEco** mode reduces system noise and lamp power consumption by up to 70%. If the **Economic** or **SmartEco** mode is selected, the light output will be reduced and result in darker projected pictures.

Setting the projector in **Economic** or **SmartEco** mode also extends the lamp operation life. To set **Economic** or **SmartEco** mode, go into the **SYSTEM SETUP: Advanced > Lamp Settings > Lamp mode** menu and press **◀/▶** until your desired mode is selected.

Lamp mode	Description
Normal	100% lamp brightness
Economic	Saves 20% lamp power consumption.
SmartEco	Save up to 30% lamp power consumption depending on the content brightness level.

Setting Auto Power Off

This function allows the projector to turn off automatically if no input source is detected after a set period of time to prevent unnecessary waste of lamp life.

To set **Auto Power Off**, go into the **SYSTEM SETUP: Basic > Auto Power Off** menu and press ◀/▶. The time period can be set from 5 to 30 minutes in 5-minute increments. If the preset time lengths are not suitable for your presentation, select **Disable**. The projector will not automatically shut down in a certain time period.

Timing of replacing the lamp



When the **Lamp indicator** lights up red or a message appears suggesting it is time to replace the lamp, please install a new lamp or consult your dealer. An old lamp may cause a malfunction in the projector and in some instances the lamp may explode.

Go to <http://www.benq.com> for a replacement lamp.

 **The Lamp indicator light and Temperature warning light will light up if the lamp becomes too hot. Turn the projector off and let the projector cool for 45 minutes. If the lamp or Temp indicator still lights up after turning the power back on, please contact your dealer. See "Indicators" on page 65 for details.**

The following lamp warning displays will remind you to change the lamp.

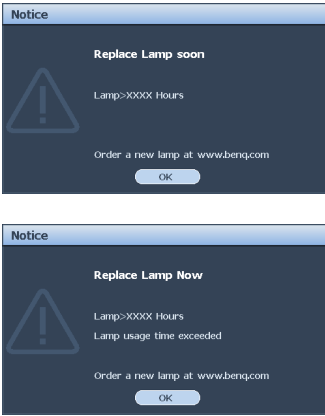
 **The warning messages below are for reference only. Please follow the actual on-screen instructions to prepare and replace the lamp.**

Status	Message
<p>Install a new lamp for optimal performance. If the projector is normally run with Economic selected (See "Setting Lamp mode as Economic or SmartEco" on page 59), you may continue to operate the projector until the next lamp warning appears.</p> <p>Press MODE/ENTER to dismiss the message.</p>	 <p>The screenshot shows a dark blue background with a white 'Notice' header. A warning triangle icon is on the left. The text reads: 'Order Replacement Lamp', 'Lamp>XXXX Hours', 'Order a new lamp at www.benq.com', and an 'OK' button at the bottom.</p>
<p>It is strongly recommended that you replace the lamp at this age. The lamp is a consumable item. The lamp brightness diminishes with use. This is normal lamp behavior. You can replace the lamp whenever you notice that the brightness level has significantly diminished.</p> <p>Press MODE/ENTER to dismiss the message.</p>	 <p>Two screenshots are shown. The first is titled 'Replace Lamp soon' and the second is titled 'Replace Lamp Now'. Both have a dark blue background, a white 'Notice' header, a warning triangle icon, and text: 'Lamp>XXXX Hours', 'Order a new lamp at www.benq.com', and an 'OK' button. The 'Replace Lamp Now' message also includes 'Lamp usage time exceeded'.</p>
<p>The lamp MUST be replaced before the projector will operate normally.</p> <p>Press MODE/ENTER to dismiss the message.</p>	 <p>The screenshot shows a dark blue background with a white 'Notice' header. A warning triangle icon is on the left. The text reads: 'Out of Lamp Usage Time', 'Replace lamp (Refer to user manual). Then reset lamp timer.', 'Order a new lamp at www.benq.com', and an 'OK' button at the bottom.</p>

Replacing the lamp



- If lamp replacement is performed while the projector is suspended upside-down from the ceiling, make sure that no one is underneath the lamp socket to avoid any possible injury or damage to the human eyes caused by fractured lamp.
- To reduce the risk of electrical shock, always turn the projector off and disconnect the power cord before changing the lamp.
- To reduce the risk of severe burns, allow the projector to cool for at least 45 minutes before replacing the lamp.
- To reduce the risk of injuries to fingers and damage to internal components, use caution when removing lamp glass that has shattered into sharp pieces.
- To reduce the risk of injuries to fingers and/or compromising image quality by touching the lens, do not touch the empty lamp compartment when the lamp is removed.
- This lamp contains mercury. Consult your local hazardous waste regulations to dispose of this lamp in a proper manner.
- To assure optimal performance from the projector, it is recommended that you purchase a BenQ projector lamp for lamp replacement.
- Ensure good ventilation when handling broken lamps. We recommend that you use respirators, safety glasses, goggles or face shield and wear protective clothing such as gloves.

1. Turn the power off and disconnect the projector from the wall socket. If the lamp is hot, avoid burns by waiting for approximately 45 minutes until the lamp has cooled.
2. Loosen the captive screws from the left and rear side.
3. Remove the lamp compartment cover as shown.

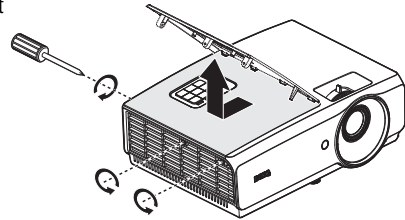

4. Disconnect the lamp connector from the projector as illustrated.

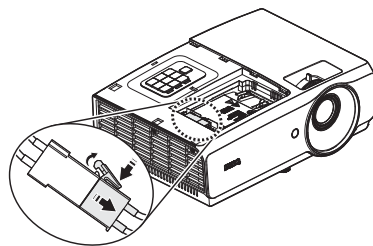

- Loosen the two captive screws that secure the lamp.



- Do not turn the power on with the lamp cover removed.
- Do not insert your fingers between the lamp and the projector. The sharp edges inside the projector may cause injuries.

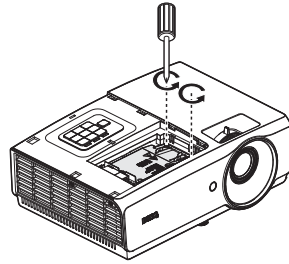

- Lift the handle so that it stands up. Use the handle to slowly pull the lamp out of the projector.



- Pulling it too quickly may cause the lamp to break and scatter broken glass in the projector.
- Do not place the lamp in locations where water might splash on it, children can reach it, or near flammable materials.
- Do not insert your hands into the projector after the lamp is removed. If you touch the optical components inside, it could cause color unevenness and distortion of the projected images.

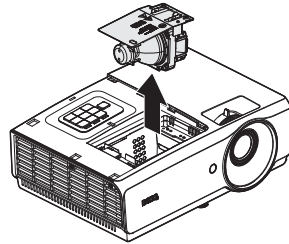

- Insert the new lamp into the lamp compartment and make sure it fits in the projector.



- Ensure the connectors are aligned.
- If you experience resistance, lift the lamp and start again.

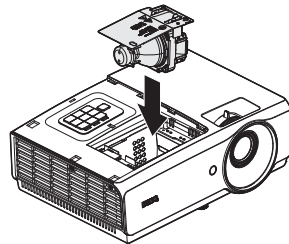

- Tighten the screws that secure the lamp.
- Ensure the handle is fully laid flat and locked in place.



- Loose screw may cause a bad connection, which could result in malfunction.
- Do not over tighten the screw.

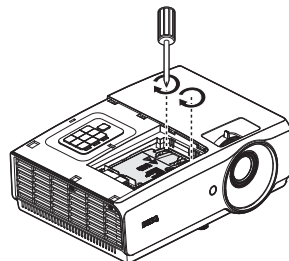

10. Connect the lamp connector properly and place as drawing before lamp compartment cover installation back.



- Lamp connector must be installed flush with the connector base as shown in the image below. A gap between the lamp connector and the connector base will cause damage to the projector. The following images illustrate correct and incorrect lamp connector installations.

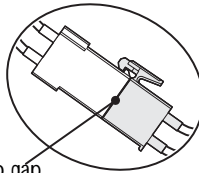
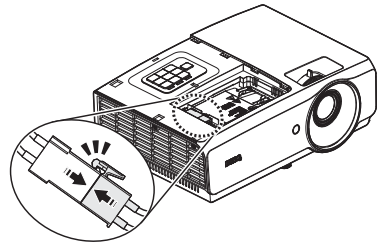

No gap

Correct

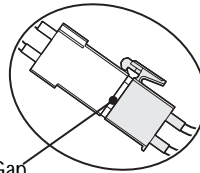

Gap

Incorrect

11. Replace the lamp compartment cover on the projector and tighten the captive screw.

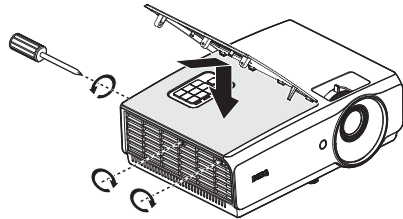

12. Restart the projector.



- Do not turn the power on with the lamp cover removed.

Resetting the lamp timer

13. After the startup logo, open the On-Screen Display (OSD) menu. Go to the **SYSTEM SETUP: Advanced > Lamp Settings** menu. Press **MODE/ENTER**. The **Lamp Settings** page displays. Highlight **Reset lamp timer**. A warning message displays asking if you want to reset the lamp timer. Highlight **Reset** and press **MODE/ENTER**. The lamp time will be reset to '0'.



- Do not reset if the lamp is not new or replaced as this could cause damage.

Indicators

Light			Status & Description
Power	Temp	Lamp	
Power events			
Orange	Off	Off	Stand-by mode
Green Flashing	Off	Off	Powering up
Green	Off	Off	Normal operation
Orange Flashing	Off	Off	Projector is cooling.
Lamp events			
Off	Off	Orange Flashing	The lamp ignition is not lit up.
Off	Off	Red	1. The projector needs 90 seconds to cool down. Or 2. Please contact your dealer for assistance.
Thermal events			
Red	Red	Off	The fans are not working.
Red	Green	Off	
Red	Green Flashing	Off	
Green	Red	Off	Temperature 1 error (over limited temperature).
Green	Red Flashing	Off	Thermal sensor 1 open error.
Green	Green	Off	Thermal sensor 1 short error.
Green	Green Flashing	Off	Thermal IC #1 I2C connection error.
Green	Red	Red	Thermal break error.
System events			
Green	Off	Red	The projector has shutdown automatically. If you try to re-start the projector, it will shutdown again. Please contact your dealer for assistance.
Red Flashing	Off	Off	
Red	Off	Red	
Off	Green	Red	Lamp door is open. Please check if the lamp door is open or not closed properly.
Green	Off	Orange	Lamp life exhausted.
Red	Off	Off	Download.

Troubleshooting

⑦ The projector does not turn on.

Cause	Remedy
There is no power from the power cable.	Plug the power cord into the AC inlet on the projector, and plug the power cord into the power outlet. If the power outlet has a switch, make sure that it is switched on.
Attempting to turn the projector on again during the cooling process.	Wait until the cooling down process has completed.

⑦ No picture.

Cause	Remedy
The video source is not turned on or connected correctly.	Turn the video source on and check that the signal cable is connected correctly.
The projector is not correctly connected to the input signal device.	Check the connection.
The input signal has not been correctly selected.	Select the correct input signal with the SOURCE key on the projector or remote control.

⑦ Blurred image.

Cause	Remedy
The projection lens is not correctly focused.	Adjust the focus of the lens using the focus ring.
The projector and the screen are not aligned properly.	Adjust the projection angle and direction as well as the height of the unit if necessary.
The lens cover is still closed.	Open the lens cover.

⑦ Remote control does not work.

Cause	Remedy
The battery is out of power.	Replace the battery with new one.
There is an obstacle between the remote control and the projector.	Remove the obstacle.
You are too far away from the projector.	Stand within 7 meters (23 feet) of the projector.

⑦ The password is incorrect.

Cause	Remedy
You do not remember the password.	Please see "Entering the password recall procedure" on page 32 for details.

Specifications

Projector specifications

 All specifications are subject to change without notice.

Optical

Resolution
MH684
1920 x 1080
Display system
Single-chip DLP™ system
Lens F/Number
F=2.59 to 2.91, f=16.87 to 21.87mm
Lamp
240W lamp

Electrical

Power supply
AC100-240V
50-60 Hz (Automatic)
3.5A
Power consumption
350W (Max); < 0.5W (Standby)

Mechanical

Weight
7.28 lbs (3.3 Kg)

Output terminals

Speaker
(Mono) 10 watt x 1
Audio signal output
PC audio jack x 1
Monitor Out
D-Sub 15-pin (female) x1
USB
TYPE-A (5V/1.5A)

Control

USB
MINI-B
RS-232 serial control
9 pin x 1
IR receiver x 2

Input terminals

PC input
RGB input
D-Sub 15-pin (female) x 1
Video signal input
S-VIDEO
Mini DIN 4-pin port x 1
VIDEO
RCA jack x 1
SD/HDTV signal input
Digital - HDMI-1 x 1
Digital - HDMI-2/MHL x 1
Audio signal input
Audio in
PC audio jack x 1
RCA audio jack (L/R) x 1
MIC
PC audio jack x 1

Environmental Requirements

Operating temperature
0°C–40°C at sea level
Operating relative humidity
10%–90% (without condensation)
Operating altitude
0–1499 m at 0°C–35°C
1500–3000 m at 0°C–30°C (with
High Altitude Mode on)

Dimensions

314.2 mm (W) x 116 mm (H) x 216.3 mm (D)

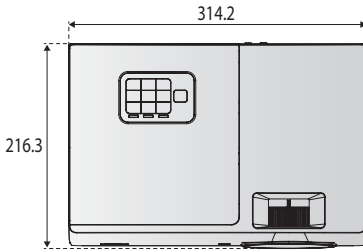

Unit: mm

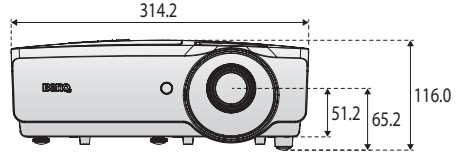

Ceiling Mount Installation

*Ceiling Mount Screws:
M4 (Max. L=25, Min. L=20)

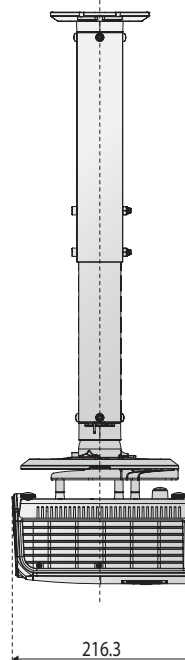
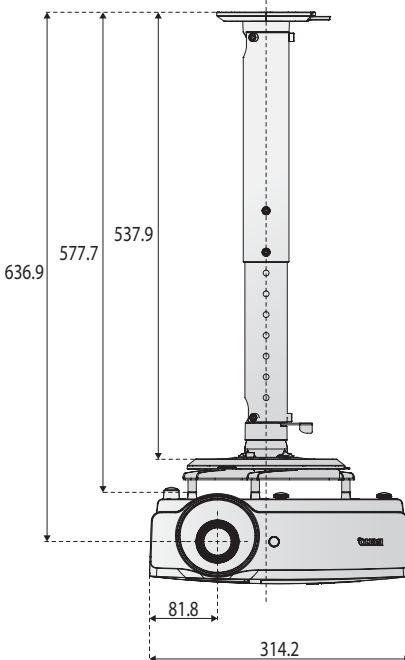
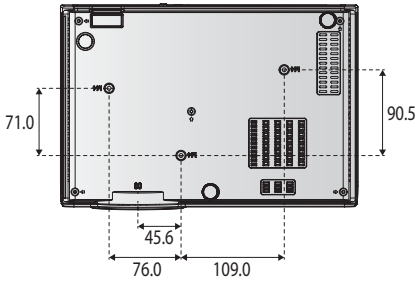

Timing chart

Supported timing for PC input

Resolution	Mode	Refresh rate (Hz)	H-frequency (kHz)	Clock (MHz)	3D Field Sequential	3D over-under	3D side-by-side
720 x 400	720 x 400_70	70.087	31.469	28.3221			
640 x 480	VGA_60	59.940	31.469	25.175	⊙	⊙	⊙
	VGA_72	72.809	37.861	31.500			
	VGA_75	75.000	37.500	31.500			
	VGA_85	85.008	43.269	36.000			
800 x 600	SVGA_60	60.317	37.879	40.000	⊙	⊙	⊙
	SVGA_72	72.188	48.077	50.000			
	SVGA_75	75.000	46.875	49.500			
	SVGA_85	85.061	53.674	56.250			
	SVGA_120 (Reduce Blanking)	119.854	77.425	83.000	⊙		
1024 x 768	XGA_60	60.004	48.363	65.000	⊙	⊙	⊙
	XGA_70	70.069	56.476	75.000			
	XGA_75	75.029	60.023	78.750			
	XGA_85	84.997	68.667	94.500			
	XGA_120 (Reduce Blanking)	119.989	97.551	115.500	⊙		
1152 x 864	1152 x 864_75	75.00	67.500	108.000			
1024 x 576	BenQ NB Timing	60.00	35.820	46.996			
1024 x 600	BenQ NB Timing	64.995	41.467	51.419			
1280 x 720	1280 x 720_60	60	45.000	74.250	⊙	⊙	⊙
1280 x 768	1280 x 768_60	59.870	47.776	79.5	⊙	⊙	⊙
1280 x 800	WXGA_60	59.810	49.702	83.500	⊙	⊙	⊙
	WXGA_75	74.934	62.795	106.500			
	WXGA_85	84.880	71.554	122.500			
	WXGA_120 (Reduce Blanking)	119.909	101.563	146.25	⊙		
1280 x 1024	SXGA_60	60.020	63.981	108.000		⊙	⊙
	SXGA_75	75.025	79.976	135.000			
	SXGA_85	85.024	91.146	157.500			

Resolution	Mode	Refresh rate (Hz)	H-frequency (kHz)	Clock (MHz)	3D Field Sequential	3D over-under	3D side-by-side
1280 x 960	1280 x 960_60	60.000	60.000	108		⊙	⊙
	1280 x 960_85	85.002	85.938	148.500			
1360 x 768	1360 x 768_60	60.015	47.712	85.500		⊙	⊙
1440 x 900	WXGA+_60	59.887	55.935	106.500		⊙	⊙
1400 x 1050	SXGA+_60	59.978	65.317	121.750		⊙	⊙
1600 x 1200	UXGA	60.000	75.000	162.000		⊙	⊙
1680 x 1050	1680 x 1050_60	59.954	65.290	146.250		⊙	⊙
640 x 480 @67Hz	MAC13	66.667	35.000	30.240			
832 x 624 @75Hz	MAC16	74.546	49.722	57.280			
1024 x 768 @75Hz	MAC19	74.93	60.241	80.000			
1152 x 870 @75Hz	MAC21	75.06	68.68	100.00			
1920x1080 @60Hz	1920 x 1080_60 (Reduce Blanking)	60	67.5	148.5			
1920x1200 @60Hz	1920 x 1200_60 (Reduce Blanking)	59.95	74.038	154			

☞ There 3D timing showing depend the EDID file and VGA display card. It is possible that user cannot choose the above 3D timings on VGA display card.

Support timing for Component - YPbPr input

Timing	Resolution	Horizontal frequency (KHz)	Vertical Frequency (Hz)	Dot Clock Frequency (MHz)	3D Field Sequential
480i	720 x 480	15.73	59.94	13.5	⊙
480p	720 x 480	31.47	59.94	27	⊙
576i	720 x 576	15.63	50	13.5	
576p	720 x 576	31.25	50	27	
720/50p	1280 x 720	37.5	50	74.25	
720/60p	1280 x 720	45.00	60	74.25	⊙
1080/50i	1920 x 1080	28.13	50	74.25	
1080/60i	1920 x 1080	33.75	60	74.25	
1080/24p	1920 x 1080	27	24	74.25	
1080/25p	1920 x 1080	28.13	25	74.25	
1080/30p	1920 x 1080	33.75	30	74.25	
1080/50p	1920 x 1080	56.25	50	148.5	
1080/60p	1920 x 1080	67.5	60	148.5	

Support timing for Video and S-Video input

Video mode	Horizontal frequency (KHz)	Vertical Frequency (Hz)	Sub-carrier Frequency (MHz)	3D Field Sequential
NTSC	15.73	60	3.58	◎
PAL	15.63	50	4.43	
SECAM	15.63	50	4.25 or 4.41	
PAL-M	15.73	60	3.58	
PAL-N	15.63	50	3.58	
PAL-60	15.73	60	4.43	
NTSC4.43	15.73	60	4.43	

Support timing for HDMI (HDCP) input

Resolution	Mode	Refresh rate (Hz)	H-frequency (kHz)	Clock (MHz)	3D Field Sequential	3D over-under	3D side-by-side
640 x 480	VGA_60	59.940	31.469	25.175	◎	◎	◎
	VGA_72	72.809	37.861	31.500			
	VGA_75	75.000	37.500	31.500			
	VGA_85	85.008	43.269	36.000			
720 x 400	720 x 400_70	70.087	31.469	28.3221			
800 x 600	SVGA_60	60.317	37.879	40.000	◎	◎	◎
	SVGA_72	72.188	48.077	50.000			
	SVGA_75	75.000	46.875	49.500			
	SVGA_85	85.061	53.674	56.250			
	SVGA_120 (Reduce Blanking)	119.854	77.425	83.000	◎		
1024 x 768	XGA_60	60.004	48.363	65.000	◎	◎	◎
	XGA_70	70.069	56.476	75.000			
	XGA_75	75.029	60.023	78.750			
	XGA_85	84.997	68.667	94.500			
	XGA_120 (Reduce Blanking)	119.989	97.551	115.500	◎		
1152 x 864	1152 x 864_75	75.00	67.500	108.000			
1024 x 576	BenQ Notebook Timing	60.00	35.820	46.996			
1024 x 600	BenQ Notebook Timing	64.995	41.467	51.419			
1280 x 720	1280 x 720_60	60	45.000	74.250	◎	◎	◎

Resolution	Mode	Refresh rate (Hz)	H-frequency (kHz)	Clock (MHz)	3D Field Sequential	3D over-under	3D side-by-side
1280 x 768	1280 x 768_60	59.870	47.776	79.5	⊙	⊙	⊙
1280 x 800	WXGA_60	59.810	49.702	83.500	⊙	⊙	⊙
	WXGA_75	74.934	62.795	106.500			
	WXGA_85	84.880	71.554	122.500			
	WXGA_120 (Reduce Blanking)	119.909	101.563	146.25	⊙		
1280 x 1024	SXGA_60	60.020	63.981	108.000		⊙	⊙
	SXGA_75	75.025	79.976	135.000			
	SXGA_85	85.024	91.146	157.500			
1280 x 960	1280 x 960_60	60.000	60.000	108		⊙	⊙
	1280 x 960_85	85.002	85.938	148.500			
1360 x 768	1360 x 768_60	60.015	47.712	85.500		⊙	⊙
1440 x 900	WXGA+_60	59.887	55.935	106.500		⊙	⊙
1400 x 1050	SXGA+_60	59.978	65.317	121.750		⊙	⊙
1600 x 1200	UXGA	60.000	75.000	162.000		⊙	
1680 x 1050	1680 x 1050_60	59.954	65.290	146.250		⊙	⊙
640 x 480 @67Hz	MAC13	66.667	35.000	30.240			
832 x 624 @75Hz	MAC16	74.546	49.722	57.280			
1024 x 768 @75Hz	MAC19	75.020	60.241	80.000			
1152 x 870 @75Hz	MAC21	75.06	68.68	100.00			
1920x1080 @60Hz	1920 x 1080_60 (Reduce Blanking)	60	67.5	148.5			
1920x1200 @60Hz	1920 x 1200_60 (Reduce Blanking)	59.95	74.038	154			

ⓘ These timing showing depend the EDID file and VGA graphic card limitation. It is possible that user cannot choose the above timings on VGA display card.

Supporting timing for HDMI Video input

Timing	Resolution	Horizontal frequency (KHz)	Vertical frequency (Hz)	Dot Clock Frequency (MHz)	3D Field Sequential	3D frame packing	3D over-under	3D side-by-side
480i	720 (1440) x 480	15.73	59.94	27	⊙			
480p	720 x 480	31.47	59.94	27	⊙			
576i	720 (1440) x 576	15.63	50	27				
576p	720 x 576	31.25	50	27				
720/50p	1280 x 720	37.5	50	74.25		⊙	⊙	⊙
720/60p	1280 x 720	45.00	60	74.25	⊙	⊙	⊙	⊙
1080/24p	1920 x 1080	27	24	74.25		⊙	⊙	⊙
1080/25p	1920 x 1080	28.13	25	74.25				
1080/30p	1920 x 1080	33.75	30	74.25				
1080/50i	1920 x 1080	28.13	50	74.25				⊙
1080/60i	1920 x 1080	33.75	60	74.25				⊙
1080/50p	1920 x 1080	56.25	50	148.5			⊙	⊙
1080/60p	1920 x 1080	67.5	60	148.5			⊙	⊙

Supporting timing for MHL input

Timing	Resolution	Horizontal frequency (KHz)	Vertical frequency (Hz)	Dot Clock Frequency (MHz)
480i*	720 (1440) x 480	15.73	59.94	27
480p	720 x 480	31.47	59.94	27
576i*	720 (1440) x 576	15.63	50	27
576p	720 x 576	31.25	50	27
720/50p	1280 x 720	37.5	50	74.25
720/60p	1280 x 720	45.00	60	74.25
1080/24p	1920 x 1080	27	24	74.25
1080/25p	1920 x 1080	28.13	25	74.25
1080/30p	1920 x 1080	33.75	30	74.25
1080/50i	1920 x 1080	28.13	50	74.25
1080/60i	1920 x 1080	33.75	60	74.25

Warranty and Copyright information

Limited warranty

BenQ warrants this product against any defects in material and workmanship, under normal usage and storage.

Proof of purchase date will be required with any warranty claim. In the event this product is found to be defective within the warranty period, BenQ's only obligation and your exclusive remedy shall be replacement of any defective parts (labor included). To obtain warranty service, immediately notify the dealer from which you purchased the product of any defects.

Important: The above warranty shall be void if the customer fails to operate the product in accordance with BenQ's written instructions, especially the ambient humidity must be in-between 10% and 90%, temperature in-between 0°C and 35°C, altitude lower than 4920 feet, and avoiding to operate the projector in a dusty environment. This warranty gives you specific legal rights, and you may have other rights which vary from country to country.

For other information, please visit www.BenQ.com.

Copyright

Copyright 2011 by BenQ Corporation. All rights reserved. No part of this publication may be reproduced, transmitted, transcribed, stored in a retrieval system or translated into any language or computer language, in any form or by any means, electronic, mechanical, magnetic, optical, chemical, manual or otherwise, without the prior written permission of BenQ Corporation.

Disclaimer

BenQ Corporation makes no representations or warranties, either expressed or implied, with respect to the contents hereof and specifically disclaims any warranties, merchantability or fitness for any particular purpose. Further, BenQ Corporation reserves the right to revise this publication and to make changes from time to time in the contents hereof without obligation to notify any person of such revision or changes.

*DLP, Digital Micromirror Device and DMD are trademarks of Texas Instruments. Others are copyrights of their respective companies or organizations.

Patents

Please go to <http://patmarking.benq.com/> for the details of the BenQ projector patent.