



TH670
Digital Projector
User Manual



Table of contents

Important safety

instructions 3

Introduction..... 7

Projector features.....7

Shipping contents8

Projector exterior view..... 10

Controls and functions 11

Positioning your

projector 16

Choosing a location..... 16

Obtaining a preferred projected image
size..... 17

Connection 19

Connecting a computer20

Connecting Video source devices.....21

Operation 24

Starting up the projector24

Adjusting the projected image25

Using the menus.....28

Securing the projector31

Switching input signal33

Selecting the aspect ratio34

Optimizing the image36

Advanced picture quality controls39

Hiding the image.....42

Operating in a high altitude
environment.....42

Adjusting the sound.....43

Locking control keys43

Personalizing the projector menu
display44

Select the lamp saver mode.....44

Shutting down the projector.....45

Menu operation 46

Maintenance 60

Care of the projector 60

Lamp information 61

Troubleshooting..... 69

Specifications..... 70

Dimensions 71

Ceiling mount installation..... 71

Timing chart..... 72

**Warranty and Copyright
information..... 76**

Important safety instructions

Your projector is designed and tested to meet the latest standards for safety of information technology equipment. However, to ensure safe use of this product, it is important that you follow the instructions mentioned in this manual and marked on the product.

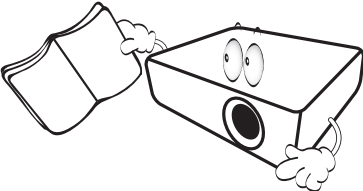
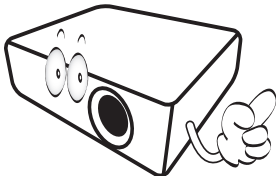
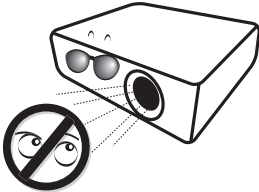
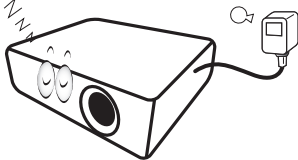
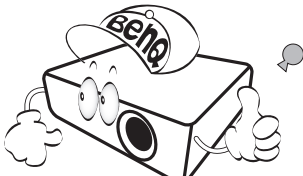
Safety Instructions	
<p>1. Please read this manual before you operate your projector. Save it for future reference.</p> 	<p>4. Always open the lens shutter or remove the lens cap when the projector lamp is on.</p> 
<p>2. Do not look straight at the projector lens during operation. The intense light beam may damage your eyes.</p> 	<p>5. In some countries, the line voltage is NOT stable. This projector is designed to operate safely within a mains voltage between 100 to 240 volts AC, but could fail if power cuts or surges of ± 10 volts occur. In areas where the mains voltage may fluctuate or cut out, it is recommended that you connect your projector through a power stabilizer, surge protector or uninterruptible power supply (UPS).</p> 
<p>3. Refer servicing to qualified service personnel.</p> 	<p>6. Do not block the projection lens with any objects when the projector is under operation as this could cause the objects to become heated and deformed or even cause a fire.</p>

Safety Instructions (Continued)

7. The lamp becomes extremely hot during operation. Allow the projector to cool for approximately 45 minutes prior to removing the lamp assembly for replacement.

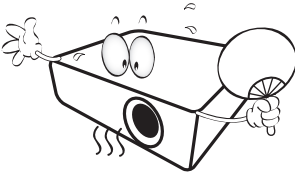

8. Do not operate lamps beyond the rated lamp life. Excessive operation of lamps beyond the rated life could cause them to break on rare occasions.

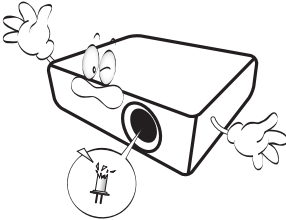

9. Never replace the lamp assembly or any electronic components unless the projector is unplugged.

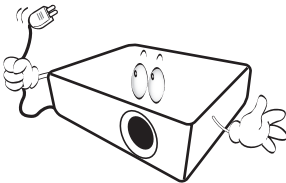

10. Do not place this product on an unstable cart, stand, or table. The product may fall, sustaining serious damage.

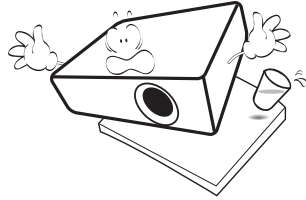

11. Do not attempt to disassemble this projector. There are dangerous high voltages inside which may cause death if you should come into contact with live parts. Under no circumstances should you ever undo or remove any other covers. Refer servicing only to suitably qualified professional service personnel.

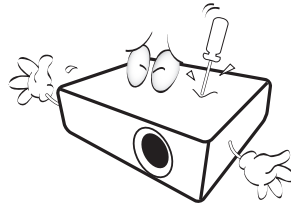

12. When the projector is under operation, you may sense some heated air and odor from its ventilation grill. It is a normal phenomenon and not a product defect.

Safety Instructions (Continued)

13. Do not place this projector in any of the following environments.
- Space that is poorly ventilated or confined. Allow at least 50 cm clearance from walls and free flow of air around the projector.
 - Locations where temperatures may become excessively high, such as the inside of a car with all windows rolled up.
 - Locations where excessive humidity, dust, or cigarette smoke may contaminate optical components, shortening the projector's life span and darkening the image.

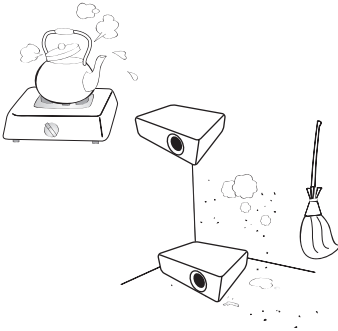

- Locations near fire alarms
- Locations with an ambient temperature above 40°C / 104°F
- Locations where the altitudes are higher than 3000 m (10000 feet).

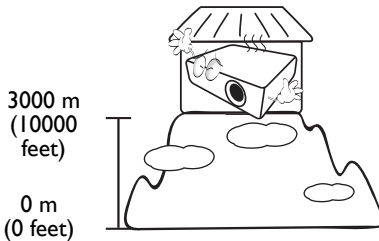

14. Do not block the ventilation holes.
- Do not place this projector on a blanket, bedding or any other soft surface.
 - Do not cover this projector with a cloth or any other item.
 - Do not place inflammables near the projector.

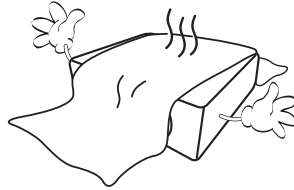

If the ventilation holes are seriously obstructed, overheating inside the projector may result in a fire.

15. Always place the projector on a level, horizontal surface during operation.
- Do not use if tilted at an angle of more than 10 degrees left to right, nor at angle of more than 15 degrees front to back. Using the projector when it is not fully horizontal may cause a malfunction of, or damage to, the lamp.



Safety Instructions (Continued)

16. Do not stand the projector on end vertically. Doing so may cause the projector to fall over, causing injury or resulting in damage to the projector.

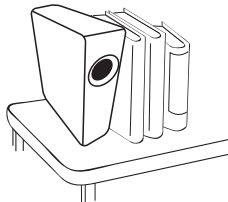

17. Do not step on the projector or place any objects upon it. Besides probable physical damage to the projector, doing so may result in accidents and possible injury.

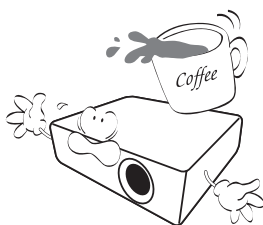

18. Do not place liquids near or on the projector. Liquids spilled into the projector may cause it to fail. If the projector does become wet, disconnect it from the power supply's wall socket and call BenQ to have the projector serviced.

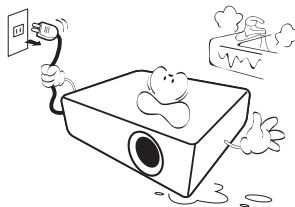

19. This product is capable of displaying inverted images for ceiling mount installation.



Use only BenQ's Ceiling Mount Kit for mounting the projector and ensure it is securely installed.

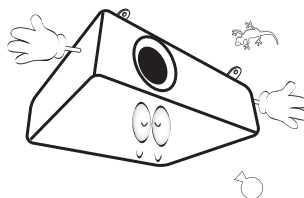

Introduction

Projector features

This model is one of the best projectors available in the world. You can enjoy the best video quality across various devices such as PC, laptop, DVD and VCR even document camera to bring all possibility to life.

The projector offers the following features.

- **Basic and Advanced menu types for your selection.**
 - **USB A supports USB charging (can't support USB reader)**
 - **Wall color correction allowing projection on surfaces of several predefined colors**
 - **Auto source speeding up the signal detecting process**
 - **Color management allowing color adjustments to your liking**
 - **Selectable quick cooling function makes the projector cool in a shorter time**
 - **One-key auto-adjustment to display the best picture quality**
 - **Component HDTV compatibility (YPbPr)**
 - **Less than 0.5 W power consumption in standby mode**
-  • **The apparent brightness of the projected image will vary depending on the ambient lighting conditions, selected input signal contrast/brightness settings, and is proportional to projection distance.**
- **The lamp brightness will decline over time and may vary within the lamp manufacturers specifications. This is normal and expected behavior.**

Shipping contents

Carefully unpack and verify that you have all of the items shown below. If any of these items are missing, please contact your place of purchase.

Standard accessories

 The supplied accessories will be suitable for your region, and may differ from those illustrated.

***The warranty card is only supplied in some specific regions. Please consult your dealer for detailed information.**

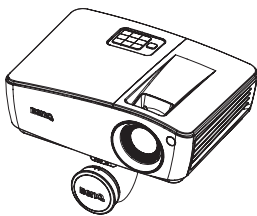

Projector

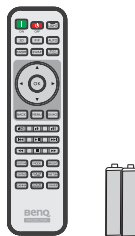

Remote control & batteries

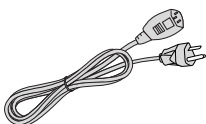

Power cord



Warranty card*



Quick start guide



User manual CD

Optional accessories

1. Spare lamp kit
2. Ceiling mount kit
3. carry bag
4. 3D glasses

Projector exterior view

Front/upper side

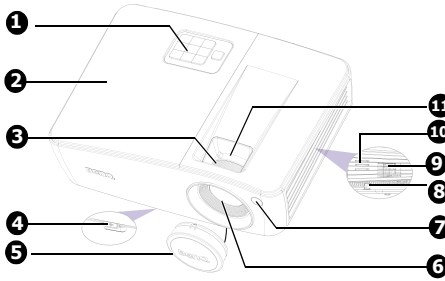

Rear/lower side

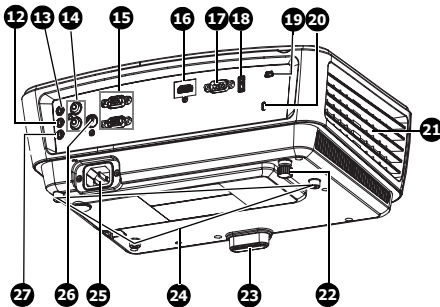







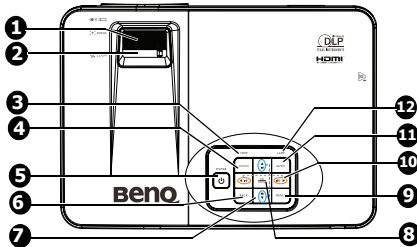

1. External control panel
(See "Projector" on page 11 for details.)
2. Lamp cover
3. Focus ring
4. Quick-release button
5. Lens cover
6. Projection lens
7. Front IR remote sensor
8. Security bar
9. Ventilation holes (intake)
10. Speaker
11. Zoom ring
12. Audio output jack
13. Audio input jack
14. Audio (L/R) input jack
15. RGB (PC)/Component video (YPbPr/ YCbCr) signal input jack
16. HDMI input jack
17. RS-232 control port
18. USB type A/1.5A jack
19. USB mini-B jack
20. Kensington anti-theft lock slot
21. Ventilation holes (exhaust)
22. Rear adjuster foot
23. Quick-release adjuster foot
24. Ceiling mount holes
25. AC power cord inlet
26. Video input jack
27. Microphone input jack

Controls and functions

Projector



- 1. Focus ring**
Adjusts the focus of the projected image.
- 2. Zoom ring**
Adjusts the size of the image.
- 3. TEMPERATURE indicator light**
Lights up red if the projector's temperature becomes too high. See ["Indicators" on page 67](#) for details.
- 4. SOURCE**
Displays the source selection bar. See ["Switching input signal" on page 33](#) for details.
- 5.  POWER/POWER indicator light**
Toggles the projector between standby mode and on. See ["Starting up the projector" on page 24](#) for details.
Lights up or flashes when the projector is under operation. See ["Indicators" on page 67](#) for detail.
- 6. BACK**
Goes back to previous OSD menu, and closes projector OSD menu when it's on the top level.
- 7. Keystone/Arrow keys ( /  Up,  /  Down)**
Displays Keystone page and adjusts the vertical keystone values. See ["Correcting keystone" on page 26](#) for details.
- 8. OK/MODE**
Activates the selected On-Screen Display (OSD) menu item. See ["Using the menus" on page 28](#) for details.
Selects an available picture setup mode. See ["Selecting a picture mode" on page 36](#) for details.
- 9. MENU**
Turns on or off the On-Screen Display (OSD) menu.
- 10. Volume/Arrow keys ( /  Left,  Right)**
Adjusts the sound level.
When the On-Screen Display (OSD) menu is activated, the #7, and #10 keys are used as directional arrows to select the desired menu items and to make adjustments. See ["Using the menus" on page 28](#) for details.
- 11. AUTO**
Automatically determines the best picture timings for the displayed image. See ["Auto-adjusting the image" on page 26](#) for details.
- 12. LAMP indicator light**
Indicates the status of the lamp. Lights up or flashes when the lamp has developed a problem. See ["Indicators" on page 67](#) for details.



Mounting the projector

We want you to have a pleasant experience using your BenQ projector, so we need to bring this safety matter to your attention to prevent possible damage to person and property.

If you intend to mount your projector on the ceiling or wall, we strongly recommend that you use a proper fitting BenQ projector ceiling mount kit or wall mount kit and that you ensure it is securely and safely installed.

If you use a non-BenQ brand projector mounting kit, there is a safety risk that the projector may fall from the ceiling or wall due to an improper attachment through the use of the wrong gauge or length screws.

You can purchase a BenQ projector ceiling mount or wall mount kit from the place you purchased your BenQ projector. BenQ recommends that you also purchase a separate Kensington lock compatible security cable and attach it securely to both the Kensington lock slot on the projector and the base of the mounting bracket. This will perform the secondary role of restraining the projector should its attachment to the mounting bracket become loose.

Remote control

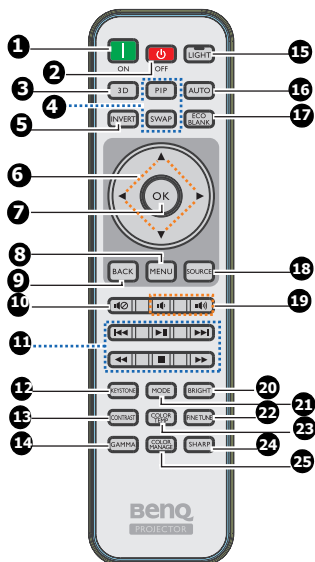

1. **ON**
Turns on the projector.
2. **OFF**
Turns off the projector.
3. **3D**
Activates the 3D On-Screen Display (OSD) menu item.
4. **PIP/SWAP**
Not operational on this projector.
5. **INVERT**
Inverts right/left eye picture when 3D mode is activated.
6. **Arrow keys (▲ Up, ▼ Down, ◀ Left, ▶ Right)**
When the On-Screen Display (OSD) menu is activated, the keys are used as directional arrows to select the desired menu items and to make adjustments.
7. **OK**
Activates the selected On-Screen Display (OSD) menu item.
8. **MENU**
Turns on or off the On-Screen Display (OSD) menu.
9. **BACK**
Goes back to previous OSD menu, and closes projector OSD menu when it's on the top level.
10. **Mute (🔇)**
Toggles projector audio between on and off.
11. **Play buttons (◀◀ Previous, ◀◀ Rewind, ▶▶ Play/Pause, ■ Stop, ▶▶ Next, ▶▶ Fast forward)**
Not operational on this projector.
12. **KEYSTONE**
Displays Keystone page.
13. **CONTRAST**
Displays the contrast setting bar.
14. **GAMMA**
Selects a gamma value.
15. **LIGHT**
Enables backlight functions of the remote control's buttons.
16. **AUTO**
Automatically determines the best picture timings for the displayed image.
17. **ECO BLANK**
Press the **ECO BLANK** button to turn off the image for a period of time with 70% lamp power saving. Press again to restore the image.

18. SOURCE

Displays the source selection bar.

19. Volume (▶||/▶||)

Adjusts the sound level.

20. BRIGHT

Displays the brightness setting bar.

21. MODE

Selects an available picture setup mode.

22. FINE TUNE

Displays Color Temperature Fine Tuning setting bar.

23. COLOR TEMP

Displays the color temperature setting bar.

24. SHARP

Displays the sharpness setting bar.

25. COLOR MANAGE

Displays the color management setting bar.

Infra-Red (IR) remote control sensor is located on the front of the projector. The remote control must be held at an angle within 30 degrees perpendicular to the projector's IR remote control sensor to function correctly. The distance straight line between the remote control and the sensor should not exceed 8 meters (~ 26 feet).

Make sure that there are no obstacles between the remote control and the IR sensor on the projector that might obstruct the infra-red beam.

- **Operating the projector from the front**

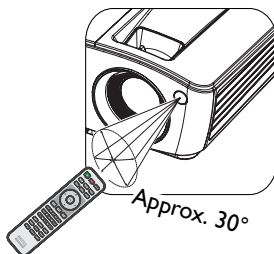

Replacing the remote control battery

1. To open the battery cover, turn the remote control over to view its back, push on the finger grip on the cover and slide it up in the direction of the arrow as illustrated. The cover will slide off.
2. Remove any existing batteries (if necessary) and install two AAA batteries observing the battery polarities as indicated in the base of the battery compartment. Positive (+) goes to positive and negative (-) goes to negative.
3. Refit the cover by aligning it with the base and sliding it back down into position. Stop when it clicks into place.

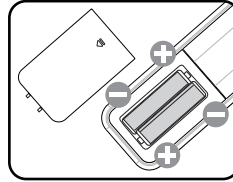
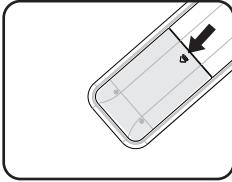

- **Avoid excessive heat and humidity.**
- **There may be battery damage if the battery is incorrectly replaced.**
- **Replace only with the same or equivalent type recommended by the battery manufacturer.**
- **Dispose of the used battery according to the battery manufacturer's instructions.**
- **Never throw a battery into a fire. There may be danger of an explosion.**
- **If the battery is dead or if you will not be using the remote control for a long time, remove the battery to prevent damage to the remote control from possible battery leakage.**

Positioning your projector

Choosing a location

Your room layout or personal preference will dictate which installation location you select. Take into consideration the size and position of your screen, the location of a suitable power outlet, as well as the location and distance between the projector and the rest of your equipment.

Your projector is designed to be installed in one of four possible installation locations:

1. Front Table

Select this location with the projector placed near the floor in front of the screen. This is the most common way to position the projector for quick setup and portability.

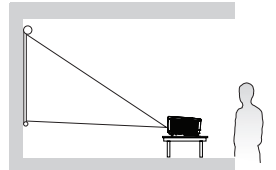

2. Front Ceiling

Select this location with the projector suspended upside-down from the ceiling in front of the screen.

Purchase the BenQ Projector Ceiling Mounting Kit from your dealer to mount your projector on the ceiling.

Set **Front Ceiling** in the **Projector Position*** menu after you turn the projector on.

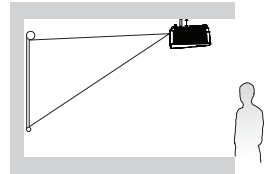

3. Rear Table

Select this location with the projector placed near the floor behind the screen.

Note that a special rear projection screen is required.

Set **Rear Table** in the **Projector Position*** menu after you turn the projector on.

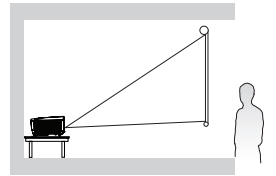



4. Rear Ceiling

Select this location with the projector suspended upside-down from the ceiling behind the screen.

Note that a special rear projection screen and the BenQ Projector Ceiling Mounting Kit are required for this installation location.

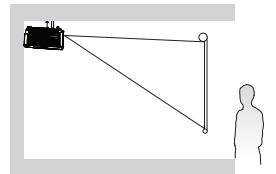
Set **Rear Ceiling** in the **Projector Position*** menu after you turn the projector on.



 *There are two menu types for your selection. One is **Basic**, and the other is **Advanced**. From the **Basic** menu, you can select **Projector Position** when the projector is without input signal. From the **Advanced** menu, you can select **Projector Position** in the **System Setup: Basic** menu. See "[Using the menus](#)" on page [28](#) for details.

Obtaining a preferred projected image size

The distance from the projector lens to the screen, the zoom setting (if available), and the video format each factors in the projected image size.

The projector should always be placed horizontally level (like flat on a table), and positioned directly perpendicular (90° right-angle square) to the horizontal center of the screen. This prevents image distortion caused by angled projections (or projecting onto angled surfaces).

If the projector is mounted on a ceiling, it must be mounted upside-down so that it projects at a slightly downward angle.

You can see from the diagram on page 18, that this type of projection causes the bottom edge of the projected image to be vertically offset from the horizontal plane of the projector. When ceiling mounted, this refers to the top edge of the projected image.

If the projector is positioned further away from the screen, the projected image size increases, and the vertical offset also increases proportionately.

When determining the position of the screen and projector, you will need to account for both the projected image size and the vertical offset dimension, which are proportional to the projection distance.

BenQ has provided a table of screen sizes to assist you in determining the ideal location for your projector. There are two dimensions to consider, the perpendicular horizontal distance from the center of the screen (projection distance), and the vertical offset height of the projector from the horizontal edge of the screen (offset).

Projection dimensions

Refer to "Dimensions" on page 71 for the center of lens dimensions of this projector before calculating the appropriate position.

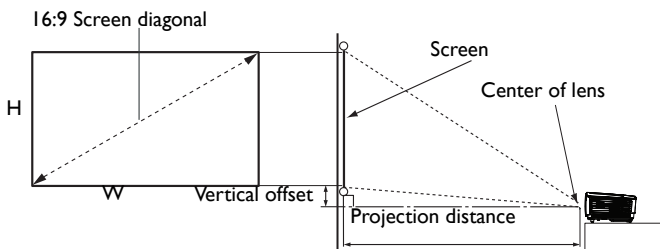

Screen size				Distance from screen (mm)			Vertical offset (mm)
Diagonal		W	H	Min length	Average	Max length	
Inch	mm	(mm)	(mm)	(max. zoom)		(min. zoom)	
30	762	664	374	994	1097	1200	60
40	1016	886	498	1325	1463	1600	80
60	1524	1328	747	1988	2194	2400	120
80	2032	1771	996	2651	2926	3200	159
100	2540	2214	1245	3313	3657	4000	199
120	3048	2657	1494	3976	4388	4800	239
150	3810	3321	1868	4970	5485	6000	299
200	5080	4428	2491	6627	7314	8000	399
250	6350	5535	3113	8283	9142	10000	498
300	7620	6642	3736	9940	10970	12000	598

For example, If you are using a 60-inch screen, the projection distance is 2194 mm and with a vertical offset of 120 mm.

If your measured projection distance is 5.5 m (5500 mm), the closest match in the "Distance from screen (mm)" column is 5485 mm. Looking across this row shows that a 150" (about 3810 mm) screen is required.

 **All measurements are approximate and may vary from the actual sizes. BenQ recommends that if you intend to permanently install the projector, you should physically test the projection size and distance using the actual projector in situ before you permanently install it, so as to make allowance for this projector's optical characteristics. This will help you determine the exact mounting position so that it best suits your installation location.**

Connection

When connecting a signal source to the projector, be sure to:

1. Turn all equipment off before making any connections.
2. Use the correct signal cables for each source.
3. Ensure the cables are firmly inserted.



• In the connections shown below, some cables may not be included with the projector (see **"Shipping contents" on page 8**). They are commercially available from electronics stores.

• For detailed connection methods, see pages **20-23**.

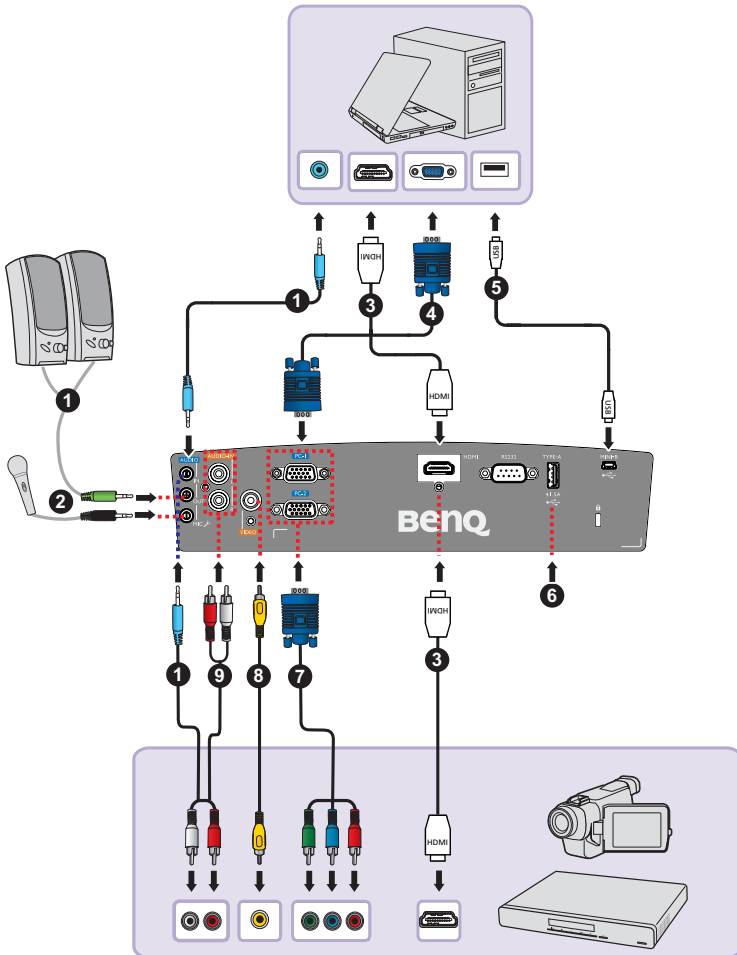

1. Audio cable	6. USB port for power charging
2. Microphone 3.5 mini jack cable	7. Component Video to VGA (DSub) adapter cable
3. HDMI cable	8. Video cable
4. VGA cable	9. Audio L/R cable
5. USB cable (mini-B to type A)	

Connecting a computer

The projector can connect to both IBM® compatibles and Macintosh® computers. A Mac adapter is needed if you are connecting legacy version Macintosh computers.

To connect the projector to a notebook or desktop computer (using VGA):

1. Take the supplied VGA cable and connect one end to the D-Sub output socket of the computer.
2. Connect the other end of the VGA cable to the **PC-1** or **PC-2** signal input jack on the projector.
3. If you wish to make use of the projector speaker(s) in your presentations, take a suitable audio cable and connect one end of the cable to the audio output jack of the computer, and the other end to the **AUDIO IN** jack of the projector. When you connect audio output signal from a computer, please balance out the volume control bar to obtain an optimal sound effects.
4. If you wish, you can use another suitable audio cable and connect one end of the cable to the **AUDIO OUT** jack of the projector, and the other end to your external speakers (not supplied).

Once connected, the audio can be controlled by the projector On-Screen Display (OSD) menus. See "[Audio Setup](#)" on page 48 for details.

The built-in speaker will be muted when the **AUDIO OUT** jack is connected.



To connect the projector to a notebook or desktop computer (using HDMI):

1. Take a HDMI cable and connect one end to the HDMI jack of the computer.
2. Connect the other end of the cable to the **HDMI** jack on the projector.

 **Many notebooks do not turn on their external video ports when connected to a projector. Usually a key combo like FN + F3 or CRT/LCD key turns the external display on/off. Locate a function key labeled CRT/LCD or a function key with a monitor symbol on the notebook. Press FN and the labeled function key simultaneously. Refer to your notebook's documentation to find your notebook's key combination.**

Connecting Video source devices

You need only connect the projector to a Video source device using just one of the above connecting methods, however each provides a different level of video quality. The method you choose will most likely depend upon the availability of matching terminals on both the projector and the Video source device as described below:

Terminal name	Terminal appearance	Reference	Picture quality
HDMI	HDMI 	"Connecting an HDMI source device" on page 21	Best
Component Video	PC-1/PC-2 	"Connecting a Component Video source device" on page 22	Better
Video	VIDEO 	"Connecting a composite source device" on page 23	Good

Connecting an HDMI source device

The projector provides an HDMI input jack that allows you to connect it to an HDMI source device like a DVD player, a DTV tuner, a display or a notebook computer.

HDMI (High-Definition Multimedia Interface) supports uncompressed video data transmission between compatible devices like DTV tuners, DVD players and displays over a single cable. It provides pure digital viewing and listening experience.

Examine your Video source device to determine if it has a set of unused HDMI output jacks available:

- **If so, you can continue with this procedure.**
- **If not, you will need to reassess which method you can use to connect to the device.**

To connect the projector to an HDMI source device:

1. Take an HDMI cable and connect one end to the HDMI output jack of the HDMI source device.
2. Connect the other end of the cable to the **HDMI** signal input jack on the projector. Once connected, the audio can be controlled by the projector On-Screen Display (OSD) menus. See "[Audio Setup](#)" on page 48 for details.

-  • **If the selected video image is not displayed after the projector is turned on and the correct video source has been selected, check that the Video source device is turned on and operating correctly. Also check that the signal cables have been connected correctly.**

- In the unlikely event that you connect the projector to a DVD player via the projector's HDMI input and the projected picture displays wrong colors, please change the color space to YUV.

Connecting a Component Video source device

Examine your Video source device to determine if it has a set of unused Component Video output jacks available:

- **If so, you can continue with this procedure.**
- **If not, you will need to reassess which method you can use to connect to the device.**

To connect the projector to a Component Video source device:

1. Take a Component Video to VGA (D-Sub) adaptor cable and connect the end with 3 RCA type connectors to the Component Video output jacks of the Video source device. Match the color of the plugs to the color of the jacks; green to green, blue to blue, and red to red.
2. Connect the other end of the Component Video to VGA (D-Sub) adaptor cable (with a D-Sub type connector) to the **PC-1** or **PC-2** jack on the projector.
3. If you wish to make use of the projector speaker(s) in your presentations, take a suitable audio cable and connect one end of the cable to the audio output jack of the device, and the other end to the **AUDIO (L/R)** jack of the projector.
4. If you wish, you can use another suitable audio cable and connect one end of the cable to the **AUDIO OUT** jack of the projector, and the other end to your external speakers (not supplied).

Once connected, the audio can be controlled by the projector On-Screen Display (OSD) menus. See "[Audio Setup](#)" on page 48 for details.

The built-in speaker will be muted when the **AUDIO OUT** jack is connected.

 **If the selected video image is not displayed after the projector is turned on and the correct video source has been selected, check that the Video source device is turned on and operating correctly. Also check that the signal cables have been connected correctly.**

Connecting a composite source device

Examine your Video source device to determine if it has an unused composite output jack available:

- **If so, you can continue with this procedure.**
- **If not, you will need to reassess which method you can use to connect to the device.**

To connect the projector to a Video source device:

1. Take a Video cable and connect one end to the Video output jack of the Video source device.
2. Connect the other end of the Video cable to the **VIDEO** jack on the projector.
3. If you wish to make use of the projector speaker(s) in your presentations, take a suitable audio cable and connect one end of the cable to the audio output jack of the device, and the other end to the **AUDIO (L/R)** jack of the projector.
4. If you wish, you can use another suitable audio cable and connect one end of the cable to the **AUDIO OUT** jack of the projector, and the other end to your external speakers (not supplied).

Once connected, the audio can be controlled by the projector On-Screen Display (OSD) menus. See "[Audio Setup](#)" on page 48 for details.

The built-in speaker will be muted when the **AUDIO OUT** jack is connected.

 **If the selected video image is not displayed after the projector is turned on and the correct video source has been selected, check that the Video source device is turned on and operating correctly. Also check that the signal cables have been connected correctly.**

Operation

Starting up the projector

1. Plug the power cord into the projector and into a power outlet. Check that the **POWER indicator light** on the projector lights orange after power has been applied.



- Please use the original accessories (e.g. power cable) only with the device to avoid possible dangers such as electric shock and fire.
- If **Direct Power On** function (in the **Advanced menu > System Setup: Basic**)* is activated, the projector will turn on automatically after the power cord has been connected and power has been applied. See "**Direct Power On**" on page 56 for details.
- *There are two menu types for your selection. One is **Basic**, and the other is **Advanced**. From the **Basic** menu, you can select **Menu Type** when the projector is without input signal. From the **Advanced** menu, you can select **Menu Type** in the **System Setup: Basic > Menu Settings** menu. See "**Using the menus**" on page 28 for details.

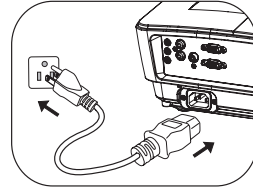

2. Make sure the lens cover is open. If it is closed, it could become deformed due to the heat produced by the projection lamp.

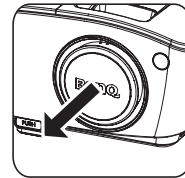

3. Press **POWER** on the projector or **ON** on the remote control to start the projector. The **POWER indicator light** flashes and stays green when the projector is on.

The start up procedure takes about 10-20 seconds. In the later stage of start up, a startup logo is projected.

(If necessary) Use the focus ring to adjust the image clearness.

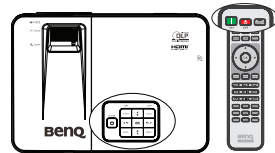

If the projector is still hot from previous activity, it will run the cooling fan for approximately 90 seconds before energizing the lamp.

4. If the projector is activated for the first time, follow the on-screen instructions to complete the setup.
5. If you are prompted for a password, press the arrow keys to enter a six digit password. See "**Utilizing the password function**" on page 31 for details.
6. Switch all of the connected equipment on.

7. The projector will start to search for input signals. The current input signal being scanned displays in the screen. If the projector doesn't detect a valid signal, the message '**No Signal**' will continue displaying until an input signal is found. You can also press **SOURCE** on the projector or remote control to select your desired input signal. See "[Switching input signal](#)" on page 33 for details.

 • If no signal is detected for 3 minutes, the projector automatically enters **ECO BLANK** mode.

Adjusting the projected image

Adjusting the projection angle

The projector is equipped with 1 quick-release adjuster foot and 1 rear adjuster foot. These adjusters change the image height and projection angle. To adjust the projector:

1. Press the quick-release button and lift the front of the projector. Once the image is positioned where you want it, release the quick-release button to lock the foot in position.
2. Screw the rear adjuster foot to fine tune the horizontal angle.

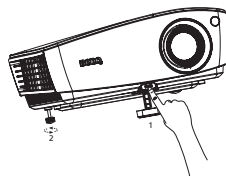

To retract the foot, hold up the projector while pressing the quick-release button, then slowly lower the projector. Screw the rear adjuster foot in a reverse direction.

If the projector is not placed on a flat surface or the screen and the projector are not perpendicular to each other, the projected image becomes trapezoidal. To correct this situation, see "[Correcting keystone](#)" on page 26 for details.

-  • **Do not look into the lens while the lamp is on. The strong light from the lamp may cause damage to your eyes.**
- **Be careful when you press the adjuster button as it is close to the exhaust vent where hot air comes from.**

Auto-adjusting the image

In some cases, you may need to optimize the picture quality. To do this, press **AUTO** on the projector or remote control. Within 5 seconds, the built-in Intelligent Auto Adjustent function will re-adjust the values of Frequency and Clock to provide the best picture quality.

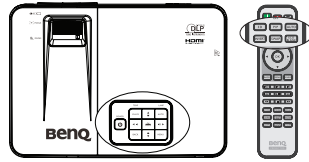

- The screen will display "Auto adjusting" while **AUTO** is functioning.
- This function is only available when PC signal (analog RGB) is selected.

Correcting keystone

Keystoning refers to the situation where the projected image is noticeably wider at either the top or bottom. It occurs when the projector is not perpendicular to the screen.

To correct this, you can follow one of these steps.

- Auto V-Keystone adjustment
1. Press **▲/▼** or **KEYSTONE** on the remote control to display the **Keystone** page.

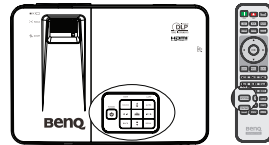

2. Press **OK** for 2 seconds to enable Auto V-Keystone.
- Manual V-Keystone adjustment
1. Press **▲/▼** or **KEYSTONE** on the remote control to display the **Keystone** page.

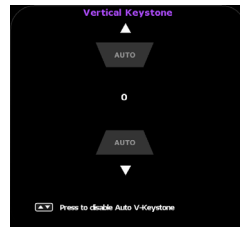

2. Press **▲/▼** to adjust the V-Keystone manually.

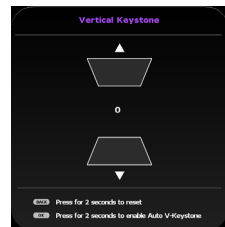

Fine-tuning the image size and clarity

1. Adjust the projected image to the size that you need using the zoom slide lever.

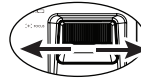

2. Then sharpen the image by using the focus ring.

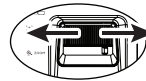
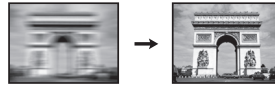

Using the menus

The projector is equipped with On-Screen Display (OSD) menus for making various adjustments and settings. There are two menu types for your selection. One is **Basic**, and the other is **Advanced**.

Below is the overview of the **Basic menu** -- without input signal.

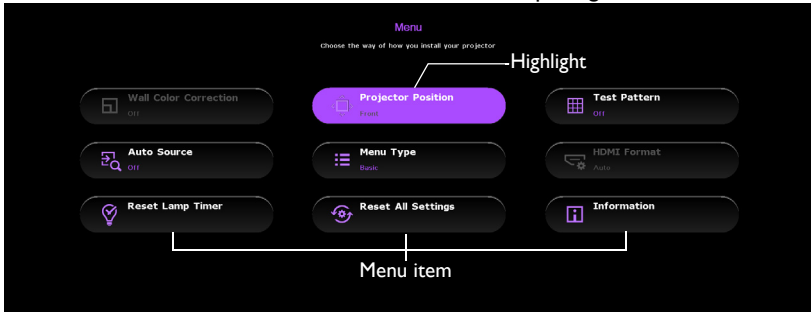

The following example describes how to set the OSD menu in the **Basic menu**.

1. Press **MENU** to turn the OSD menu on.

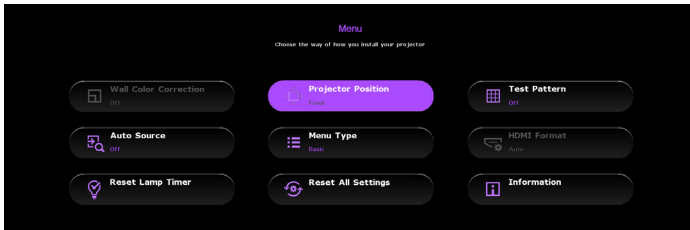

2. Use **▲/▼/◀/▶** to select the desired item and press **OK** to confirm the selection.

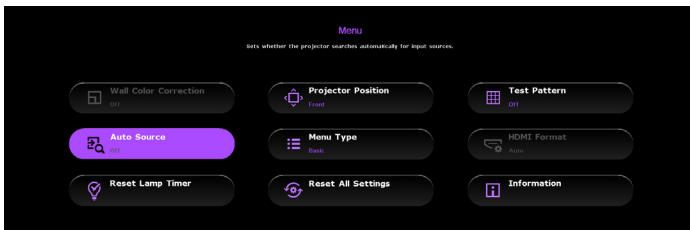

3. Follow the on-screen instructions to select your settings.

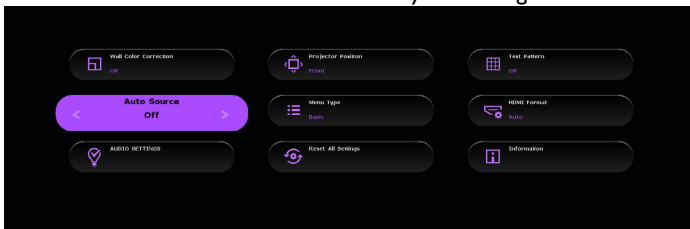

4. Press **MENU** to leave and save the settings.

Below is the overview of the **Basic menu** -- with input signal.

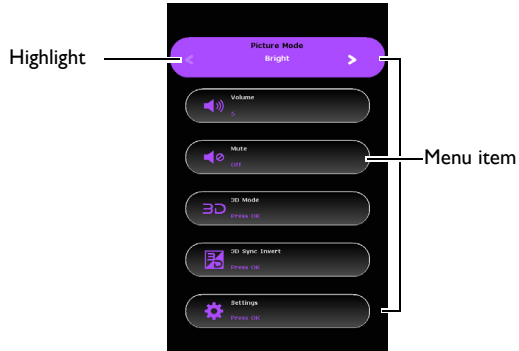

The following example describes how to set the OSD menu in the **Basic menu**.

1. Press **MENU** to turn the OSD menu on.
2. Use ▲/▼ to select the desired item and follow the on-screen instructions to select your settings.
3. Press **MENU** to leave and save the settings.

Below is the overview of the **Advanced** menu.

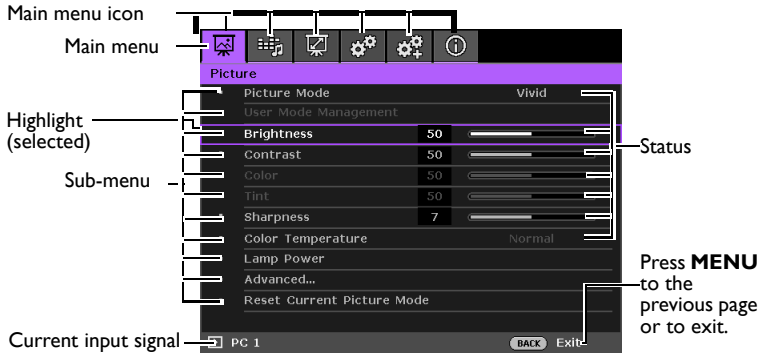

The following example describes how to set the OSD menu.

1. Press **MENU** to turn the OSD menu on.

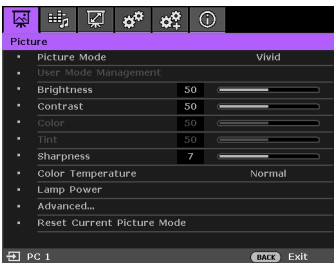

3. Press **▼** to select **Background Color** and press **◀/▶** to select a background color.

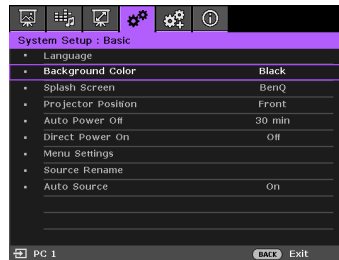

2. Use **◀/▶** to select the **System Setup: Basic** menu.

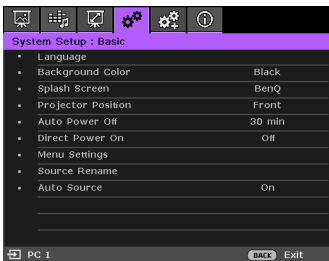

4. Press **MENU** to leave and save the settings.

Securing the projector

Using a security cable lock

The projector has to be installed in a safe place to prevent theft. Otherwise, purchase a lock, such as the Kensington lock, to secure the projector. You can locate a Kensington lock slot on the rear side of the projector. See item 20 on page 10 for details.

A Kensington security cable lock is usually a combination of key(s) and the lock. Refer to the lock's documentation for finding out how to use it.

Utilizing the password function

For security purposes and to help prevent unauthorized use, the projector includes an option for setting up password security. The password can be set through the On-Screen Display (OSD) menu.

WARNING: You will be inconvenienced if you activate the power-on lock functionality and subsequently forget the password. Print out this manual (if necessary) and write the password you used in this manual, and keep the manual in a safe place for later recall.

Setting a password

Once a password has been set, the projector cannot be used unless the correct password is entered every time the projector is started.

1. Open the OSD menu and make sure the **Menu Type** is **Advanced**. See "Using the menus" on page 28 for details.
2. Go to the **System Setup: Advanced > Password > Change Password** menu, and press **OK** on the projector or remote control.
3. Enter the new or current password. As pictured to the right, the four arrow keys (▲, ▶, ▼, ◀) respectively represent 4 digits (1, 2, 3, 4). According to the password you desire to set, press the arrow keys to enter six digits for the password.
4. Confirm the new password by re-entering the new password. Once the password is set, the OSD menu returns to the **Password** page.

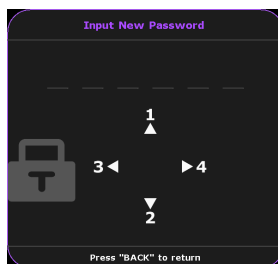

IMPORTANT: The digits being input will display as asterisks on-screen. Write your selected password down here in this manual in advance or right after the password is entered so that it is available to you should you ever forget it.

Password: _____

Keep this manual in a safe place.

5. Press ▼ to select **Power On Lock** and select **On** by pressing ◀/▶.
6. To leave the OSD menu, press **MENU** on the projector or remote control.

If you forget the password

If the password function is activated, you will be asked to enter the six-digit password every time you turn on the projector. If you enter the wrong password, the password error message as pictured to the right displays lasting for three seconds, and the message **'Input Current Password'** follows. You can retry by entering another six-digit password, or if you did not record the password in this manual, and you absolutely do not remember it, you can use the password recall procedure. See ["Entering the password recall procedure"](#) on page 32 for details.

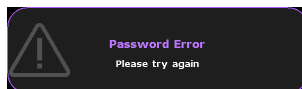

If you enter an incorrect password 5 times in succession, the projector will automatically shut down in a short time.

Entering the password recall procedure

1. Press and hold **AUTO** on the projector or remote control for 3 seconds. The projector will display a coded number on the screen.
2. Write down the number and turn off your projector.
3. Seek help from the local BenQ service center to decode the number. You may be required to provide proof of purchase documentation to verify that you are an authorized user of the projector.

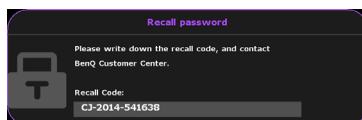

Changing the password

1. Open the OSD menu and make sure the **Menu Type** is **Advanced**. See ["Using the menus"](#) on page 28 for details.
2. Go to the **System Setup: Advanced > Password > Change Password** menu, and press **OK** on the projector or remote control.
3. The message **'Input Current Password'** displays.
4. Enter the old password.
 - If the password is correct, another message **'Input New Password'** displays.
 - If the password is incorrect, the password error message displays lasting for three seconds, and the message **'Input Current Password'** displays for your retry. You can press **BACK** on the projector or the remote control to cancel the change or try another password.
5. Enter a new password.

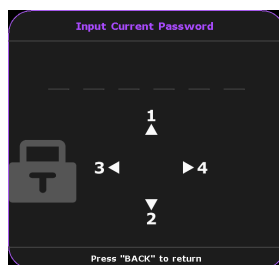

IMPORTANT: The digits being input will display as asterisks on-screen. Write your selected password down here in this manual in advance or right after the password is entered so that it is available to you should you ever forget it.

Password: _____

Keep this manual in a safe place.

6. Confirm the new password by re-entering the new password.
7. You have successfully assigned a new password to the projector. Remember to enter the new password next time the projector is started.
8. To leave the OSD menu, press **MENU** on the projector or remote control.

Disabling the password function

To disable password protection, go back to the **System Setup: Advanced > Password > Power On Lock** menu and press **OK** on the projector or the remote control. The message 'Input Password' displays. Enter the current password.

- If the password is correct, the OSD menu returns to the **Power On Lock** with the highlight of **Off**.
- If the password is incorrect, the password error message displays lasting for three seconds, and the message 'Input Password' displays for your retry. You can press **BACK** on the projector or remote control to cancel the change or try another password.

☞ Though the password function is disabled, you need to keep the old password in hand should you ever need to re-activate the password function by entering the old password.

Switching input signal

The projector can be connected to multiple devices at the same time. However, it can only display one full screen at a time. When starting up, the projector automatically searches for the available signals.

Be sure the **Auto Source*** function is **On** (which is the default of this projector) if you want the projector to automatically search for the signals.

☞ *You can set **Auto Source** function in the **Basic** menu when the projector is without input signal or in the **Advanced** menu > **System Setup: Basic** menu.

You can also manually cycle through the available input signals.

1. Press **SOURCE** on the projector or remote control. A source selection bar displays.

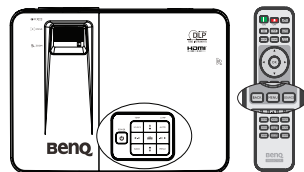

2. Press ▲/▼ until your desired signal is selected and press **OK** on the projector or remote control.

Once detected, the selected source information will display on the screen for seconds. If there is multiple equipment connected to the projector, repeat steps 1-2 to search for another signal.



- **The brightness level of the projected image will change accordingly when you switch between different input signals. Data (graphic) "PC" presentations using mostly static images are generally brighter than "Video" using mostly moving images (movies).**
- **The input signal type effects the options available for the Picture Mode. See "[Selecting a picture mode](#)" on page 36 for details.**
- **The native display resolution is in a 16:9 aspect ratio. For best display picture results, you should select and use an input signal which outputs at this resolution. Any other resolutions will be scaled by the projector depending upon the 'aspect ratio' setting, which may cause some image distortion or loss of picture clarity. See "[Selecting the aspect ratio](#)" on page 34 for details.**

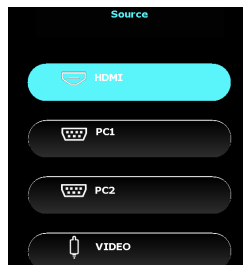

Selecting the aspect ratio

The 'aspect ratio' is the ratio of the image width to the image height.

With the advent of digital signal processing, digital display devices like this projector can dynamically stretch and scale the image output to a different aspect than that of the image input signal.

To change the projected image ratio (no matter what aspect the source is):

1. Open the OSD menu and make sure the **Menu Type** is **Advanced**. See "[Using the menus](#)" on page 28 for details.
2. Go to the **Display > Aspect Ratio** menu.
3. Press ◀/▶ to select an aspect ratio to suit the format of the video signal and your display requirements.

About the aspect ratio

 In the pictures below, the black portions are inactive areas and the white portions are active areas. OSD menus can be displayed on those unused black areas.

- Auto:** Scales an image proportionally to fit the projector's native resolution in its horizontal or vertical width. This is suitable for the incoming image which is neither in 4:3 nor 16:9 and you want to make most use of the screen without altering the image's aspect ratio.



4:3 picture
- 4:3:** Scales a picture so that it is displayed in the center of the screen with a 4:3 aspect ratio. This is most suitable for 4:3 pictures like computer monitors, standard definition TV and 4:3 aspect DVD movies, as it displays them without aspect alteration.

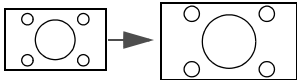

16:9 picture
- 16:9:** Scales an image so that it is displayed in the center of the screen with a 16:9 aspect ratio. This is most suitable for images which are already in a 16:9 aspect, like high definition TV, as it displays them without aspect alteration.



4:3 picture
- Wide:** Stretches the picture horizontally in a non-linear manner, that is, the edges of the picture are stretched more than the center of the picture to prevent distortion of the central part of the picture. This is suitable for occasions where you want to stretch the width of a 4:3 aspect picture to the width of a 16:9 aspect screen. It does not alter the height. Some widescreen movies have been produced with their width squashed down to the width of a 4:3 aspect, and are best viewed when restretched back to their original width using this setting.

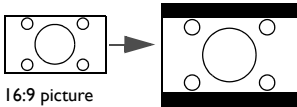

16:9 picture
- Letter Box (LB):** Scales a picture to fit the projector's native resolution in its horizontal width and resize the picture's height to the 3/4 of the projection width. This may produce a picture greater in height than can be displayed, so part of the picture is lost (not displayed) along the top and bottom edges of the projection. This is suitable for the display of movies which are presented in letter box format (with black bars on the top and bottom).

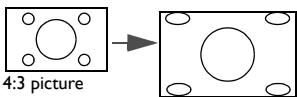

4:3 picture

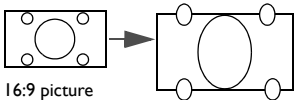

16:9 picture

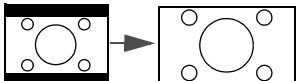

Letter Box format picture

Optimizing the image

Selecting a picture mode

The projector is preset with several predefined picture modes so that you can choose one to suit your operating environment and input signal picture type.

To select an operation mode that suits your need, you can follow one of the following steps.

- Press **MODE** on the projector or remote control repeatedly until your desired mode is selected.
- Go to the **Picture Mode** menu (which is in the **Basic menu** when the projector is with input signal or in the **Advanced menu > Picture** menu) and press ◀/▶ to select a desired mode.

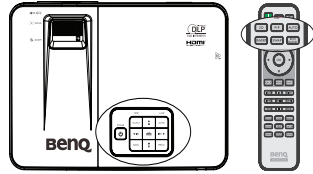

The picture modes are listed below.

1. **Bright** mode: Maximizes the brightness of the projected image. This mode is suitable for environments where extra-high brightness is required, such as using the projector in well lit rooms.
2. **Vivid** mode (Default): Is designed for presentations. The brightness is emphasized in this mode.
3. **Cinema** mode: Is appropriate for playing colorful movies, video clips from digital cameras or DVs through the PC input for best viewing in a blackened (little light) environment.
4. **Game** mode: Is appropriate for playing games.
5. **User 1/User 2** mode: Recalls the settings customized based on the current available picture modes. See "[Setting the User 1/User 2 mode](#)" on page 36 for details.

Setting the User 1/User 2 mode

There are two user-definable modes if the current available picture modes are not suitable for your need. You can use one of the picture modes (except the **User 1/User 2**) as a starting point and customize the settings.

1. Open the OSD menu and go to the **Picture Mode** function.
2. Press ◀/▶ to select **User 1** or **User 2**.
3. Press ▼ to select **User Mode Management**.

☞ This function is only available when **User 1** or **User 2** mode is selected up in the **Picture Mode** sub-menu item.

4. Press ◀/▶ to select a picture mode that is closest to your need.
5. Press ▼ to select a sub-menu item to be changed and adjust the value with ◀/▶. See "[Fine-tuning the image quality](#)" below for details.
6. The settings will be saved when selecting.

Renaming user modes

You can change User 1 and User 2 to the names easy to be identified or understood by the users of this projector. The new name can be up to 12 characters including English letters (A-Z, a-z), digits (0-9), and space (_).

To rename user modes:

1. Make sure the **Menu Type** is **Advanced**. See "Using the menus" on page 28 for details.
2. Go to the **Picture > Picture Mode > User 1** or **User 2** menu.
3. Go to the **User Mode Management > Rename User Mode** and press **OK** on the projector or remote control.
4. Press **▲/▼** to select the item you want to rename and press **OK** on the projector or remote control. The first letter will be highlighted by a white box.
5. Press **▲/▼** to select the first character.
6. Press **▶** to move along until the new name is set and press **OK** on the projector or remote control to confirm.
7. Repeat steps 4-6 if you want to change the other names.

Resetting current picture mode

All of the adjustments you've done in the **Advanced menu > Picture** menu (except for the **Picture Mode**) can be returned to the factory preset values with a key press on the selection of **Reset**.

To reset the picture mode to the preset factory values:

1. In the **Picture** menu, select **Picture Mode** and press **◀/▶** to select the picture mode (including **User 1** or **User 2**) you want to reset.
2. Press **▼** to select **Reset Current Picture Mode** and press **OK** on the projector or remote control. The confirmation message displays.
3. Press **◀/▶** to select **Reset** and press **OK** on the projector or remote control. The picture mode will return to the factory preset settings.
4. Repeat steps 1-3 if you want to reset other picture modes.



Do not to be confused with the Reset Current Picture Mode function here with the Reset All Settings (which is in the Basic menu when the projector is without input signal or in the Advanced menu > System Setup: Advanced menu). The Reset All Settings function returns most of the settings to the factory preset values system wide. See "Reset All Settings" on page 58 for details.

Using Wall Color Correction

In the situation where you are projecting onto a colored surface such as a painted wall which may not be white, the **Wall Color Correction** feature can help correct the projected picture's color to prevent possible color difference between the source and projected pictures.

To use this function, go to the **Advanced menu > Display > Wall Color Correction** menu and press **◀/▶** to select a color which is the closest to the color of the projection surface. There are several precalibrated colors to choose from: Light Yellow, Pink, Light Green and Blue.

Fine-tuning the image quality

According to the detected signal type, there are some user-definable functions available when **User 1** or **User 2** mode is selected. Based on your needs, you can make adjustments to these functions by selecting them and pressing ◀/ ▶ on the projector or remote control.

Adjusting Brightness

The higher the value, the brighter the image. And the lower the setting, the darker the image. Adjust this control so the black areas of the image appear just as black and that detail in the dark areas is visible.



Adjusting Contrast

The higher the value, the greater the contrast. Use this to set the peak white level after you have previously adjusted the **Brightness** setting to suit your selected input and viewing environment.



Adjusting Color

Lower setting produces less saturated colors. If the setting is too high, colors on the image will be overpowering, which makes the image unrealistic.

Adjusting Tint

The higher the value, the more reddish the picture becomes. The lower the value, the more greenish the picture becomes.

Adjusting Sharpness

The higher the value, the sharper the picture becomes. The lower the value, the softer the picture becomes.

You can also adjust **Brightness**, **Contrast** or **Sharpness** by using **BRIGHT**, **CONTRAST** or **SHARP** keys on the remote control.

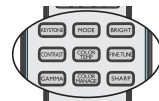

Advanced picture quality controls

There are more advanced functions in the **Advanced menu > Picture > Advanced...** menu to be adjusted to your preference. To save the settings, just press **MENU** to leave the OSD menu.

Setting Black Level

Select **Black Level** and press ◀/▶ on the projector or remote control to select 0 IRE or 7.5 IRE.

The grayscale video signal is measured in IRE units. In some areas which use NTSC TV standard, the grayscale is measured from 7.5 IRE (black) to 100 IRE (white); however, in other areas where PAL equipment or Japanese NTSC standards are used, the grayscale is measured from 0 IRE (black) to 100 IRE (white). We suggest that you check the input source to see if it is with 0 IRE or 7.5 IRE, then select accordingly.

Selecting a Gamma Selection

Select **Gamma Selection** in the **Advanced menu > Picture > Advanced...** menu and select the modes by pressing ◀/▶ on the projector or remote control.

Choose a preferred gamma mode from among 1.6/1.8/2.0/2.2/2.4/2.5/2.6/2.8/BenQ.

Gamma Correction enables adjustment to the light intensity (brightness) of an image in order to match the source more closely.

Adjusting Brilliant Color

Select **Brilliant Color** in the **Advanced menu > Picture > Advanced...** menu and select the modes by pressing ◀/▶ on the projector or remote control.

This feature utilizes a new color-processing algorithm and system level enhancements to enable higher brightness while providing truer, more vibrant colors in picture. It enables a greater than 50% brightness increase in mid-tone images, which are common in video and natural scenes, so the projector reproduces images in realistic and true colors. If you prefer images with that quality, select **On**. If you don't need it, select **Off**.

Selecting a Color Temperature

Select **Color Temperature** in the **Advanced menu > Picture > Advanced...** menu and adjust the values by pressing ◀/▶ on the projector or remote control.

There are several color temperature settings available.

1. Lamp Native: With the lamp's original color temperature and higher brightness. This setting is suitable for environments where high brightness is required, such as projecting pictures in well lit rooms.
2. Warm: Makes pictures appear reddish white.
3. Normal: Maintains normal colorings for white.
4. Cool: Makes pictures appear bluish white.

***About color temperatures:**

There are many different shades that are considered to be "white" for various purposes. One of the common methods of representing white color is known as the "color temperature". A white color with a low color temperature appears to be reddish white. A white color with a high color temperature appears to have more blue in it.

Setting a preferred color temperature

Select **Color Temperature Fine Tuning** in the **Advanced menu > Picture > Advanced...** menu and press **OK** on the projector or remote control.

1. Select **Color Temperature** and select Cool, Normal, Lamp Native or Warm by pressing **◀/▶** on the projector or remote control.
2. Got to **Advanced... > Color Temperature Fine Tuning** and press **OK** on the projector or remote control.
3. Press **▲/▼** to select the item you want to change and adjust the values by pressing **◀/▶**.
 - **R Gain/G Gain/B Gain: Adjusts the contrast levels of Red, Green, and Blue.**
 - **R Offset/G Offset/B Offset: Adjusts the brightness levels of Red, Green, and Blue.**
4. Press **MENU** on the projector or remote control to exit and save the settings.

Color Management

In most installation situations, color management will not be necessary, such as in classroom, meeting room, or lounge room situations where lights remain on, or where building external windows allow daylight into the room.

Only in permanent installations with controlled lighting levels such as boardrooms, lecture theaters, or home theaters, should color management be considered. Color management provides fine color control adjacent to allow for more accurate color reproduction, should you require it.

Proper color management can only be achieved under controlled and reproducible viewing conditions. You will need to use a colorimeter (color light meter), and provide a set of suitable source images to measure color reproduction. These tools are not provided with the projector, however, your projector supplier should be able to provide you with suitable guidance, or even an experienced professional installer.

The **Color Management** provides six sets (RGBCMY) of colors to be adjusted. When you select each color, you can independently adjust its range and saturation according to your preference.

If you have purchased a test disc which contains various color test patterns and can be used to test the color presentation on monitors, TVs, projectors, etc. You can project any image from the disc on the screen and enter the **Color Management** menu to make adjustments.

To adjust the settings:

1. Go to the **Advanced menu > Picture > Advanced...** menu and select **Color Management**.
2. Press **OK** on the projector or remote control and the **Color Management** page displays.
3. Select Primary Color and press **◀/▶** to select a color from among Red, Yellow, Green, Cyan, Blue, or Magenta.

4. Press ▼ to select Hue and press ◀/▶ to select its range. Increase in the range will include colors consisted of more proportions of its two adjacent colors. Please refer to the illustration to the right for how the colors relate to each other. For example, if you select Red and set its range at 0, only pure red in the projected picture will be selected. Increasing its range will include red close to yellow and red close to magenta.

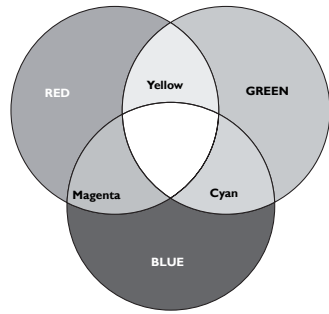

5. Press ▼ to select Gain and adjust its values to your preference by pressing ◀/▶. The contrast level of the primary color you select will be affected. Every adjacent made will reflect to the image immediately.
6. Press ▼ to select Saturation and adjust its values to your preference by pressing ◀/▶. Every adjacent made will reflect to the image immediately. For example, if you select Red and set its value at 0, only the saturation of pure red will be affected.



• **Saturation** is the amount of that color in a video picture. Lower settings produce less saturated colors; a setting of “0” removes that color from the image entirely. If the saturation is too high, that color will be overpowering and unrealistic.

7. Repeat steps 3 to 6 for other color adjustents.
8. Make sure you have made all of the desired adjustents.
9. Press **MENU** on the projector or remote control to exit and save the settings.

Reducing Noise Reduction

Reduces electrical image noise caused by different media players. The higher the setting, the less the noise.

Select **Noise Reduction** in the **Advanced menu > Picture > Advanced...** menu and press ◀/▶ to adjust the value from 0 to 31.

Selecting a Film Mode

Select **Film Mode** in the **Advanced menu > Picture > Advanced...** menu and select by pressing ◀/▶ on the projector or remote control.

On is the default and recommended selection for this projector. When **Off** is selected, the **Film Mode** function is not available.

This function is only available when Video or S-Video with NTSC system is selected.

Hiding the image

Press the **ECO BLANK** button from remote control to turn off the image for a period of time with up to 70% lamp power saving. Press any key on the projector or remote control to restore the image.

The word "**Eco Blank**" appears at the screen while the image is hidden. When this function is activated with an audio input connected, the audio can still be heard.

'Eco Blank: Save up 70% of your lamp power. Time to do your part in saving the planet.'

The automatic switch to **Eco Blank** mode after the projector is turned on for over three minutes without a display source, eliminating unnecessary energy waste and prolonging the life of the projector lamp.



Operating in a high altitude environment

We recommend you use the **High Altitude Mode** when your environment is between 1500 m –3000 m above sea level, and ambient temperature is between 0°C–35°C.

⚠ **Do not use the High Altitude Mode if your altitude is between 0 m and 1500 m and ambient temperature is between 0°C and 35°C. The projector will be over cooled, if you turn the mode on under such a condition.**

To activate the **High Altitude Mode**:

1. Open the OSD menu and make sure the **Menu Type** is **Advanced**.
2. Go to the **System Setup: Advanced > High Altitude Mode** and press ◀ / ▶ to select **On**. A confirmation message displays..
3. Select **Yes** and press **OK** on the projector or remote control.

Operation under "**High Altitude Mode**" may cause a higher decibel operating noise level because of increased fan speed necessary to improve overall system cooling and performance.

If you use this projector under other extreme conditions excluding the above, it may display auto shut-down symptoms, which is designed to protect your projector from over-heating. In cases like this, you should switch to **High Altitude Mode** to solve these symptoms. However, this is not to state that this projector can operate under any and all harsh or extreme conditions.

Adjusting the sound

The sound adjustments made as below will have an effect on the projector speaker(s). Be sure you have made a correct connection to the projector audio input. See "Connection" on page 19 for how the audio input is connected.

Muting the sound

To adjust the sound level, press  on the remote control, or:

1. Open the OSD menu and go to the **Audio Setup** menu (which is in the **Basic menu** or in the **Advanced menu > Audio Setup** menu).
2. Select **Mute** and select **On**.



Adjusting the sound level

To adjust the sound level, press  on the remote control, or:

1. Repeat steps 1 above.
2. Select **Volume** and select a desired sound level.

Turning off the Power On/Off Ring Tone

To turn off the ring tone:

1. Go to the **Advanced menu > Audio Setup** menu.
2. Select **Power On/Off Ring Tone** and select **Off**.

 **The only way to change Power On/Off Ring Tone is setting On or Off here. Setting the sound mute or changing the sound level will not affect the Power on/off ring tone.**

Adjusting the microphone's sound level

To adjust the sound level:



1. Go to the **Advanced menu > Audio Setup** menu.
2. Select **Microphone Volume** and select a desired sound level.

 **Microphone sound will still function even though Mute is activated.**

Locking control keys

With the control keys on the remote control and projector locked, you can prevent your projector settings from being changed accidentally (by children, for example). When **Key Lock** is **On**, no control keys on the remote control and projector will operate except **POWER** and .

To lock the keys:

1. Open the OSD menu and go to the **Advanced menu > System Setup: Advanced > Key Lock**.
2. Press  /  to select **On**. A warning message appears. Select **Yes** and press **OK** on the projector or remote control. The control keys lock.

To unlock the keys, press and hold  on the projector or remote control for 3 seconds.

Personalizing the projector menu display

The On-Screen Display (OSD) menus can be set according to your preferences. The following settings do not affect the projection settings, operation, or performance.

- **Language** in the **Advanced menu > System Setup: Basic** menu sets your familiar language for the OSD menus. Press **OK** on the projector or remote control to display language page. Use **▲/▼/◀/▶** and **OK** on the projector or remote control to select your language.
- **Menu Type** in the **Basic menu** or in the **Advanced menu > System Setup: Basic > Menu Settings** menu sets the menu type. Use **◀/▶** to select a preferred type.
- **Menu Position** in the **Advanced menu > System Setup: Basic > Menu Settings** menu sets the OSD position in five locations. Use **◀/▶** to select a preferred position.
- **Menu Display Time** in the **Advanced menu > System Setup: Basic > Menu Settings** menu sets the length of time the OSD will remain active after your last key press. The time length ranges from 5 to 20 seconds in 5-second increments. Use **◀/▶** to select a suitable time frame.
- **Blank Reminder Message** in the **Advanced menu > System Setup: Basic > Menu Settings** menu sets whether to display reminder messages on screen. Use **◀/▶** to select your desired setting.
- **Splash Screen** in the **Advanced menu > System Setup: Basic** menu sets a preferred logo screen to be displayed during projector start-up. Use **◀/▶** to select a screen.

Select the lamp saver mode

1. Open the OSD menu and go to the **Advanced menu > Picture > Lamp Power** menu.
2. Press **◀/▶** to select Normal/Economic/SmartEco. The lamp brightness vary from the different lamp mode, see the description list in table below.

Lamp Power	Description
Normal	Provides full lamp brightness
Economic	Lower brightness to extend the lamp life and decreases the fan noise
SmartEco	Adjusts the lamp power automatically depending on the content brightness level

 If the **Economic mode** or **SmartEco mode** is selected, the light output will be reduced and result in darker projected pictures.

Shutting down the projector

1. Press **POWER** on the projector. A confirmation message displays prompting you.
If you don't respond in a few seconds, the message will disappear. If you use the remote control, press **OFF** to shut down the projector.

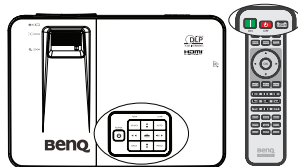

2. Press **POWER** on the projector a second time. The **POWER indicator light** flashes orange, the projection lamp shuts down, and the fans will continue to run to cool down the projector.

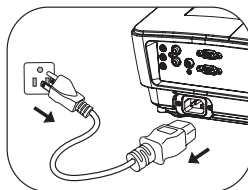

- **To protect the lamp, the projector will not respond to any commands during the cooling process.**
- **To shorten the cooling time, you can also activate the Quick Cooling function in the Advanced menu > System Setup: Advanced menu. See "Quick Cooling" on page 58 for details. Be aware that enabling the Quick Cooling function will affect the lamp life.**

3. Once the cooling process finishes, the **POWER indicator light** is a steady orange and fans stop.
4. Disconnect the power cord from the power outlet if the projector will not be used in an extended period of time.



- **If the projector is not properly shut down, to protect the lamp, when you attempt to re-start the projector, the fans will run for a few minutes to cool down. Press POWER on the projector again or ON on the remote control to start the projector after the fans stop and the POWER indicator light turns orange.**
- **Actual lamp lives may vary due to different environmental conditions and usage.**
- **If the projector is not properly shut down, it will damage the lamp and cause an effect on lamp life and brightness.**

Menu operation

Menu system

Please note that the on-screen display (OSD) menus vary according to the signal type selected.

	Basic menu	Sub-menu	Options
Without signal		Wall Color Correction	Off /Light Yellow/Pink/Light Green/Blue
		Projector Position	Front /Front Ceiling/Rear/Rear Ceiling
		Test Pattern	Off /On
		Auto Source	On /Off
		Menu Type	Basic /Advanced
		HDMI Format	Auto /PC Signal/Video Signal
		Reset Lamp Timer	Reset/ Cancel
		Reset All Settings	Reset/ Cancel
			Source
			Picture Mode
			Resolution
		Information	Color System
			Lamp Usage Time
		3D Format	
		Firmware Version	
With signal		Picture Mode	Bright/Vivid/Cinema/Game/User 1/User 2
		Volume	
		Mute	Off /On
		3D Mode	Auto /3D Off/Frame Sequential/Frame Packing/Top-Bottom/Side-by-Side
		3D Sync Invert	Disable /Invert
		Settings	Refer to without signal menus above.

 Supported functions in each **Advanced** menu vary by different input sources. The un-supported functions will be gray out.

Advanced menu	Sub-menu	Options
Picture	Picture Mode	Bright/Vivid/Cinema/Game/User 1/User 2
	User Mode Management	Load Settings From Rename User Mode
	Brightness	
	Contrast	
	Color	
	Tint	
	Sharpness	
	Color Temperature	Warm/Normal/Cool/Lamp Native
	Lamp Power	Normal/Economic/SmartEco
	Black Level	0 IRE/7.5 IRE
	Gamma Selection	1.6/ 1.8/ 2.0/ 2.1/ 2.2/2.3/ 2.4/ 2.6/ 2.8/BenQ
	Brilliant Color	On/Off
	Color Temperature Fine Tuning	Red Gain/Green Gain/Blue Gain/Red Offset/Green Offset/Blue Offset
	Advanced...	Primary Color
	Color Management	Hue Gain Saturation
	Noise Reduction	
	Film Mode	On/Off
	Reset Current Picture Mode	Reset/ Cancel

Audio Setup	Mute	Off/On	
	Volume		
	Microphone Volume		
	Power On/Off Ring Tone	On/Off	
	Reset Audio Settings	Reset/Cancel	
Display	Aspect Ratio	Auto /4:3 /16:9/Wide/Letter Box	
	Wall Color Correction	Off/Light Yellow/Pink/Light Green/Blue	
	Image Position		
	Overscan Adjustment		
	PC & Component YPbPr Tuning		H. Size
			Phase
			Auto (Only for RGBHD PC Timing)
	3D	3D Mode	Auto/3D Off/Frame Sequential/Frame Packing/Top-Bottom/Side-by-Side
3D Sync Invert		Disable/Invert	

System Setup: Basic	Language	English / Français / Deutsch Italiano / Español / Русский 繁體中文 / 简体中文 / 日本語 / 한국어 / Svenska / Nederlands / Türkçe / Čeština / Português / हिन्दी / Polski Magyar / Български / Hrvatski / Română / Suomi / Norsk / Dansk /Indonesian/Ελληνικά/ العربية / हिन्दी	
	Background Color	Black/Blue/Purple	
	Splash Screen	BenQ/Black/Blue	
	Projector Position	Front/Front Ceiling/Rear/Rear Ceiling	
	Auto Power Off	Disable/5 min/10 min/15 min/ 20 min/25 min/30 min	
	Direct Power On	Off/On	
	Menu Settings	Menu Type	Basic/Advanced
		Menu Position	Center/Top-Left/Top-Right/Bottom-Right/Bottom-Left
		Menu Display Time	Always On/5 secs/10 secs/15 secs/20 secs
		Blank Reminder Message	Off/On
	Source Rename		
	Auto Source	Off/On	

		Reset Lamp Timer	Yes/ No	
	Lamp Settings	Lamp Timer	Lamp Usage Time	
			Equivalent Lamp Hour	
	HDMI Format	Auto/PC Signal/Video Signal		
	Baud Rate	2400/4800/9600/14400/19200/ 38400/57600/115200		
	Test Pattern	Off/On		
System Setup: Advanced	Closed Caption	Closed Caption Enable	On/ Off	
		Caption Version	CC1/CC2/CC3/CC4	
	Quick Cooling	Off/On		
	High Altitude Mode	On/ Off	Yes/ No	
	Password	Change Password		
		Power On Lock	On/ Off	
	Key Lock	Off/On	Yes/ No	
	Reset All Settings	Reset/ Cancel		
	Information	Source		
		Picture Mode		
Resolution				
Color System				
Lamp Usage Time				
3D Format				
Firmware Version				

Note that the menu items are available when the projector detects at least one valid signal. If there is no equipment connected to the projector or no signal detected, limited menu items are accessible.

Description of each menu

- ☞ The default values listed in this manual, especially on pages 51-59, are for reference only. They may vary between the projectors due to the continuous improvement to the products.



FUNCTION	DESCRIPTION
Wall Color Correction	Corrects the projected picture's color when the projection surface is not white. See " Using Wall Color Correction " on page 37 for details.
Projector Position	The projector can be installed on a ceiling or behind a screen, or with one or more mirrors. See " Choosing a location " on page 15 for details.
Test Pattern	Selecting On enables the function and the projector displays the grid test pattern. It helps you adjust the image size and focus and check that the projected image is free from distortion.
Auto Source	See " Switching input signal " on page 33 for details.
Menu Type	Selects a Basic or Advanced menu type.
HDMI Format	Selects an appropriate HDMI format automatically or manually.
Reset Lamp Timer	See " Resetting the lamp timer " on page 66 for details.
Reset All Settings	Returns all settings to the factory preset values. ☞ The following settings will still remain: Rename User Mode, Language, Projector Position, Source Rename, Test Pattern, High Altitude Mode, Password and Key Lock.
Information	Source Shows the current signal source.
	Picture Mode Shows the selected mode in the Picture menu.
	Resolution Shows the native resolution of the input signal.
	Color System Shows input system format, NTSC, PAL, SECAM, or RGB.
	Lamp Usage Time Displays the number of hours the lamp has been used.
	3D Format Shows the current 3D mode.
	Firmware Version Shows firmware version.

Basic menu (without signal)

		FUNCTION	DESCRIPTION
Basic menu (with signal)		Picture Mode	Pre-defined picture modes are provided so you can optimize your projector image set-up to suit your program type. See " Selecting a picture mode " on page 36 for details.
		Volume	See " Adjusting the sound " on page 43 for details.
		Mute	See " Muting the sound " on page 43 for details.
		3D Mode	<p>This projector features a 3D function which enables you to enjoy the 3D movies, videos, and sporting events in a more realistic way by presenting the depth of the images. You need to wear a pair of 3D glasses to view the 3D images. See 3D User Manual for details.</p> <p> When the 3D Mode function is enabled:</p> <ul style="list-style-type: none"> • The brightness level of the projected image will decrease. • The Picture Mode cannot be adjusted.
		3D Sync Invert	When your 3D image is distorted, you can enable this function to switch between the image for the left eye and the right eye for the more comfortable 3D viewing experience.
		Settings	See " Basic menu (without signal) " on page 51 for details.



FUNCTION	DESCRIPTION
Picture Mode	Pre-defined picture modes are provided so you can optimize your projector image set-up to suit your program type. See "Selecting a picture mode" on page 36 for details.
User Mode Management	Selects a picture mode that best suits your need for the image quality and further fine-tune the image based on the selections listed on the same page below. See "Setting the User 1/User 2 mode" on page 36 for details.  This function is only available when User 1 or User 2 is selected.
Brightness	Adjusts the brightness of the image. See "Adjusting Brightness" on page 38 for details.
Contrast	Adjusts the degree of difference between dark and light in the image. See "Adjusting Contrast" on page 38 for details.
Color	Adjusts the color saturation level -- the amount of each color in a video image. See "Adjusting Color" on page 38 for details.
Tint	Adjusts the red and green color tones of the image. See "Adjusting Tint" on page 38 for details.
Sharpness	Adjusts the image to make it look sharper or softer. See "Adjusting Sharpness" on page 38 for details.
Color Temperature	See "Selecting a Color Temperature" on page 39 for details.
Lamp Power	See "Setting Lamp Power" on page 61 for details.
Advanced...	<p>Black Level See "Setting Black Level" on page 39 for details.</p> <p>Gamma Selection See "Selecting a Gamma Selection" on page 39 for details.</p> <p>Brilliant Color See "Adjusting Brilliant Color" on page 39 for details.</p> <p>Color Temperature Fine Tuning See "Setting a preferred color temperature" on page 40 for details.</p> <p>Color Management See "Color Management" on page 40 for details.</p> <p>Noise Reduction See "Reducing Noise Reduction" on page 41 for details.</p> <p>Film Mode See "Selecting a Film Mode" on page 41 for details.</p>
Reset Current Picture Mode	See "Resetting current picture mode" on page 37 for details.

	FUNCTION	DESCRIPTION
Advanced menu: Audio Setup	Mute	See " Muting the sound " on page 43 for details.
	Volume	See " Adjusting the sound " on page 43 for details.
	Microphone Volume	See " Adjusting the sound " on page 43 for details.
	Power On/Off Ring Tone	See " Adjusting the microphone's sound level " on page 43 for details.
	Reset Audio Settings	Returns Audio Setup menu to the factory preset values.

FUNCTION	DESCRIPTION
Aspect Ratio	There are four options to set the image's aspect ratio depending on your input signal source. See "Selecting the aspect ratio" on page 34 for details.
Wall Color Correction	Corrects the projected picture's color when the projection surface is not white. See "Using Wall Color Correction" on page 37 for details.
Image Position	<p>Displays the position adjacent page. To move the projected image, use the directional arrow keys. The values shown on the lower position of the page change with every key press you made until they reach their maximum or minimum.</p> <p> This function is only available when a PC signal (analog RGB) is selected.</p>
Overscan Adjustment	Removes the noise in a video image. Overscans the image to remove video encoding noise on the edge of video source.
PC & Component YPbPr Tuning	Corrects the display data frequency, phase, the position of the image and selects the preferred SOG level automatically or manually.
3D	<p>3D Mode</p> <p>This projector features a 3D function which enables you to enjoy the 3D movies, videos, and sporting events in a more realistic way by presenting the depth of the images. You need to wear a pair of 3D glasses to view the 3D images. See 3D User Manual for details.</p> <p> When the 3D Mode function is enabled:</p> <ul style="list-style-type: none"> • The brightness level of the projected image will decrease. • The Picture Mode cannot be adjusted. <p>3D Sync Invert</p> <p>When your 3D image is distorted, you can enable this function to switch between the image for the left eye and the right eye for the more comfortable 3D viewing experience.</p>

FUNCTION	DESCRIPTION
Language	Sets the language for the On-Screen Display (OSD) menus.
Background Color	Allows you to select which background color will display when no signal is input into the projector. Four options are available: Black, Blue, or Purple.
Splash Screen	Allows you to select which logo screen will display during projector start-up. Four options are available: BenQ logo, Black, or Blue.
Projector Position	The projector can be installed on a ceiling or behind a screen, or with one or more mirrors. See " Choosing a location " on page 16 for details.
Auto Power Off	Allows the projector to turn off automatically if no input signal is detected after a set period of time. See " Setting Auto Power Off " on page 62 for details.
Direct Power On	Selecting On enables the function. See " Starting up the projector " on page 24 for details.
Menu Settings	<p>Menu Type Selects a preferred menu type.</p> <p>Menu Position Sets the On-Screen Display (OSD) menu position.</p> <p>Menu Display Time Sets the length of time the OSD will remain active after your last key press. The range is from 5 to 20 seconds in 5-second increments.</p> <p>Blank Reminder Message Sets whether to display the reminder message.</p>
Source Rename	See " Renaming user modes " on page 37 for details.
Auto Source	See " Switching input signal " on page 33 for details.

FUNCTION	DESCRIPTION
Advanced menu: System Setup: Advanced	<p>Reset Lamp Timer See "Resetting the lamp timer" on page 63 for details.</p> <p>Lamp Settings</p> <p>Lamp Timer See "Getting to know the lamp hour" on page 59 for details on how the total lamp hour is calculated.</p>
	<p>HDMI Format Selects appropriate HDMI format automatically or manually.</p>
	<p>Baud Rate Selects a baud rate that is identical with your computer's so that you can connect the projector using a suitable RS-232 cable. This function is intended for qualified service personnel.</p>
	<p>Test Pattern Selecting On enables the function and the projector displays the grid test pattern. It helps you adjust the image size and focus and check that the projected image is free from distortion.</p>
	<p>Closed Caption Enable Activates the function by selecting On when the selected input signal carries closed captions.</p> <ul style="list-style-type: none"> • Captions: An on-screen display of the dialogue, narration, and sound effects of TV programs and videos that are closed captioned (usually marked as "CC" in TV listings). <p> To achieve the best performance of the Closed Caption, set your screen aspect ratio to 4:3.</p> <p>Caption Version Selects a preferred closed captioning mode. To view captions, select CC1, CC2, CC3, or CC4 (CC1 displays captions in the primary language in your area).</p>

FUNCTION	DESCRIPTION
Advanced menu: System Setup: Advanced	<p>Selecting On enables the function and the projector cooling time will be shortened to a few seconds.</p> <p> If you attempt to restart the projector right after the quick cooling process, it may not be turned on successfully and will rerun its cooling fans.</p>
	<p>High Altitude Mode</p> <p>A mode for operation in high altitude areas. See "Operating in a high altitude environment" on page 42 for details.</p>
	<p>Change Password</p> <p>You will be asked to enter the current password before changing to a new one.</p> <p>Power On Lock</p> <p>See "Securing the projector" on page 31 for details.</p>
	<p>Key Lock</p> <p>Disables or enables all panel key functions except Power on the projector and keys on the remote control.</p>
	<p>Reset All Settings</p> <p> The following settings will still remain: Rename User Mode, Language, Projector Position, Source Rename, Test Pattern, High Altitude Mode, Password and Key Lock.</p>

		FUNCTION	DESCRIPTION
Advanced menu: Information		Source	Shows the current signal source.
		Picture Mode	Shows the selected mode in the Picture menu.
		Resolution	Shows the native resolution of the input signal.
		Color System	Shows input system format, NTSC, PAL, SECAM, or RGB.
		Lamp Usage Time	Displays the number of hours the lamp has been used.
		3D Format	Shows the current 3D mode.
		Firmware Version	Shows firmware version.

Maintenance

Care of the projector

Your projector needs little maintenance. The only thing you need to do on a regular basis is to keep the lens and case clean.

Never remove any parts of the projector except the lamp. Contact your dealer if other parts need replacing.

Cleaning the lens

Clean the lens whenever you notice dirt or dust on the surface.

- Use a canister of compressed air to remove dust.
- If there is dirt or smears, use lens-cleaning paper or moisten a soft cloth with lens cleaner and gently wipe the lens surface.
- Never use any type of abrasive pad, alkaline/acid cleaner, scouring powder, or volatile solvent, such as alcohol, benzene, thinner or insecticide. Using such materials or maintaining prolonged contact with rubber or vinyl materials may result in damage to the projector surface and cabinet material.

 **Never rub the lens with abrasive materials.**

Cleaning the projector case

Before you clean the case, turn the projector off using the proper shutdown procedure as described in ["Shutting down the projector" on page 45](#) and unplug the power cord.

- To remove dirt or dust, wipe the case with a soft, lint-free cloth.
- To remove stubborn dirt or stains, moisten a soft cloth with water and a neutral pH detergent. Then wipe the case.

 **Never use wax, alcohol, benzene, thinner or other chemical detergents. These can damage the case.**

Storing the projector

If you need to store the projector for an extended time, please follow the instructions below:

- Make sure the temperature and humidity of the storage area are within the recommended range for the projector. Please refer to ["Specifications" on page 70](#) or consult your dealer about the range.
- Retract the adjuster feet.
- Remove the battery from the remote control.
- Pack the projector in its original packing or equivalent.

Transporting the projector

It is recommended that you ship the projector with its original packing or equivalent.

Lamp information

Getting to know the lamp hour

When the projector is in operation, the duration (in hours) of lamp usage is automatically calculated by the built-in timer. The method of calculating the equivalent lamp hour is as follows:

Total (equivalent) lamp hour
= 1 (hours used in Economic mode) + 4/3 (hours used in normal mode)

☞ See "[Setting Lamp Power](#)" below for more information on Economic mode.

The lamp hour in Economic mode is calculated as 3/4 of that in Normal mode. That is, using the projector in Economic mode helps to extend the lamp hour by 1/3.

To obtain the lamp hour information:

1. Open the OSD menu and go to the **Advanced menu > System Setup: Advanced > Lamp Settings** menu. Press **OK** on the projector or remote control.
2. Select **Lamp Timer** and press **OK** on the projector or remote control.
3. You will see the **Equivalent Lamp Hour** information displaying on the menu.
4. To leave the menu, press **MENU** on the projector or remote control.

You can also get the lamp hour information on the **Information** menu.

Extending lamp life

The projection lamp is a consumable item. To keep the lamp life as long as possible, you can do the following settings via the OSD menu or remote control.

Setting Lamp Power

Using **Economic/SmartEco** mode will reduce system noise and power consumption. If the **Economic/SmartEco** mode is selected, the light output will be reduced and result in darker projected pictures, the projector protected for longer working life.

Setting the projector in **Economic/SmartEco** mode also extends the lamp operation life. To set **Economic/SmartEco** mode, go to the **Advanced menu > Picture > Lamp Power** menu and press **◀/▶**.

The lamp modes are defined as the chart below:

Lamp Power	Description
Normal	Provides full lamp brightness
Economic	Lower brightness to extend the lamp life and decreases the fan noise
SmartEco	Adjusts the lamp power automatically depending on the content brightness level

Setting Auto Power Off

This function allows the projector to turn off automatically if no input source is detected after a set period of time to prevent unnecessary waste of lamp life.

To set **Auto Power Off**, go to the **Advanced menu > System Setup: Basic > Auto Power Off** menu and press ◀/▶. The time period can be set from 5 to 30 minutes in 5-minute increments. If the preset time lengths are not suitable for your presentation, select **Disable**. The projector will not automatically shut down in a certain time period.



Timing of replacing the lamp

When the Lamp indicator lights up red or a message appears suggesting it is time to replace the lamp, please install a new lamp or consult your dealer. An old lamp may cause a malfunction in the projector and in some instances the lamp may explode.

 **The Lamp indicator light and Temperature warning light will light up if the lamp becomes too hot. See "Indicators" on page 67 for details.**

The following lamp warning displays will remind you to change the lamp.

 **The warning messages below are for reference only. Please follow the actual on-screen instructions to prepare and replace the lamp.**

Status	Message
<p>It is strongly recommended that you replace the lamp at this stage. The lamp is a consumable item. The lamp brightness diminishes with use. This is normal lamp behavior. You can replace the lamp whenever you notice that the brightness level has significantly diminished.</p>	
<p>The lamp MUST be replaced before the projector will operate normally.</p>	

Replacing the lamp (FOR SERVICE PERSONNEL ONLY)

- ⚠ • **Hg - Lamp contains mercury. Manage in accordance with local disposal laws. See www.lamprecycle.org.**
 - **If lamp replacement is performed while the projector is suspended upside-down from the ceiling, make sure that no one is underneath the lamp socket to avoid any possible injury or damage to the human eyes caused by fractured lamp.**
 - **To reduce the risk of electrical shock, always turn the projector off and disconnect the power cord before changing the lamp.**
 - **To reduce the risk of severe burns, allow the projector to cool for at least 45 minutes before replacing the lamp.**
 - **To reduce the risk of injuries to fingers and damage to internal components, use caution when removing lamp glass that has shattered into sharp pieces.**
 - **To reduce the risk of injuries to fingers and/or compromising image quality by touching the lens, do not touch the empty lamp compartment when the lamp is removed.**
 - **This lamp contains mercury. Consult your local hazardous waste regulations to dispose of this lamp in a proper manner.**
 - **To assure optimal performance from the projector, it is recommended that you purchase a BenQ projector lamp for lamp replacement.**
 - **Ensure good ventilation when handling broken lamps. We recommend that you use respirators, safety glasses, goggles or face shield and wear protective clothing such as gloves.**
1. **Turn the power off and disconnect the projector from the power outlet. If the lamp is hot, avoid burns by waiting for approximately 45 minutes until the lamp has cooled.**
 2. **Loosen the screw on the lamp cover.**

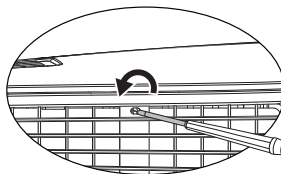

3. Remove the lamp cover by (a) pushing the lamp cover upward and (b) lifting it off.



- **Do not turn the power on with the lamp cover removed.**
- **Do not insert your fingers between the lamp and the projector. The sharp edges inside the projector may cause injuries.**

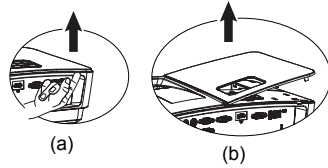

4. Loosen the screws that secure the lamp.

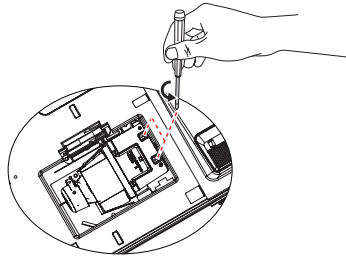

5. Lift the handle so that it stands up. Use the handle to slowly pull the lamp out of the projector.



- **Pulling it too quickly may cause the lamp to break and scatter broken glass in the projector.**
- **Do not place the lamp in locations where water might splash on it, children can reach it, or near flammable materials.**
- **Do not insert your hands into the projector after the lamp is removed. If you touch the optical components inside, it could cause color unevenness and distortion of the projected images.**

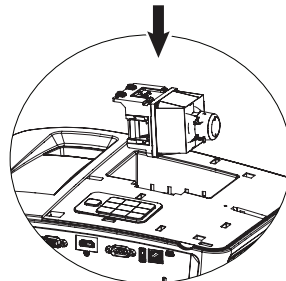
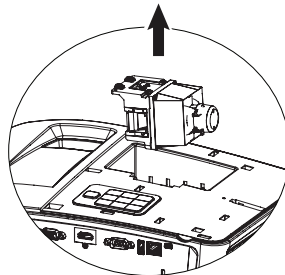

6. Insert the new lamp into the lamp compartment and make sure it fits in the projector.

7. Tighten the screws that secure the lamp.



• **Loose screw may cause a bad connection, which could result in malfunction.**

- **Do not over tighten the screws.**
8. Ensure the handle is fully laid flat and locked in place.
 9. Replace the lamp cover by sliding it into place.

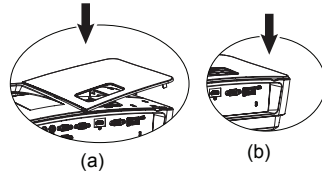
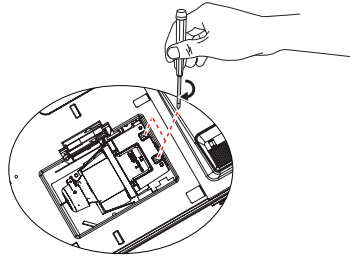

10. Tighten the screw that secures the lamp cover.



• **Loose screw may cause a bad connection, which could result in malfunction.**

- **Do not over tighten the screw.**

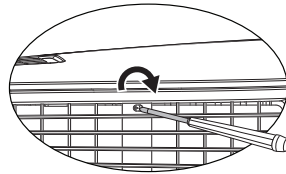

11. Restart the projector.



• **Do not turn the power on with the lamp cover removed.**

Resetting the lamp timer

12. After the startup logo, open the On-Screen Display (OSD) menu. Go to the **Advanced menu > System Setup: Advanced > Lamp Settings > Reset Lamp Timer** menu and press **OK** on the projector or remote control. A



warning message displays asking if you want to reset the lamp timer. Select **Reset** and press **OK** on the projector or remote control. The lamp time will be reset to '0'.



• **Do not reset if the lamp is not new or replaced as this could cause damage.**

Indicators

Light				Status & Description
POWER	TEMP	LAMP I	LAMP2	
Power events				
Orange	Off	Off	Off	Stand-by
Green Flashing	Off	Off	Off	Powering up
Green	Off	Off	Off	Normal operation
Orange Flashing	Off	Off	Off	Normal power-down cooling
Red Flashing	Red Flashing	Red Flashing	Off	Download
Green	Off	Red	Off	CW start fail
Red Flashing	Off	Off	Off	Scaler shutdown fail (data abort)
Red	Off	Red	Off	Scaler reset fail (video projector only)
Burn-in message				
Green	Off	Off		Burn-in ON
Green	Green	Green		Burn-in OFF
Lamp error messages				
Off	Off	Red	Off	Lamp I error in normal operation
Off	Off	Orange	Off	Lamp is not lit up
Thermal error messages				
Red	Red	Off	Off	Fan 1 error (the actual fan speed is $\pm 25\%$ outside the desired speed)
Red	Red Flashing	Off	Off	Fan 2 error (the actual fan speed is $\pm 25\%$ outside the desired speed)
Red	Green	Off	Off	Fan 3 error (the actual fan speed is $\pm 25\%$ outside the desired speed)
Green	Red	Off	Off	Temperature 1 error (over limited temperature)
Green	Red Flashing	Off	Off	Thermal Sensor 1 open error
Green	Green	Off	Off	Thermal Sensor 1 short error
Green	Green Flashing	Off	Off	Thermal IC #1 I2C Connection error
Green Flashing	Red	Off	Off	Temperature 2 error (over limited temperature)
Green Flashing	Red Flashing	Off	Off	Thermal Sensor 2 open error
Green Flashing	Green	Off	Off	Thermal Sensor 2 short error

Green Flashing	Green Flashing	Off	Off	Thermal IC #2 I2C Connection error
-----------------------	-----------------------	------------	------------	------------------------------------

Troubleshooting

? The projector does not turn on.

Cause	Remedy
There is no power from the power cable.	Plug the power cord into the AC inlet on the projector, and plug the power cord into the power outlet. If the power outlet has a switch, make sure that it is switched on.
Attempting to turn the projector on again during the cooling process.	Wait until the cooling down process has completed.

? No picture

Cause	Remedy
The video source is not turned on or connected correctly.	Turn the video source on and check that the signal cable is connected correctly.
The projector is not correctly connected to the input signal device.	Check the connection.
The input signal has not been correctly selected.	Select the correct input signal with the Source key on the projector or remote control.
The lens cover is still closed.	Open the lens cover.

? Blurred image

Cause	Remedy
The projection lens is not correctly focused.	Adjust the focus of the lens using the focus ring.
The projector and the screen are not aligned properly.	Adjust the projection angle and direction as well as the height of the unit if necessary.
The lens cover is still closed.	Open the lens cover.

? Remote control does not work

Cause	Remedy
The battery is out of power.	Replace the battery with new one.
There is an obstacle between the remote control and the projector.	Remove the obstacle.
You are too far away from the projector.	Stand within 12 meters (39 feet) of the projector.

? The password is incorrect

Cause	Remedy
You do not remember the password.	Please see " Entering the password recall procedure " on page 32 for details.

Specifications

 All specifications are subject to change without notice.

Optical

Resolution
1920x1080, 1080p
Display system
I-CHIP DMD
Lens F/Number
F= 2.55~2.79
f= 22.3mm~26.76mm
Offset
116%
Zoom ratio
1.2X
Lamp
210W

Electrical

Power supply
AC100~240V, 2.90 A,
50-60 Hz (Automatic)
Power consumption
270 W (Max.); < 0.5 W (Standby)

Mechanical

Weight
3.0 kg (6.6 lbs.)

Output terminals

Speaker
(Stereo) 10 watt x 1
Audio signal output
PC audio jack x 1

Control

IR receiver x 1 (front)
RS-232 serial control
9 pin x 1

USB

Mini B
Supports firmware upgrade
Type A
1.5A output

Input terminals

Computer input
RGB input
D-Sub 15-pin (female) x 2
Video signal input
VIDEO
RCA jack x 1
SD/HDTV signal input
Analog - Component RCA jack x 3
(through RGB input)
Digital-HDMI x 1
Audio signal input
PC audio jack x 1 for audio input
PC audio jack x 1 for microphone audio
input
RCA audio jack (L/R) x 2

Environmental Requirements

Operating temperature
0°C-40°C at sea level
Operating relative humidity
10%-90% (without condensation)
Operating altitude
0-1499 m at 0°C-35°C
1500-3000 m at 0°C-30°C (with High
Altitude Mode on)

 Lamp life results will vary depending on environmental conditions and usage.

Dimensions

327.3 mm (W) × 136.7 mm (H) × 232.8 mm (D)

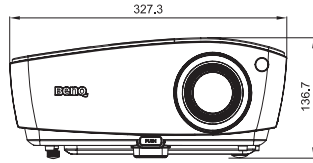
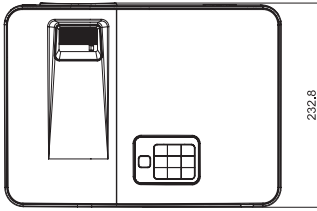

Ceiling mount installation

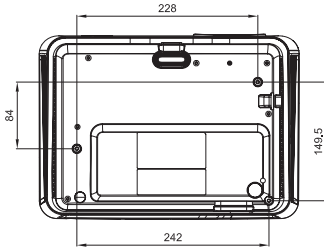

Ceiling mount screw: M4
(Max L = 25 mm; Min L = 20 mm)

Unit: mm

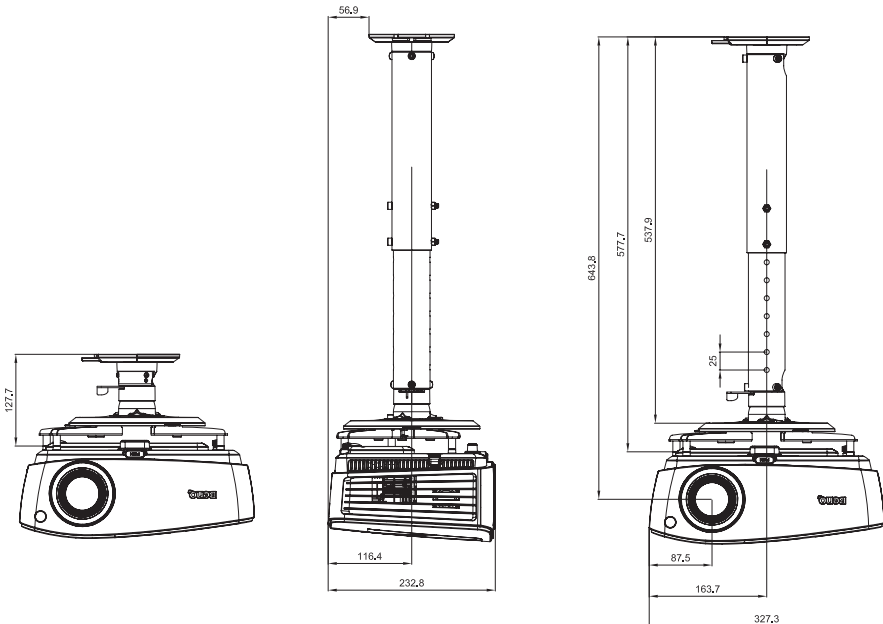

Timing chart

Supported timing for D-Sub input (PC signal)

Resolution	Timing	Horizontal Frequency (KHz)	Vertical Frequency (Hz)	Pixel Frequency (MHz)	3D Field Sequential	3D Top-Bottom	3D Side-by-Side
640 x 480	VGA_60	59.94	31.469	25.175	○	○	○
	VGA_72	72.809	37.861	31.500			
	VGA_75	75	37.5	31.500			
	VGA_85	85.008	43.269	36.000			
720 x 400	720 x 400_70	70.087	31.469	28.3221			
800 x 600	SVGA_60	60.317	37.879	40.000	○	○	○
	SVGA_72	72.188	48.077	50.000			
	SVGA_75	75	46.875	49.500			
	SVGA_85	85.061	53.674	56.250			
	SVGA_120 (Reduce Blanking)	119.854	77.425	83.000	○		
1024 x 768	XGA_60	60.004	48.363	65.000	○	○	○
	XGA_70	70.069	56.476	75.000			
	XGA_75	75.029	60.023	78.750			
	XGA_85	84.997	68.667	94.500			
	XGA_120 (Reduce Blanking)	119.989	97.551	115.5	○		
1152 x 864	1152 x 864_75	75	67.5	108			
1024 x 576	BenQ Notebook Timing	60	35.82	46.966			
1024 x 600	BenQ Notebook Timing	64.995	41.467	51.419			
1280 x 720	1280 x 720_60	60	45	74.250	○	○	○
	1280 x 720_120	120	90.000	148.500	○		
1280 x 768	1280 x 768_60	59.87	47.776	79.5	○	○	○
1280 x 800	WXGA_60	59.81	49.702	83.500	○	○	○
	WXGA_75	74.934	62.795	106.500			
	WXGA_85	84.88	71.554	122.500			
	WXGA_120 (Reduce Blanking)	119.909	101.563	146.25	○		
1280 x 1024	SXGA_60	60.02	63.981	108.000		○	○
	SXGA_75	75.025	79.976	135.000			
	SXGA_85	85.024	91.146	157.500			
1280 x 960	1280 x 960_60	60	60	108.000		○	○
	1280 x 960_85	85.002	85.938	148.500			
1360 x 768	1360 x 768_60	60.015	47.712	85.5		○	○
1440 x 900	WXGA+_60	59.887	55.935	106.500		○	○

1400 x 1050	SXGA+_60	59.978	65.317	121.750		⊙	⊙
1600 x 1200	UXGA	60	75	162.000		⊙	⊙
1680 x 1050	1680 x 1050_60	59.954	65.29	146.25		⊙	⊙
640 x 480 @67Hz	MAC13	66.667	35	30.240			
832 x 624 @75Hz	MAC16	74.546	49.722	57.280			
1024 x 768 @75Hz	MAC19	75.02	60.241	80.000			
1152 x 870 @75Hz	MAC21	75.06	68.68	100.000			

- The timings showing above may not be supported due to EDID file and VGA graphic card limitations. It is possible that some timings cannot be chosen.

Supported timing for HDMI (HDCP) input (PC signal)

Resolution	Timing	Horizontal Frequency (KHz)	Vertical Frequency (Hz)	Pixel Frequency (MHz)	3D Field Sequential	3D Top-Bottom	3D Side-by-Side
640 x 480	VGA_60	59.94	31.469	25.175	⊙	⊙	⊙
	VGA_72	72.809	37.861	31.500			
	VGA_75	75	37.5	31.500			
	VGA_85	85.008	43.269	36.000			
720 x 400	720 x 400_70	70.087	31.469	28.3221			
800 x 600	SVGA_60	60.317	37.879	40.000	⊙	⊙	⊙
	SVGA_72	72.188	48.077	50.000			
	SVGA_75	75	46.875	49.500			
	SVGA_85	85.061	53.674	56.250			
	SVGA_120 (Reduce Blanking)	119.854	77.425	83.000	⊙		
1024 x 768	XGA_60	60.004	48.363	65.000	⊙	⊙	⊙
	XGA_70	70.069	56.476	75.000			
	XGA_75	75.029	60.023	78.750			
	XGA_85	84.997	68.667	94.500			
	XGA_120 (Reduce Blanking)	119.989	97.551	115.5	⊙		
1152 x 864	1152 x 864_75	75	67.5	108			
1024 x 576	BenQ Notebook Timing	60	35.82	46.966			
1024 x 600	BenQ Notebook Timing	64.995	41.467	51.419			
1280 x 720	1280 x 720_60	60	45	74.250	⊙	⊙	⊙
1280 x 768	1280 x 768_60	59.87	47.776	79.5	⊙	⊙	⊙

1280 x 800	WXGA_60	59.81	49.702	83.500	⊙	⊙	⊙
	WXGA_75	74.934	62.795	106.500			
	WXGA_85	84.88	71.554	122.500			
	WXGA_120 (Reduce Blanking)	119.909	101.563	146.25	⊙		
1280 x 1024	SXGA_60	60.02	63.981	108.000		⊙	⊙
	SXGA_75	75.025	79.976	135.000			
	SXGA_85	85.024	91.146	157.500			
1280 x 960	1280 x 960_60	60	60	108.000		⊙	⊙
	1280 x 960_85	85.002	85.938	148.500			
1360 x 768	1360 x 768_60	60.015	47.712	85.5		⊙	⊙
1440 x 900	WXGA+_60	59.887	55.935	106.500		⊙	⊙
1400 x 1050	SXGA+_60	59.978	65.317	121.750		⊙	⊙
1600 x 1200	UXGA	60	75	162.000		⊙	⊙
1680 x 1050	1680 x 1050_60	59.954	65.29	146.25		⊙	⊙
640 x 480 @67Hz	MAC13	66.667	35	30.240			
832 x 624 @75Hz	MAC16	74.546	49.722	57.280			
1024 x 768 @75Hz	MAC19	75.02	60.241	80.000			
1152 x 870 @75Hz	MAC21	75.06	68.68	100.000			
1920 x 1080	1080_60 (Reduce Blanking)	67.5	60	148.5			
1920 x 1200	1920 x 1200_60 (Reduce Blanking)	59.95	74.038	154.000		⊙	⊙

The timings showing above may not be supported due to EDID file and VGA graphic card limitations. It is possible that some timings cannot be chosen.

Supported timing for HDMI (HDCP) input (Video signal)

Resolution	Timing	Horizontal Frequency (KHz)	Vertical Frequency (Hz)	Pixel Frequency (MHz)	3D Field Sequential	3D Frame Packing/	3D Top-Bottom	3D Side-by-Side
720 (1440) x 480	480i	15.73	59.94	27	⊙			
720 x 480	480p	31.47	59.94	27	⊙			
720 (1440) x 576	576i	15.63	50	27				
720 x 576	576p	31.25	50	27				
1280 x 720	720/50p	37.5	50	74.25		⊙	⊙	⊙
1280 x 720	720/60p	45.00	60	74.25	⊙	⊙	⊙	⊙
1920 x 1080	1080/24p	27	24	74.25		⊙	⊙	⊙
1920 x 1080	1080/25p	28.13	25	74.25				
1920 x 1080	1080/30p	33.75	30	74.25				
1920 x 1080	1080/50i	28.13	50	74.25				⊙
1920 x 1080	1080/60i	33.75	60	74.25				⊙
1920 x 1080	1080/50p	56.25	50	148.5			⊙	⊙

1920 x 1080	1080/60p	67.5	60	148.5			⊙	⊙
-------------	----------	------	----	-------	--	--	---	---

Supported 3D signal for Video input

Video mode	Horizontal Frequency (kHz)	Vertical Frequency (Hz)	Color sub-carrier Frequency (MHz)	3D Field Sequential
NTSC	15.73	60	3.58	⊙
PAL	15.63	50	4.43	
SECAM	15.63	50	4.25 or 4.41	
PAL-M	15.73	60	3.58	
PAL-N	15.63	50	3.58	
PAL-60	15.73	60	4.43	
NTSC4.43	15.73	60	4.43	

Supported timing for Component-YPbPr input

Timing	Resolution	Horizontal Frequency (KHz)	Vertical Frequency (Hz)	Pixel Frequency (MHz)	3D Field Sequential
480i	720 x 480	15.73	59.94	13.5	⊙
480p	720 x 480	31.47	59.94	27	⊙
576i	720 x 576	15.63	50	13.5	
576p	720 x 576	31.25	50	27	
720/50p	1280 x 720	37.5	50	74.25	
720/60p	1280 x 720	45.00	60	74.25	⊙
1080/50i	1920 x 1080	28.13	50	74.25	
1080/60i	1920 x 1080	33.75	60	74.25	
1080/24P	1920 x 1080	27	24	74.25	
1080/25P	1920 x 1080	28.13	25	74.25	
1080/30P	1920 x 1080	33.75	30	74.25	
1080/50P	1920 x 1080	56.25	50	148.5	
1080/60P	1920 x 1080	67.5	60	148.5	

Warranty and Copyright information

Patents

Please go to <http://patmarking.benq.com/> for the details on BenQ projector patent coverage.

Limited warranty

BenQ warrants this product against any defects in material and workmanship, under normal usage and storage.

Proof of purchase date will be required with any warranty claim. In the event this product is found to be defective within the warranty period, BenQ's only obligation and your exclusive remedy shall be replacement of any defective parts (labor included). To obtain warranty service, immediately notify the dealer from which you purchased the product of any defects.

Important: The above warranty shall be void if the customer fails to operate the product in accordance with BenQ's written instructions, especially the ambient humidity must be in-between 10% and 90%, temperature in-between 0°C and 35°C, altitude lower than 4920 feet, and avoiding to operate the projector in a dusty environment. This warranty gives you specific legal rights, and you may have other rights which vary from country to country.

For other information, please visit www.BenQ.com.

Copyright

Copyright 2015 by BenQ Corporation. All rights reserved. No part of this publication may be reproduced, transmitted, transcribed, stored in a retrieval system or translated into any language or computer language, in any form or by any means, electronic, mechanical, magnetic, optical, chemical, manual or otherwise, without the prior written permission of BenQ Corporation.

Disclaimer

BenQ Corporation makes no representations or warranties, either expressed or implied, with respect to the contents hereof and specifically disclaims any warranties, merchantability or fitness for any particular purpose. Further, BenQ Corporation reserves the right to revise this publication and to make changes from time to time in the contents hereof without obligation to notify any person of such revision or changes.

*DLP, Digital Micromirror Device and DMD are trademarks of Texas Instruments. Others are copyrights of their respective companies or organizations.