

# ViewSonic®

## *PJ1065*

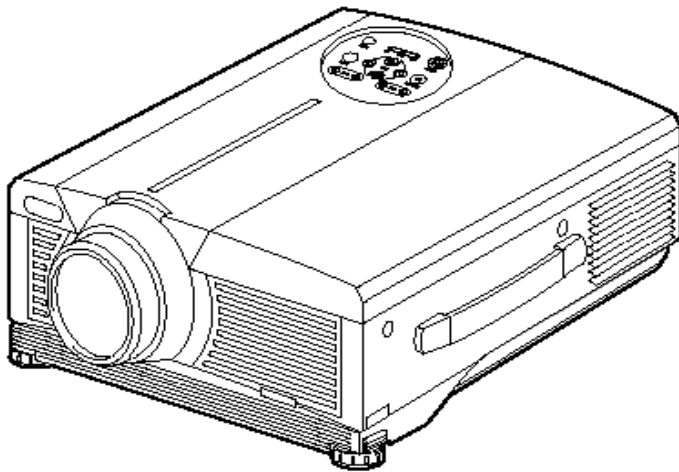

*Image Size 30" – 300"  
XGA LCD Projector*

User Guide

Guide de l'utilisateur

Bedienungsanleitung

Guía del usuario

Guida Dell'utente

Användarhandbok

Käyttöopas

使用者指南

使用者指南

# Contents

For Your Records .....	1
<b>FEATURES</b>	
<b>BEFORE USE</b>	
Contents of Package .....	2
Part Names .....	3
Inserting the Batteries .....	5
<b>INSTALLATION</b>	
Installation of the Projector and Screen .....	6
Angle Adjustment .....	6
Cabling .....	7
Power Connection .....	8
Example of System Setup .....	8
Plug & Play .....	8
<b>OPERATIONS</b>	
Power ON .....	9
Power OFF .....	9
Basic Operation .....	10
Setup Menu .....	12
Input Menu .....	13
Image Menu .....	14
Options Menu .....	15
No Signal Menu .....	16
<b>MAINTENANCE</b>	
Lamp .....	17
Air Filters .....	19
Other Maintenance .....	19
<b>TROUBLESHOOTING</b>	
OSD Message .....	20
Indicator Message .....	21
Symptom .....	22
Specifications .....	23
Customer Support .....	24
<b>LIMITED WARRANTY</b>	
VIEWSONIC Projector .....	25
<b>Appendix</b>	
Power Cord Safety Guidelines .....	26
FCC Information .....	27
Compliance Information for Canada .....	27
Compliance Information for European Countries .....	27
User Information for All Countries .....	27

Copyright © ViewSonic Corporation, 2002. All rights reserved.

Macintosh, Mac and Power Macintosh are registered trademarks of Apple Computer, Inc.

Microsoft, Windows, Windows NT, and the Windows logo are registered trademarks of Microsoft Corporation in the United States and other countries.

ViewSonic, the three birds logo and OnView are registered trademarks of ViewSonic Corporation.

VESA and SVGA are registered trademarks of the Video Electronics Standards Association. DPMS and DDC are trademarks of VESA.

VGA, and XGA are registered trademarks of the International Business Machines Corporation.

ENERGY STAR® is a registered trademark of the U.S. Environmental Protection Agency (EPA).

As an ENERGY STAR® partner, ViewSonic Corporation has determined that this product meets the ENERGY STAR® guidelines for energy efficiency.

Disclaimer: ViewSonic Corporation shall not be liable for technical or editorial errors or omissions contained herein; nor for incidental or consequential damages resulting from furnishing this material, or the performance or use this product.

In the interest of continuing product improvement, ViewSonic Corporation reserves the right to change product specifications without notice. Information in this document may change without notice.

No part of this document may be copied, reproduced, or transmitted by any means, for any purpose without prior written permission from ViewSonic Corporation.

### Electronic Warranty Registration

To meet your future needs, and to receive any additional product information as it becomes available, please register your projector's warranty on the Internet at:

**<http://www.viewsonic.com>**

Image Optimization files are also available free of charge at our web site. Go to [www.viewsonic.com](http://www.viewsonic.com) and select "Support." If you do not have access to the internet or if you require further assistance, contact "Customer Support" on page 24.

### For Your Records

<b>Product Name:</b>	<b>ViewSonic PJ1065</b>
<b>Model Number:</b>	<b>VPROJ24268-2W</b>
<b>Document Number</b>	<b>A-CD-PJ1065-2</b>
<b>Serial Number:</b>	_____
<b>Purchase Date:</b>	_____

### Product disposal at end of product life

ViewSonic is concerned about the preservation of our environment. Please dispose of this product properly at the end of its useful life. Your local waste disposal company may provide information about proper disposal.

# FEATURES

This liquid crystal projector is used to project various computer signals as well as NTSC/PAL/SECAM video signals onto a screen. The installation of this projector requires only a small space, and large images can be projected easily.

## Outstanding Brightness

The UHB lamp and the highly efficient optical system assure a high level of brightness.

## Function for Partial Magnification

Interesting parts of images can be magnified for a closer viewing.

## Function for Correcting Distortions

Distortion-free images can quickly be adjusted.

# BEFORE USE

## Contents of Package

Make sure all of the following items are included in the package. If anything is missing, please contact your dealer.

**NOTE:** Keep the original packing material for future shipment.

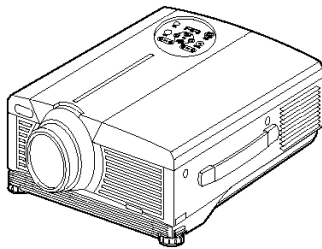

Projector

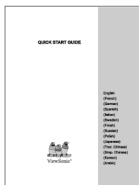

Quick Start Guide



CD-Wizard

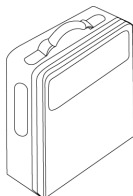

Carrying Case

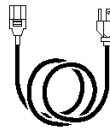

Power Cord  
(US)

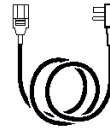

Power Cord  
(UK)

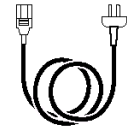

Power Cord  
(Europe)

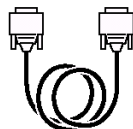

RGB Cable

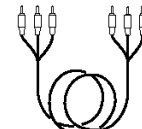

Component Video Cable

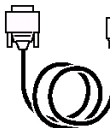

Mouse cable  
(PS/2)

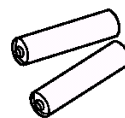

Batteries  
for Remote Control  
Device

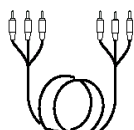

RCA Video/Audio  
Cable

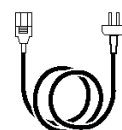

Power Cord  
(China)



Remote Control  
Device

# Part Names

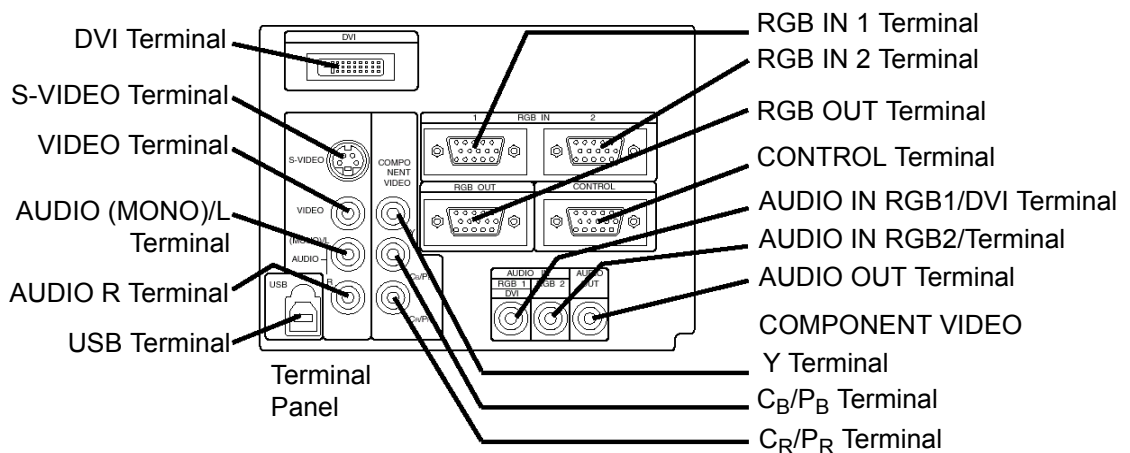
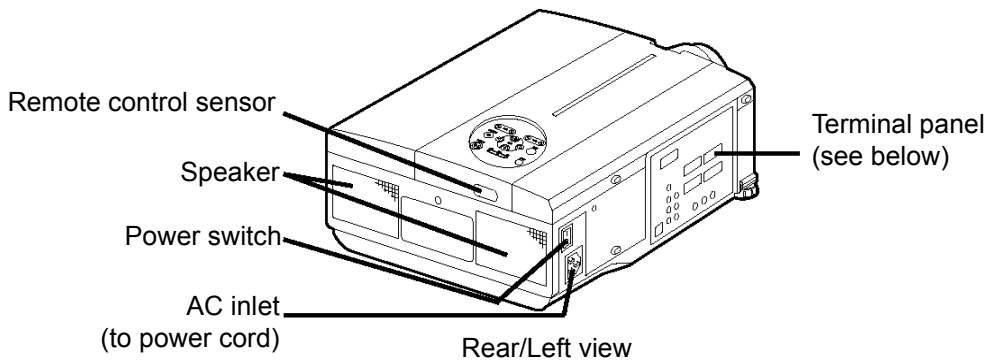
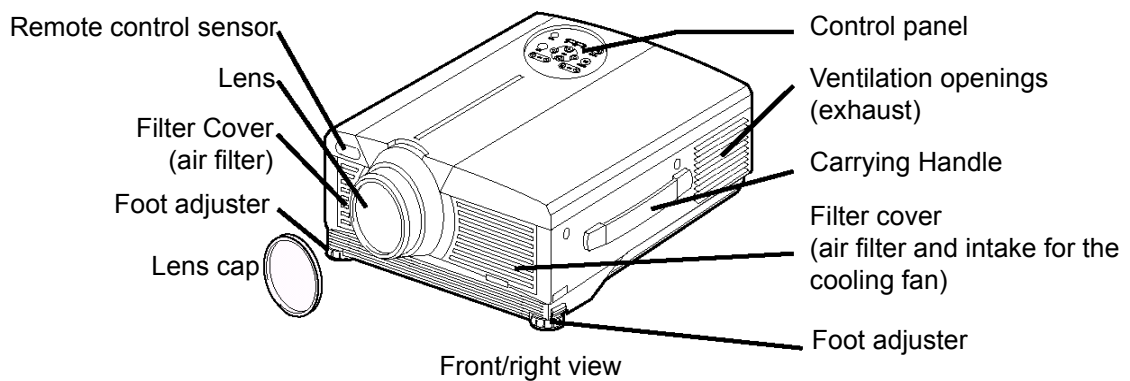
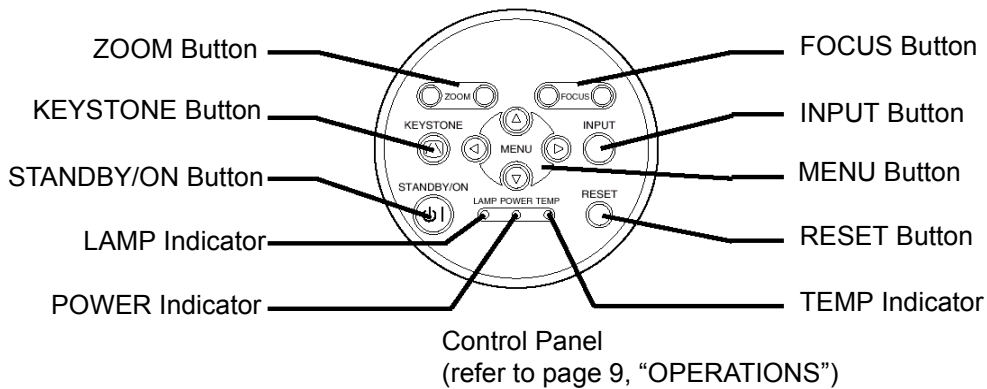

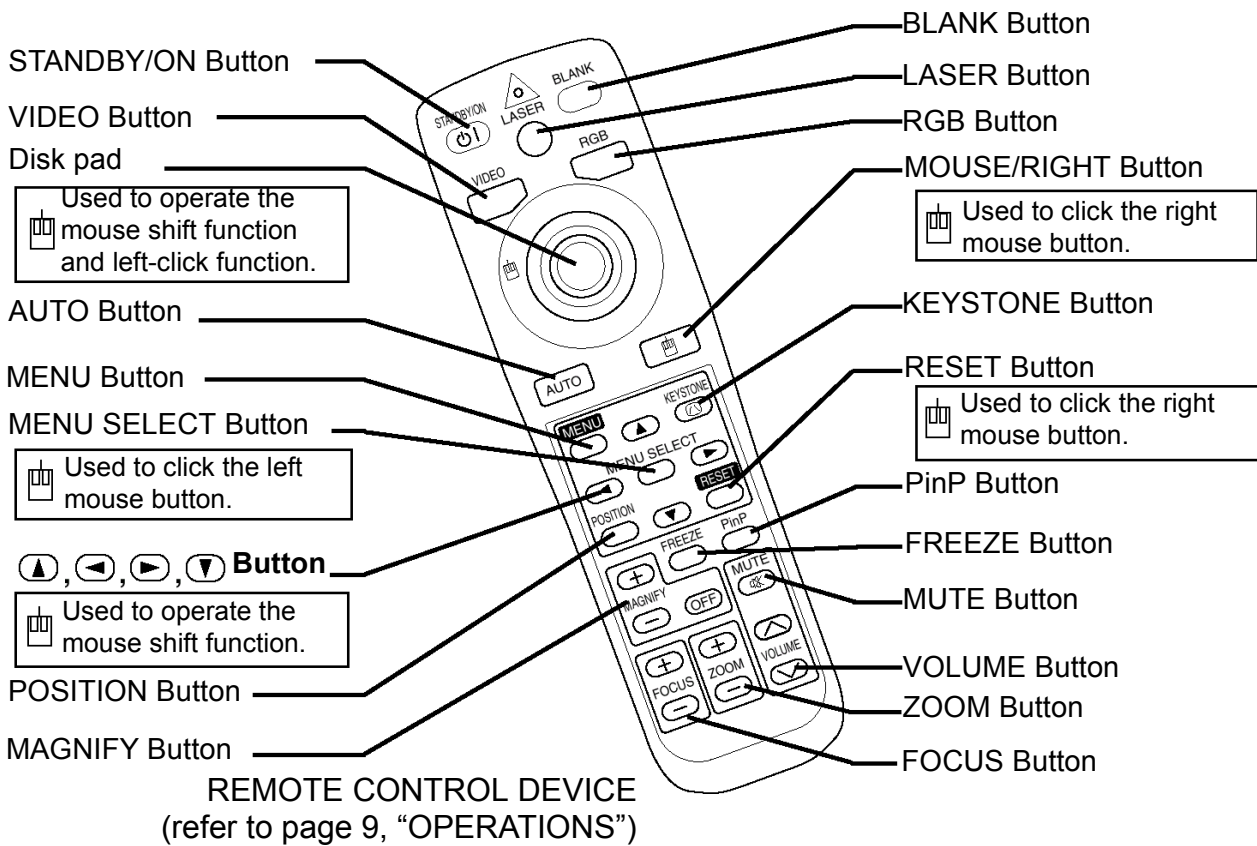

☞ These functions work when the function for controlling the mouse has been activated. The mouse-controlling function will be disabled if POSITION, BLANK ON and MENU ON are selected.

**WARNING** The laser pointer of the remote control device is used instead of a finger or rod. Be sure to never look directly into the laser beam outlet or point the laser beam at other persons. The laser beam may cause serious eye injuries.

**CAUTION** The use of controls, adjustments or performance of procedures other than those specified herein may result in an exposure to hazardous radiation.

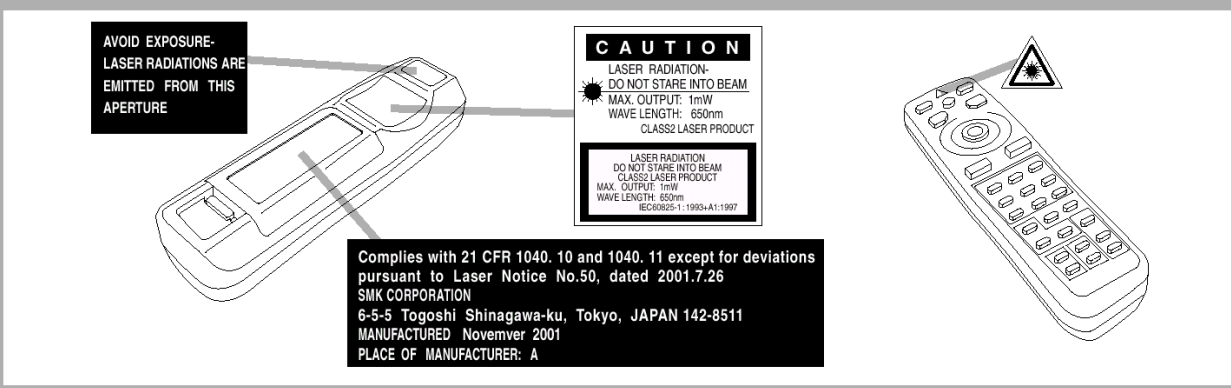

- NOTE:**
- Always keep the remote control device out of reach of children and pets.
  - Be sure to protect the remote control device against any physical impact and do not drop it.
  - Do not place any heavy object on top of the remote control device.
  - Be sure to protect the remote control device against humidity and do not put it on wet objects.
  - Do not leave the remote control device close to the cooling fan outlet of the projector.
  - Do not attempt to disassemble the remote control device.

# Inserting the Batteries

Insert the AA batteries into the remote control device.

- 1 Remove the battery cover.  
Push the knob while lifting up the cover of the battery compartment.
- 2 Insert the batteries.  
Insert the batteries according to their plus and minus poles.
- 3 Replace the cover to the battery compartment.

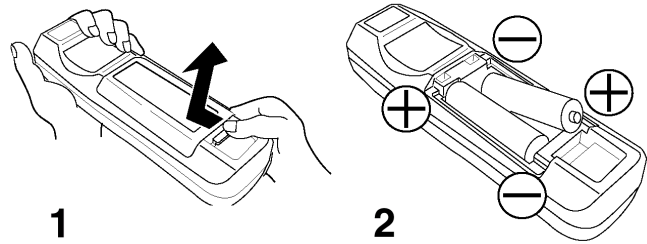

## CAUTION

- Be sure to only use the specified batteries with this remote control device. Do not mix new and old batteries, since this may result in a cracking or leakage of batteries posing a risk of fire or leading to personal injury.
- Insert the batteries into the remote control device according to the indicated plus and minus poles. An incorrect insertion may result in a cracking or leakage of batteries posing a risk of fire or leading to environmental pollution.
- Before disposing of the batteries, please be sure to observe the respective regulations concerning the protection of environment in your area.
- Always be sure to keep the batteries out of reach of children or pets.
- If the remote control device will not be used for an extended period of time, remove the batteries from its battery compartment.

**NOTE:** • Replace the batteries if the operation of the remote control device becomes irregular or weak.

# INSTALLATION

## Installation of the Projector and Screen

To set the screen size and projection distance, see the illustration and table below.

The projection distance shown in the table below indicates the full size (1024 × 768 dots).

**a:**Distance from the projector to the screen ( $\pm 10\%$ ).

**b:**Distance from the lens center to the bottom of the screen ( $\pm 10\%$ ).

**Table 1: Reference for Installation**

Screen size [inches (m)]	a [inches (m)]		b [inches (m)]
	Min.	Max.	
40 (1.0)	55 (1.4)	73 (1.9)	1 (3)
60 (1.5)	85 (2.2)	114 (2.9)	2 (4)
80 (2.0)	114 (2.9)	151 (3.8)	2 (6)
100 (2.5)	144 (3.7)	191 (4.9)	3 (7)
120 (3.0)	176 (4.5)	231 (5.9)	3 (9)
150 (3.8)	220 (5.6)	282 (7.2)	4 (11)
200 (5.0)	291 (7.4)	386 (9.8)	6 (15)

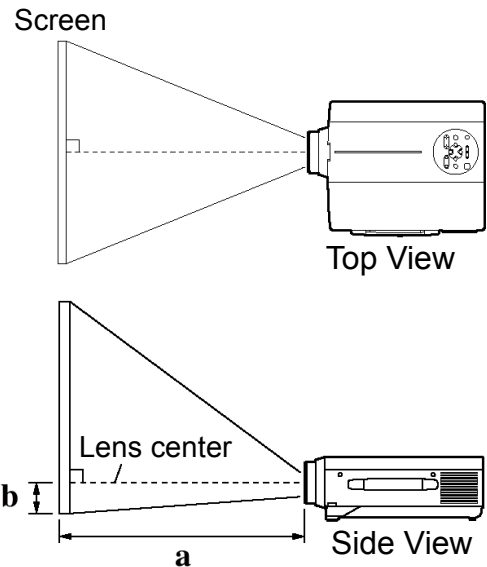

### CAUTION

- Install the projector in a suitable environment as indicated in this manual.
- If you use a metal tool or the like to mount this unit, be sure to connect it via earth connection so as to avoid a risk of fire or electric shock.  
Connect the ground terminal of the AC inlet of this unit to the ground terminal provided in the building using an optional three-core power supply cord.
- Always use the liquid crystal projector in a horizontal position, if possible. If you operate the liquid crystal projector with its lens upwards, its lens downwards or to the side, the heat generated inside the projector may build up and cause malfunctions or damages. Be especially careful to never block the ventilation holes.
- Do not install the LCD projector in a smoky surrounding, since smoke residue may be accumulating on critical parts (i.e. LCD panel, lens, etc.).

## Angle Adjustment

Use the foot adjusters located on the bottom of the projector to adjust the angle of projection. This angle can be adjusted within approximately 0° to 9°.

- 1 Lift up the front side of the projector and press the button of the foot adjuster to adjust the angle of projection.
- 2 To lock the foot adjuster at the desired angle, release the button.
- 3 Turn the screw of the foot adjuster to precisely adjust it. Do not use force, since this could damage the adjuster or result in a failure of the lock.

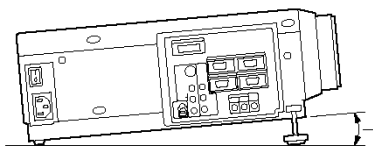
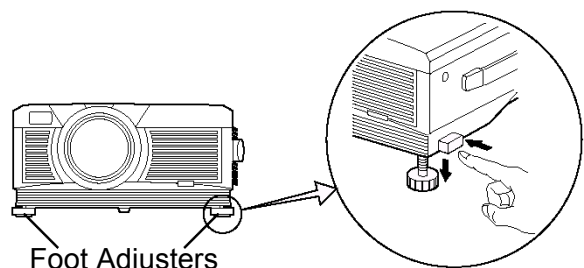

Variable within the range of approximately 0°-9°

### CAUTION

- Do not release the foot adjuster button unless you hold the projector, or else the projector may overturn or the fingers may get caught.



# Cabling

Refer to the table below for connecting each terminal of the projector to each device.

**Table 2: Cabling**

Function	Terminal	Cable
Analog RGB input	<b>RGB IN 1</b>	Accessory or optional RGB cable with D-sub 15-pin shrink jack and inch thread screws.
	<b>RGB IN 2</b>	
Analog RGB output	<b>RGB OUT</b>	
Digital RGB input	<b>DVI</b>	Optional DVI cable with inch thread screws
Audio input (from the computer)	<b>AUDIO IN [RGB 1] / [DVI]</b> (interlocked with RGB IN 1 or DVI)	Optional audio cable with stereo mini-jack
	<b>AUDIO IN [RGB 2] / [DVI]</b> (interlocked with RGB IN 2)	
PS/2 mouse control	<b>CONTROL</b>	Accessory PS/2 mouse cable
ADB mouse control		Optional ADB mouse cable
Serial mouse control		Optional serial mouse cable
RS/232C communication		Optional RS-232C mouse cable
USB mouse control	<b>USB</b>	Optional USB cable
S-video input	<b>S-VIDEO</b>	Optional S-video cable with mini DIN 4-pin jack
Video input	<b>VIDEO</b>	Accessory video/audio cable
Component video input	<b>COMPONENT VIDEO Y</b>	Accessory component video cable
	<b>COMPONENT VIDEO C<sub>B</sub>/P<sub>B</sub></b>	
	<b>COMPONENT VIDEO C<sub>R</sub>/P<sub>R</sub></b>	
Audio input (from video equipment)	<b>AUDIO (MONO)/L</b>	Accessory video/audio cable or optional audio cable with RCA jack
	<b>AUDIO R</b>	
Audio output	<b>AUDIO OUT</b>	Optional audio cable with stereo mini-jack

## CAUTION

- An incorrect connection may result in fire or electric shock. Be sure to read this manual before connect the projector.
- Be sure to turn off all devices to be connected before you connect the projector.
- The cables may have to be connected with their core set to the projector's side. Only connect the cable supplied with the projector or those specified.

**NOTE:** • Before you connect the projector, be sure to read the manual of the respective device to be connected. Make sure the projector is compatible with the devices.

- Secure the screws of the connectors and tighten them.
- The optional Mac adapter may be necessary for certain RGB input modes.
- To select the DVI input, the computer may need to be set. For details on how to set the computer accordingly, refer to the manual of the computer.
- Certain computers may be provided with multiple display modes. The use of such modes may not be possible with this projector.
- For the pin assignment of the connectors and the RS-232C communication data, refer to the service manual of PJ1065-2.
- If you use the DVI terminal, the RGB OUT terminal may not work.

# Power Connection

Be sure to use the correct supplied power cords depending on the power outlet to be connected to. Connect the AC inlet of the projector firmly to the power outlet with the power cord.

## CAUTION

- Be careful when you handle the power cord.
- Firmly connect the power cord. Do not use a loosened or unsafe power outlet or a malfunctioning contact.

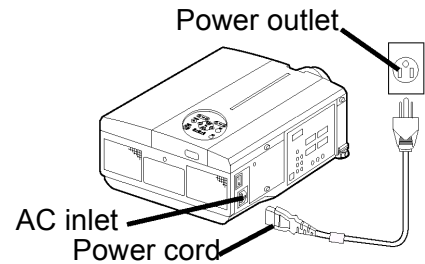

# Example of system setup

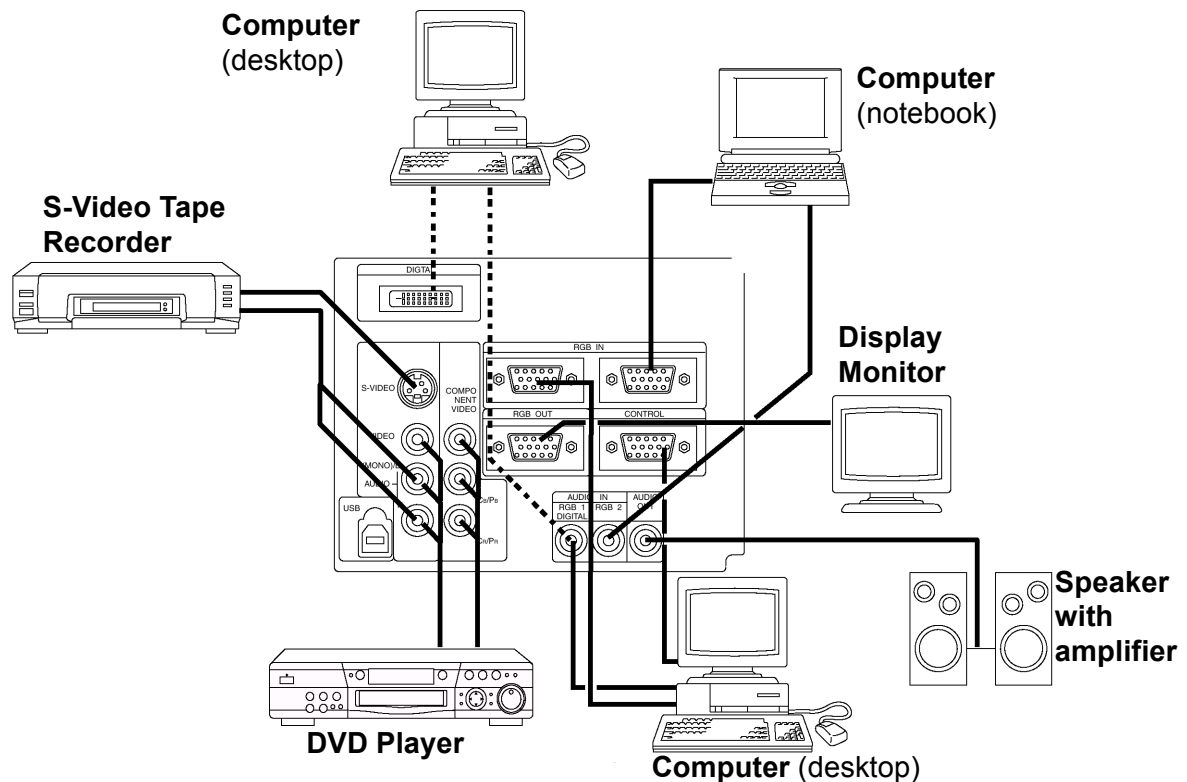

**NOTE:** • When connecting the projector to a notebook computer, set it so as to activate the RGB external image output (setting it to CRT display or to simultaneous LCD and CRT display). For more information, refer to the instruction manual of the notebook computer.

# Plug & Play

This projector is compatible with VESA DDC 1/2B. Plug & Play is possible by connecting to a computer that is compatible with VESA DDC (Display Data Channel).

Use this function by connecting the accessory RGB cable with RGB IN 1 terminal (DDC 1/2B compatible), or by connecting an optional DVI cable with DVI terminal (DDC 2B compatible). Plug & Play does not operate by any other connection.

## NOTE:

- Plug & Play is a system configured with peripheral equipment including a computer and display, and an operating system.
- This projector is recognized as a Plug & Play monitor. Use the standard display drivers.
- Plug & Play may not function properly with the computer to be connected. Use the RGB IN 2 terminal if Plug & Play does not function correctly.

# OPERATIONS

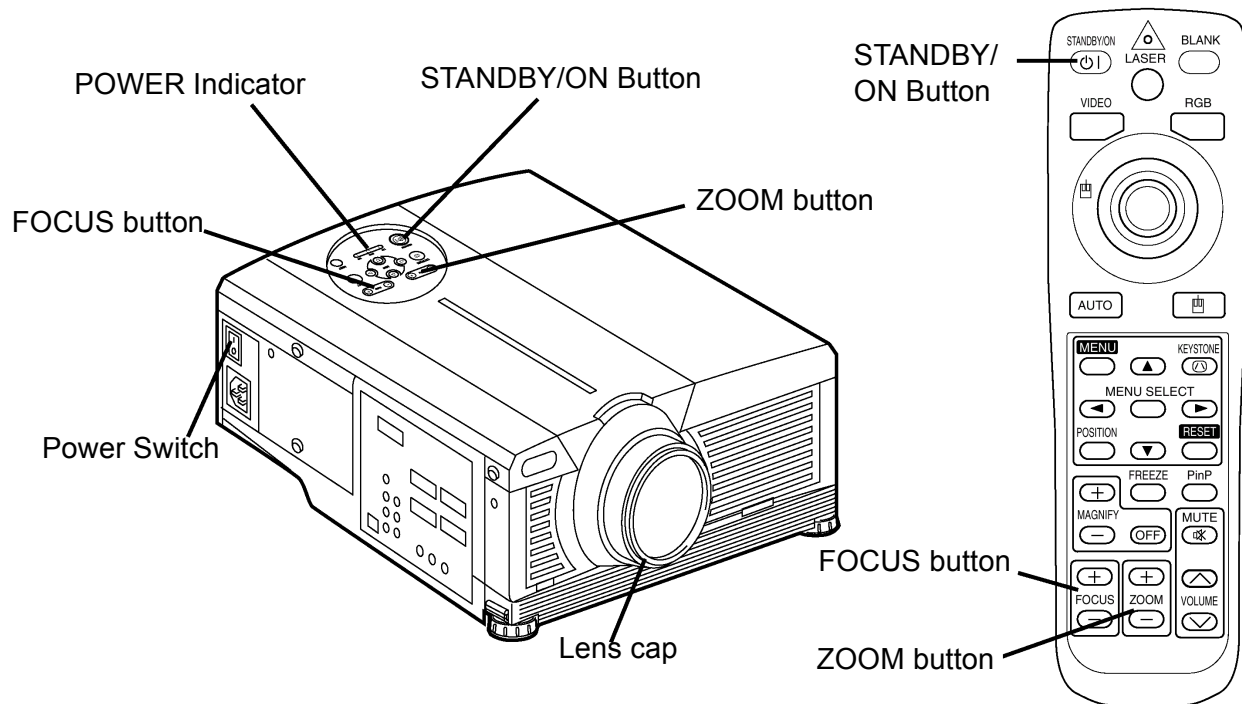

## Power ON

- 1 Check if the power cord is connected correctly.
- 2 Set the power switch to [I]. When the standby mode is selected, the POWER indicator is orange.
- 3 Press the STANDBY/ON button on the control panel or the remote control device. The warm-up starts and the POWER indicator blinks green.
- 4 The POWER indicator stops blinking and turns green when the power is on. Remove the lens cap.
- 5 Adjust picture size with the ZOOM button.
- 6 Adjust focus with the FOCUS button.

## Power OFF

- 1 Press the STANDBY/ON button on the control panel or the remote control device. Then the message "Power off?" will appear on the screen, and the message will disappear by any operation or if no operation is carried out for 5 seconds. During this message indication, press the STANDBY/ON button again. The projector lamp is turned off and the lamp will be cooled down. The POWER indicator blinks orange when the lamp cools down. Pressing the STANDBY/ON button has no effect while the POWER indicator is blinking.
- 2 The system goes into the Standby mode after cooling and the POWER indicator stops blinking and changes to orange. Check if the indicator is orange and set the power switch to [0].
- 3 The POWER indicator goes out when the power is switched off. Attach the lens cap.

**WARNING:** Before using this equipment, read this manual thoroughly. Always ensure that the equipment is used safely.

**NOTE:** • Except in emergencies, follow the above-mentioned procedure for turning the power off. Any incorrect procedure will shorten the life of the projector lamp and LCD panel.

- To prevent any trouble, turn on/off the projector when the computer or video tape recorder is OFF. Providing a RS-232C cable is connected, turn on the computer before switching on the projector.
- If the projector continues projecting the same image, the image may remain as an after-image. Do not project the same image for a long time.

# Basic Operation

The basic operations shown in Table 3 can be performed with the supplied remote control device or by way of the projector's control panel. Items indicated by (\*) may be used from the control panel.





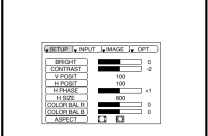
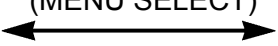











**Table 3: Basic Operation**

Item	Description
INPUT SELECT	<p><b>Select Input Signal (*)</b>: Press the INPUT button.  <b>RGB IN 1→RGB IN 2→DVI</b>  <b>→VIDEO→S-VIDEO→COMPONENT VIDEO (→RGB IN 1)</b></p> <p><b>Select RGB Input</b>: Press the RGB button.            VIDEO/S-VIDEO/COMPONENT VIDEO→RGB IN 1/RGB IN 2/DVI            RGB IN 1→RGB IN 2→DVI (→RGB IN 1)</p> <p><b>Select Video Input</b>: Press the VIDEO button.            RGB IN 1/RGB IN 2/DVI→VIDEO/S-VIDEO/COMPONENT VIDEO            VIDEO→S-VIDEO→COMPONENT VIDEO (→VIDEO)</p> <ul style="list-style-type: none"> <li>• The selected signal name is displayed for approximately 3 seconds when the input signal is changed.</li> </ul>
POSITION	<p><b>Set/Clear Position Adjustment Mode</b>: Press the POSITION button. The [ ] icon is displayed in the POSITION mode.</p> <p><b>Image Position Adjustment</b>: Press the ◀, ▶, ▲ and ▼ buttons in the POSITION mode.</p> <ul style="list-style-type: none"> <li>• Valid only in the MAGNIFY mode if a video signal is input.</li> <li>• After approximately 10 seconds of inactivity the [ ] icon is extinguished and the POSITION mode will be cleared automatically.</li> <li>• ◀, ▶, ▲ and ▼ buttons may operate as the mouse control button. See page 4.</li> </ul>
RESET (*)	<p><b>Initialize Each Item</b>: Select an item and press the RESET button.</p> <p><b>Initialize Position Adjustment</b>: Press the RESET button and the POSITION mode. This function is valid only if a RGB signal is the input.</p> <ul style="list-style-type: none"> <li>• Valid except for the VOLUME, LANGUAGE, WHISPER and H PHASE.</li> <li>• The RESET button may operate as the mouse control button. Refer to page 4.</li> </ul>
MAGNIFY	<p><b>Set MAGNIFY Mode</b>: Press the MAGNIFY ⊕ button.</p> <p><b>Move Magnified Area</b>: Run the POSITION in the MAGNIFY mode.</p> <p><b>Adjust Magnification</b>: Press the MAGNIFY ⊕ / ⊖ button in MAGNIFY mode.</p> <p><b>Clear MAGNIFY Mode</b>: Press the MAGNIFY OFF button.</p> <ul style="list-style-type: none"> <li>• The MAGNIFY mode is cleared by running or setting the AUTO, ASPECT, INPUT SELECT or VIDEO, or by changing the input signal.</li> </ul>
FREEZE	<p><b>Set/Clear FREEZE Mode</b>: Press the FREEZE button. The [ ] icon is displayed, and the image will be frozen in the FREEZE mode.</p> <ul style="list-style-type: none"> <li>• The FREEZE mode is cleared by running or setting POSITION, VOLUME, MUTE, Automatic Adjustment, BLANK ON/OFF, or MENU ON/OFF, or by changing the input signal.</li> <li>• Do not forget to clear frozen static images.</li> </ul>

**NOTE:** • Use the remote control device at a distance of approximately 5 m from the sensor on the front of the projector, and within a range of 30 °left-right. Strong light and obstacles will interfere with the operation of the remote control device.

Items indicated by (\*) may be used with the control panel.

**Table 3: Basic Operation (continued)**

Item	Description
VOLUME	<b>Volume Adjustment:</b> Press the VOLUME  /  button.
MUTE	<b>Set/Clear Mute Mode:</b> Press the MUTE button. No sound is heard in the MUTE mode.
AUTO	<p><b>Automatic Adjustment at RGB Input:</b> Press the AUTO button. Horizontal position(H. POSIT), vertical position (V. POSIT), clock phase (H. PHASE), and horizontal size(H. SIZE) are automatically adjusted. Use with the window at maximum size in the application display.</p> <p><b>Automatic Adjustment at Video Input:</b> Press the AUTO button. A signal type appropriate for the input signal is selected automatically. Valid only when AUTO is set for VIDEO on the menu.</p> <ul style="list-style-type: none"> <li>• This operation requires approximately 10 seconds. It may not function correctly with some input signals.</li> </ul>
BLANK ON/ OFF	<b>Set/Clear Blank Mode:</b> Press the BLANK button. No image is displayed in the Blank mode.
MENU ON/ OFF (*)	<p><b>Menu Display Start/Stop:</b> Press the MENU button.</p> <ul style="list-style-type: none"> <li>• The menu display is terminated automatically after approximately 10 seconds of inactivity.</li> </ul>
MENU SELECT	<p><b>Select Menu Type:</b> Press the MENU SELECT button. Allows the user to select the normal menu or the single menu. Only the selected item is displayed on the single menu, and other items are displayed with the  and  buttons as with the normal menu.</p> <ul style="list-style-type: none"> <li>• Valid only when the Setup menu is used. Push the MENU SELECT button after selecting items such as "BRIGHTNESS".</li> <li>• The MENU SELECT button may operate as the mouse control button. Refer to page 4.</li> </ul> <div style="display: flex; justify-content: space-around; align-items: center;"> <div style="text-align: center;"> <p><b>Normal menu</b></p>  </div> <div style="text-align: center;"> <p>(MENU SELECT)</p>  </div> <div style="text-align: center;"> <p><b>Single menu</b></p>  </div> </div>
P.IN P. MODE	<p><b>Select Mode of P.IN P. Display:</b> Press the PinP button.</p> <p>Small→Large→P.IN P. off (→Small)</p> <ul style="list-style-type: none"> <li>• Valid only at RGB IN 1, RGB IN 2 or DVI input.</li> </ul>
ZOOM (*)	<b>Adjust Screen Size:</b> Press the ZOOM  /  button.
FOCUS (*)	<b>Adjust Focus:</b> Press the FOCUS  /  button.
KEYSTONE (*)	<p><b>Set / Clear KEYSTONE Mode:</b> Press the KEYSTONE  button.</p> <p><b>Select KEYSTONE Mode:</b> Press the  /  button in the KEYSTONE mode.</p> <p>Vertical  ↔  Horizontal</p> <p><b>Adjust KEYSTONE:</b> Press the  /  button.</p>

# Setup Menu

The following adjustments and settings are possible when SETUP is selected at the top of the menu. Part of the Setup menu differs between RGB input and video input. Select an item with the  $\blacktriangle$  and  $\blacktriangledown$  buttons, and start operation. Use the Single menu to reduce menu size (see Table 3, MENU SELECT).

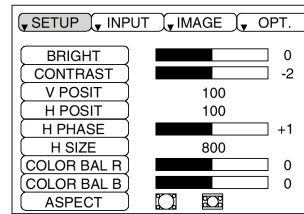

RGB IN 1  
RGB IN 2  
DVI

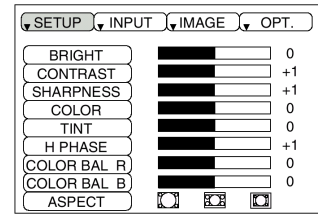





VIDEO  
S-VIDEO  
COMPONENT VIDEO

Table 4: Setup Menu







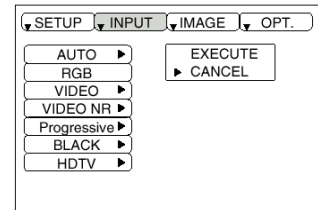





Item	Description	RGB IN 1 RGB IN 2	DVI	VIDEO S-VIDEO COMPONENT
BRIGHT	<b>Adjustment:</b> Dark $\blacktriangleleft$ $\leftrightarrow$ Light $\blacktriangleright$	√	√	√
CONTRAST	<b>Adjustment:</b> Weak $\blacktriangleleft$ $\leftrightarrow$ Strong $\blacktriangleright$	√	√	√
V POSIT	<b>Adjustment:</b> Down $\blacktriangleleft$ $\leftrightarrow$ Up $\blacktriangleright$	√	–	–
H POSIT	<b>Adjustment:</b> Left $\blacktriangleleft$ $\leftrightarrow$ Right $\blacktriangleright$	√	–	–
H PHASE	<b>Adjustment:</b> Left $\blacktriangleleft$ $\leftrightarrow$ Right $\blacktriangleright$ • Adjust to eliminate flicker.	√	–	√
H SIZE	<b>Adjustment:</b> Small $\blacktriangleleft$ $\leftrightarrow$ Large $\blacktriangleright$ • The image may not be displayed correctly if the horizontal size is excessive. In such cases, press the RESET button, and initialize the horizontal size.	√	–	–
SHARPNESS	<b>Adjustment:</b> Soft $\blacktriangleleft$ $\leftrightarrow$ Clear $\blacktriangleright$	–	–	√
COLOR	<b>Adjustment:</b> Light $\blacktriangleleft$ $\leftrightarrow$ Dark $\blacktriangleright$	–	–	√
TINT	<b>Adjustment:</b> Red $\blacktriangleleft$ $\leftrightarrow$ Green $\blacktriangleright$ • Valid only when NTSC or NTSC 4.43 signal is received.	–	–	√
COLOR BAL R	<b>Adjustment:</b> Light $\blacktriangleleft$ $\leftrightarrow$ Dark $\blacktriangleright$	√	√	√
COLOR BAL B	<b>Adjustment:</b> Light $\blacktriangleleft$ $\leftrightarrow$ Dark $\blacktriangleright$	√	√	√
ASPECT	<b>Select Image Aspect Ratio:</b> 4:3 [  ] $\blacktriangleleft$ $\leftrightarrow$ $\blacktriangleright$ 16:9 [  ] <b>Select position of image:</b> Press the $\blacktriangledown$ button when 16:9 [  ] has been selected. Center $\rightarrow$ $\blacktriangledown$ Down $\rightarrow$ $\blacktriangledown$ Up ( $\rightarrow$ Center $\blacktriangledown$ )	√	√	–
	<b>Select Image Aspect Ratio:</b> 4:3 [  ] $\blacktriangleleft$ $\leftrightarrow$ $\blacktriangleright$ 16:9 [  ] $\blacktriangleleft$ $\leftrightarrow$ $\blacktriangleright$ 4:3 small [  ] <b>Select position of image:</b> Press the $\blacktriangledown$ button when 16:9 [  ] / 4:3 small [  ] has been selected. Center $\rightarrow$ $\blacktriangledown$ Down $\rightarrow$ $\blacktriangledown$ Up ( $\rightarrow$ Center $\blacktriangledown$ ) • 4:3 small cannot be selected with the input of 720P or 1080i component. • 4:3 small may not be displayed correctly with some input signals.	–	–	√

# Input Menu

The following functions are available when INPUT is selected on the menu. Select an item with the  and  buttons, and start or stop operation with the  and  buttons. The function indicated (\*\*) are effective on video input mode, the P.IN P. window on RGB input mode.

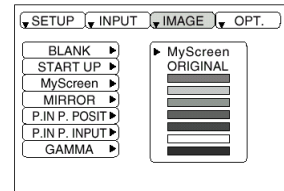

**Table 5: Input Menu**

Item	Description
AUTO	<p><b>Automatic Adjustment at RGB Input:</b> Select the EXECUTE with the  button. Horizontal position (H.POSIT), vertical position (V.POSIT), clock phase (H.PHASE), and horizontal size (H.SIZE) are automatically adjusted. Use with the window at maximum size in the application display.</p> <p><b>Automatic Adjustment at Video Input:</b> Select the EXECUTE with the  button. A signal type appropriate for the input signal will be selected automatically. Valid only when AUTO is set for VIDEO on the menu.</p> <ul style="list-style-type: none"> <li>• This operation requires approximately 10 seconds. It may not function correctly with some input signals. Pressing the AUTO button in this case may correct this problem.</li> <li>• This function is the same as for the AUTO function in Basic operation.</li> </ul>
RGB	<p><b>Displays RGB Input Frequency:</b> Displays the horizontal and vertical sync signal frequencies for RGB input.</p> <ul style="list-style-type: none"> <li>• Valid only at RGB input.</li> </ul>
VIDEO (**)	<p><b>Select Video Signal Type:</b> Select the signal type with the  and  buttons. Select NTSC, PAL, SECAM, NTSC4.43, M-PAL, or N-PAL as appropriate for the input signal. The selection of AUTO enables and executes the function AUTO (Automatic Adjustment at Video Input), except for the N-PAL input.</p> <ul style="list-style-type: none"> <li>• Use this function when the image becomes unstable (eg. the image becomes irregular, or lacks color) at VIDEO/S-VIDEO input.</li> <li>• Automatic Adjustment requires approximately 10 seconds. It may not function correctly with some input signals. Pressing the AUTO button in this case may correct this problem except for the N-PAL input.</li> <li>• For the COMPONENT VIDEO input, this function is not effective and the signal type is distinguished automatically.</li> </ul>
VIDEO NR (**)	<p><b>Set/Clear Noise Reduction Mode:</b> Select the TURN ON / TURN OFF with the  /  button. When the TURN ON is selected, the NR mode is active and the noise on screen of the video input will be reduced.</p> <ul style="list-style-type: none"> <li>• Valid except for the HDTV.</li> </ul>
Progressive (**)	<p><b>Select Progressive Mode:</b> Select the mode suitable for the input signal with the  /  buttons. The TV mode and the FILM mode convert the interlaced video signal into the progressive signal. The FILM mode is adaptable 2-3 Pull-Down system to the conversion.</p> <ul style="list-style-type: none"> <li>• Use this function to raise resolution, at the interlaced video input except HDTV signal.</li> </ul>
BLACK (**)	<p><b>Set/Clear Black Enhancement Mode:</b> Select the TURN ON / TURN OFF with the  /  button. When the TURN ON is selected, the black enhancement mode is active and the contrast ratio of the screen for the video input will be raised by making black level darker.</p>
HDTV (**)	<p><b>Select HDTV mode:</b> Select the 1035i mode or 1080i mode suitable for the input signal with the  /  button.</p>

# Image Menu

The following adjustments and settings are available when IMAGE is selected on the menu. Select an item with the ▲ and ▼ buttons, and start or stop operation with the ► and ◀ buttons.



**Table 6: Image Menu**

Item	Description
BLANK	<p><b>Select Blank Screen:</b> Select the screen with the ▲ / ▼ button. The selected one (MyScreen, ORIGINAL or one colors) is displayed when the BLANK mode is ON. <b>MyScreen</b> is a mode that the customer-customized screen is displayed. This is the blue screen at the factory setting. Refer to the description of MyScreen below. <b>ORIGINAL</b> is a mode that the factory fixed screen is displayed.</p> <ul style="list-style-type: none"> <li>• When MyScreen or ORIGINAL is selected, the screen is going blank after several minutes.</li> </ul>
START UP	<p><b>Select Start Up Screen:</b> Select the screen in case of no signal input with the ▲ / ▼ button. The selected one (MyScreen, ORIGINAL or TURN OFF) is displayed when no signal is input</p> <p><b>MyScreen</b> is a mode that the customer-customized screen is displayed. This is the blue screen at the factory setting. Refer to the description of MyScreen below. <b>ORIGINAL</b> is a mode that the factory fixed screen is displayed. <b>TURN OFF</b> displays the blue screen.</p> <ul style="list-style-type: none"> <li>• When MyScreen or ORIGINAL is selected, the screen is going blank after several minutes.</li> </ul>
MyScreen	<p><b>Set MyScreen Mode:</b> Select the EXECUTE with the ▲ button to display the MyScreen menu and set the MyScreen mode for BLANK and START UP functions.</p> <p><b>ESC</b> clears and closes the menu box.</p> <p><b>NORM.</b> is default of the MyScreen menu.</p> <p><b>FREEZE</b> freezes the image and displays the frame to capture. Press the button after freeze to go to the MyScreen Capture Position mode. <u>In the MyScreen Capture Position mode</u>, the buttons ▼, ▲, ◀ and ► allow to move the frame to capture. After adjusting the position, press the KEYSTONE button to go to the MyScreen Display Size mode. To cancel freezing and return to the NORM. Mode of the MyScreen menu, press the RESET button. <u>In the MyScreen Display Size mode</u>, select the magnification x1, x2 or FULL with the button ◀ / ► . After selecting the magnification, press the KEYSTONE button to go to the CAPT. mode and start capturing. To return to the MyScreen Capture Position mode, press the RESET button. <b>CAPT.</b> executes a capturing the image. It requires about 20 seconds. After capturing, the captured image will be displayed for about 10 seconds.</p>
MIRROR	<p><b>Select Mirror Status:</b> Select mirror status with ▲ / ▼ button.</p>
P. IN P. POSIT	<p><b>Select Position of P. in P. Display:</b> Press the ▲ / ▼ button.</p> <p>■ ▲ ↔ ▼ ■ ▲ ↔ ▼ ■ ▲ ↔ ▼ ■</p> <ul style="list-style-type: none"> <li>• Valid only at RGB IN 1, RGB IN 2 or DVI input.</li> </ul>
P. IN P. INPUT	<p><b>Select signal of P. in P. Display:</b> Press the ▲ / ▼ button.</p> <p>VIDEO ▲ ↔ ▼ S-VIDEO ▲ ↔ ▼ COMPONENT</p>
GAMMA	<p><b>Select Gamma Mode:</b> Select the gamma mode with the ▲ / ▼ button.</p> <p>NORMAL ▲ ↔ ▼ CINEMA ▲ ↔ ▼ DYNAMIC</p>



# Options Menu

The following adjustments and settings are available when OPT. is selected on the menu. Select an item with the ▲ and ▼ buttons, and start operation.

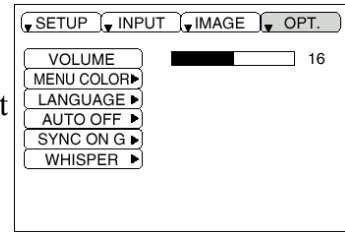
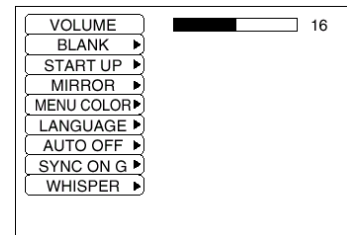

**Table 7: Options Menu**

Item	Description
VOLUME	<b>Volume Adjustment:</b> Reduce VOLUME ◀ ↔ Increase VOLUME ▶
MENU COLOR	<b>Select Menu Background Color:</b> Select with the ▶ and ◀ buttons.
LANGUAGE	<b>Operation Start/Stop:</b> Press the ▶ / ◀ button. <b>Select Menu Display Language:</b> Select with the ▲ and ▼ buttons.
AUTO OFF	<b>Operation Start/Stop:</b> Press the ▶ / ◀ button. <b>Set AUTO OFF:</b> Set 1-99 minutes with the ▲ and ▼ buttons. The system automatically enters the standby mode when a signal is not received for the set time. <b>Clear AUTO OFF:</b> Select STOP (0 min.) with the ▼ button. When STOP is selected the system does not enter the standby mode even if no signal is received.
SYNC ON G	<b>Operation Start/Stop:</b> Press the ▶ / ◀ button. <b>SYNC ON G Valid:</b> Select TURN ON with the ▲ button. <b>SYNC ON G Invalid:</b> Select TURN OFF with the ▼ button. • May not be displayed correctly with some input signals when SYNC ON G is valid. In such cases, remove the signal connector so that no signal is received, set SYNC ON G to invalid, and reconnect the signal.
WHISPER	<b>Set / Clear WHISPER Mode:</b> Press the ▶ / ◀ button. When WHISPER is selected, the WHISPER mode is active. In the WHISPER mode, acoustic noise level from the unit is reduced, and brightness level on screen is a little lower.

# No Signal Menu

The same adjustments and settings are available as with the Image and Options menus when the MENU button is pressed during display of the “NO INPUT IS DETECTED ON\*\*\*” or “SYNC IS OUT OF RANGE ON\*\*\*” message while no signal is received.



**Table 8: No Signal Menu**

Item	Description
VOLUME	<p><b>Volume Adjustment:</b> Reduce VOLUME ◀ ↔ Increase VOLUME ▶</p> <ul style="list-style-type: none"> <li>When this function is used, audio input is automatically switched to video. The audio input can be switched by moving the DISK PAD left and right during the display of the volume adjustment bar. The volume adjustment bar is displayed by pressing VOLUME ◊ or VOLUME ◂ button.</li> </ul>
BLANK	<p><b>Select Blank Screen:</b> Select the screen with the ▲ / ▼ button. The selected one (MyScreen, ORIGINAL or one colors) is displayed when the BLANK mode is ON. <b>MyScreen</b> is a mode that the customer-customized screen is displayed. This is the blue screen at the factory setting. Refer to the description of MyScreen below. <b>ORIGINAL</b> is a mode that the factory fixed screen is displayed.</p> <ul style="list-style-type: none"> <li>When MyScreen or ORIGINAL is selected, the screen is going blank after several minutes.</li> </ul>
START UP	<p><b>Select Start Up Screen:</b> Select the screen in case of no signal input with the ▲ / ▼ button. The selected one (MyScreen, ORIGINAL or TURN OFF) is displayed when no signal is input</p> <p><b>MyScreen</b> is a mode that the customer-customized screen is displayed. This is the blue screen at the factory setting. Refer to the description of MyScreen below. <b>ORIGINAL</b> is a mode that the factory fixed screen is displayed. <b>TURN OFF</b> displays the blue screen.</p> <ul style="list-style-type: none"> <li>When MyScreen or ORIGINAL is selected, the screen is going blank after several minutes.</li> </ul>
MIRROR	<p><b>Operation Start/Stop:</b> Press the ▶ / ◀ button.</p> <p><b>Select Mirror Status:</b> Select the mirror status with the ▲ and ▼ buttons.</p>
MENU COLOR	<p><b>Select Menu Background Color:</b> Select the color with the ▶ and ◀ buttons.</p>
LANGUAGE	<p><b>Operation Start/Stop:</b> Press the ▶ / ◀ button.</p> <p><b>Select Menu Display Language:</b> Select the language with the ▲ and ▼ buttons.</p>
AUTO OFF	<p><b>Operation start/stop:</b> Press the ▶ / ◀ button.</p> <p><b>Set AUTO OFF:</b> Set 1-99 minutes with the ▲ and ▼ buttons. The system automatically enters the standby mode when a signal is not received for the set time.</p> <p><b>Clear AUTO OFF:</b> Select the STOP (0 min.) with the ▼ button. When STOP is selected the system does not enter the standby mode even if no signal is received.</p>
SYNC ON G	<p><b>Operation Start/Stop:</b> Press the ▶ / ◀ button.</p> <p><b>SYNC ON G Valid:</b> Select the TURN ON with the ▲ button.</p> <p><b>SYNC ON G Invalid:</b> Select the TURN OFF with the ▼ button.</p> <ul style="list-style-type: none"> <li>May not be displayed correctly with some input signals when the SYNC ON G is valid. In such cases, remove the signal connector so that no signal is received, set the SYNC ON G to invalid, and reconnect the signal.</li> </ul>
WHISPER	<p><b>Set / Clear WHISPER Mode:</b> Press the ▶ / ◀ button. When WHISPER is selected, the WHISPER mode is active. In the WHISPER mode, acoustic noise level from the unit is reduced, and brightness level on screen is a little lower.</p>

# MAINTENANCE

## Lamp



HIGH VOLTAGE  
HIGH TEMPERATURE  
HIGH PRESSURE

Contact your dealer before replacing the lamp.

For the lamp replacement, see the item “Optional Parts” of the Table 12.

Before replacing the lamp, switch power OFF, remove the power cord from the power outlet, and wait approximately 45 minutes until the lamp has cooled. The lamp may explode if handled at high temperatures.

### WARNING:

- For disposal of used lamp, treat according to the instruction of community authorities.
- Since the lamp is made of glass, do not apply shock to it and do not scratch it.
- Also, do not use old lamp. This could also cause explosion of the lamp.
- Premature lamp failure MAY be caused by an electronic component in the projector and not necessarily the lamp. If unsure contact your local service center.
- If it is probable that the lamp has exploded (explosive sound is heard), disconnect the power plug from the power outlet and ask your dealer to replace lamp. The lamp is covered by front glass, but, in rare cases, the reflector and the inside of the projector may be damaged by scattered broken pieces of glass, and broken pieces could cause injury when being handled.
- Do not use the projector with the lamp cover removed.

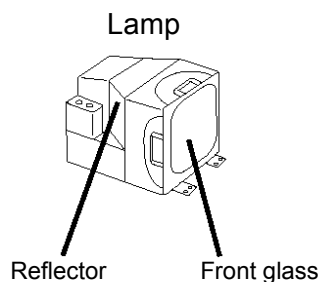

## Lamp Life

Projector lamps have a finite life. The image will become darker, and hues will become weaker, after a lamp has been used for a long period of time. Replace the lamp if the LAMP indicator is red, or the CHANGE THE LAMP message appears when the projector is switched ON. See Table 9 on p. 20 and Table 10 on p. 21.

**NOTE:** • The LAMP indicator is also red when the lamp unit reaches high temperature. Before replacing the lamp, switch power OFF, wait approximately 20 minutes, and switch power ON again. If the LAMP indicator is still red, replace the lamp.

## Replacing the Lamp

- 1 Switch the projector OFF, remove the power cord from the power outlet, and wait at least 45 minutes for the unit to cool.
- 2 Prepare a new lamp.
- 3 Check that the projector has cooled sufficiently, and gently turn it upside down.
- 4 Loosen the screw as shown in the diagram, and remove the lamp cover.
- 5 Loosen the two screws, and gently remove the lamp while holding the grips. Touching the inside of the lamp case may result in uneven coloring.
- 6 Install the new lamp and tighten the two screws firmly. Also steadily push the opposite side of the screwed lamp into the unit.
- 7 Replace the lamp cover in position and tighten the screw firmly.
- 8 Gently turn the projector right-side up.

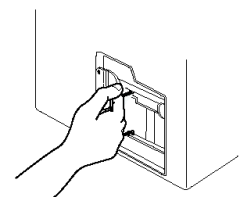
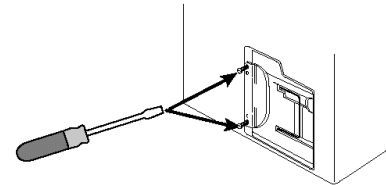
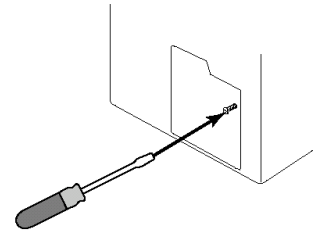

### CAUTION

- Ensure that screws are tightened properly. Screws not tightened fully may result in injury or accidents.
- Do not use the projector with the lamp cover removed.

## Resetting the Lamp Timer

Reset the lamp timer after replacing the lamp. When the lamp has been replaced after the LAMP indicator is red, or the CHANGE THE LAMP message is displayed, complete the following operation within ten minutes of switching power ON. The power will be turned off automatically if over 10 minutes.

- 1 Switch power ON, and press the RESET button, for approximately three seconds. The 'LAMP xxxx hr' message will appear on the lamp timer on the bottom of the screen.
- 2 Press the MENU button on the remote control transmitter, or the RESET button on the control panel, while the lamp timer is displayed. The 'LAMP xxxx  → 0  CANCEL' message will then appear.
- 3 Press the  and select 0, and wait until the timer display is cleared.

**NOTE:** • Do not reset the lamp timer without replacing the lamp. Reset the lamp timer always when replacing the lamp. The message functions will not operate properly if the lamp timer is not reset correctly.

## Air Filters

### Cleaning Air Filters

This projector uses 2 air filters. These air filters should be cleaned as described below at intervals of approximately 100 hours.

- 1 Switch the projector power supply OFF, and remove the power cord from the power outlet.
- 2 Remove the filter cover and the air filter.
- 3 Clean the air filter with a vacuum cleaner.
- 4 Set the air filter and the filter cover.

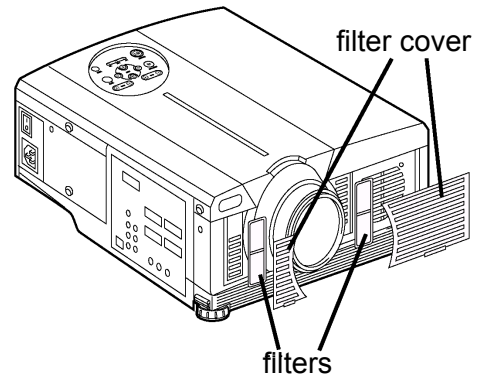

### Replacing the Air Filter

Replace the air filter if contamination cannot be removed, or if it is damaged. Contact your dealer in such case.

- 1 Switch the projector power supply OFF, and remove the power cord from the power outlet.
- 2 Remove the filter cover and the old filter.
- 3 Set the new filter and the filter cover.

#### CAUTION

- Switch power OFF and remove the power cord from the power outlet before beginning maintenance work.
- Replace the air filter if contamination cannot be removed, or if it is damaged.
- Do not use the equipment with the air filter removed.
- When the air filter is clogged with dust etc., the power supply is switched OFF automatically to prevent the temperature rising inside the projector.

## Other Maintenance

### Maintenance Inside the Equipment

For safety reasons, ensure that the equipment is cleaned and checked by the dealer once every two years. Maintaining the equipment by yourself is dangerous.

### Cleaning the Lens

Gently wipe the lens with lens cleaning paper. Do not touch the lens with your hands.

### Cleaning the Cabinet and Remote control transmitter

Gently wipe with a soft cloth. If dirt and stains etc. are not easily removed, use a soft cloth dampened with water, or water and a neutral detergent, and wipe dry with a soft, dry cloth.

#### CAUTION

- Switch power OFF and remove the power cord from the power outlet before beginning maintenance work.
- Do not use detergents or chemicals other than those noted above (e.g. benzene or thinners).
- Do not use cleaning sprays.
- Do not rub with hard materials, or tap the equipment.

# TROUBLESHOOTING

## OSD Message

The messages as described below may appear on the screen at power ON. Take the appropriate measures when such messages appear.

**Table 9: OSD Message**

Message	Contents
CHANGE THE LAMP AFTER REPLACING LAMP, RESET THE LAMP TIME. (*1)	The usage time of lamp will be reaching 2000 hr shortly (*2). It is recommended to replace the lamp soon. Prepare a new lamp as replacement.
CHANGE THE LAMP AFTER REPLACING LAMP, RESET THE LAMP TIME. THE POWER WILL TURN OFF AFTER **hr. (*1)	The usage time of lamp will be reaching 2000 hr shortly. It is recommended to replace the lamp within * * hours (*2). It might happen that the lamp is cut off before * * hr by any chance. Power will be switched OFF automatically in * * hours. Replace the lamp as shown on p. 17-18, "Lamp." Always reset the lamp timer after replacing the lamp.
CHANGE THE LAMP AFTER REPLACING LAMP, RESET THE LAMP TIME. THE POWER WILL TURN OFF AFTER 0 hr.	The usage time of lamp is about to reach. Power will be switched OFF in a few minutes (*2). Switch power OFF immediately and replace the lamp as shown on p. 17-18, "Lamp." Always reset the lamp timer after replacing the lamp.
NO INPUT IS DETECTED ON ***	No input signal found. Check the signal input connections and signal sources.
SYNC IS OUT OF RANGE ON ***	The horizontal or vertical frequency of the input signal is not within the specified range. Check the specifications of the equipment and the signal source.
CHECK THE AIR FLOW	The internal temperature has risen. Switch power OFF, and wait 20 minutes until the equipment cools down. Check the following and Switch power ON again. * Are the ventilation openings blocked. * Is the air filter dirty. * Is the ambient temperature higher than 35°C.

### NOTE:

(\*1) This message is cleared automatically after approximately three minutes, and appears every time power is switched ON.

(\*2) The unit has a function to turn the power off which will be active when the usage time reaches 2000 hr. However the life of lamp might be much different, so that it might happen that a lamp is cut off before the function is active.

# Indicator Message

The POWER indicator, LAMP indicator, and TEMP indicator are lit and blank as follows. Take the appropriate measures.

**Table 10: Indicator Message**



POWER indicator	LAMP indicator	TEMP indicator	Contents
Lit orange	Turns off	Turns off	The Standby mode has been set.
Blinks green	Turns off	Turns off	Warming up. Please wait.
Lit green	Turns off	Turns off	ON. Normal operation possible.
Blinks orange	Turns off	Turns off	Cooling down. Please wait.
Lit red	Lit red	Turns off	Lamp is not lit. The interior of the equipment may be too hot. Switch power OFF, wait 20 minutes until the equipment cools, and check whether the ventilation openings are blocked, whether the air filter is dirty, or whether the ambient temperature exceeds 35 °C. And switch power ON again. Replace the lamp if the same problem occurs.
Lit red	Blinks red	Turns off	Lamp or lamp cover is not found, or hasn't been fitted in correctly. Switch power OFF, and wait for 45 minutes until the equipment cools. Check fitting of the lamp and lamp cover, and switch power ON again. Contact your dealer if the same problem occurs again.
Lit red	Turns off	Blinks red	The cooling fan is not operating. Switch power OFF, and wait for 20 minutes until the equipment cools. Check for foreign matters in the fan, and switch power ON again. Contact your dealer if the same problem occurs again.
Lit red	Turns off	Lit red	The interior of the equipment is too hot. Switch power OFF, and wait for 20 minutes until the equipment cools. Check whether the ventilation openings are blocked, whether the air filter is dirty, or whether the ambient temperature exceeds 35 °C. Then switch power ON again. Contact your dealer if the same problem occurs again.

**NOTE:** • When the internal temperature becomes excessive, power is switched OFF automatically for safety reasons, and the indicator is extinguished. Set the power switch to [O] and wait for 20 minutes until the equipment has cooled sufficiently.

# Symptom

Before requesting repair, please check in the following chart. If the situation cannot be corrected, then contact your dealer.

**Table 11: Symptom**

Symptom	Possible cause	Remedy	Page
The power is not turned on.	The main power switch is not turned on.	Turn on the main power switch.	8, 9
	The power cord is disconnected.	Plug the power cord into an AC power outlet.	
No video or audio.	The input is not correctly set.	Use the projector or remote control transmitter to set.	10
	No signal input.	Connect correctly.	7, 8
Video is present but no audio.	The projector is not correctly connected.	Connect correctly.	7, 8
	The volume is set to minimum.	Press VOLUME  on the remote control or display the menu screen and adjust the volume.	11, 15
	Mute is turned on.	Press the MUTE  button.	11
Audio is present but no video.	The projector is not correctly connected.	Connect correctly.	7, 8
	The brightness adjustment knob is rotated fully clockwise.	Select BRIGHT with the MENU button and the press the  button.	12
	The lens cap is still attached.	Remove the lens cap.	9
Colors are pale and color matching is poor.	Color density and color matching are not correctly adjusted.	Adjust the video.	12
Images are dark.	Brightness and contrast are not correctly adjusted.	Adjust the video.	12
	The lamp is approaching the end of its service life.	Replace with a new lamp.	17
Video is blurred.	Focus or H PHASE is out of adjustment.	Adjust the focus or H PHASE.	9, 12



# SPECIFICATIONS

**Table 12: Specifications**

Item		Specification	
Liquid crystal projector	Panel size	3.3 cm (1.3 type)	
	Drive system	TFT active matrix, 1024 × 768 native	
	Pixels	786,432 pixels (1024 horizontal × 768 vertical)	
Lens		Zoom lens F = 1.7 – 2.3; f = 49.0 – 64.0 mm	
Lamp		275 W UHB	
Speaker		1.2 W + 1.2 W (stereo)	
Power supply		AC 100 – 120 V, 4.7 A / AC 220 – 240 V, 2.0 A	
Power consumption		440 W	
Temperature range		0 – 35°C (operating)	
Size		289 (W) × 139 (H) × 345 (D) mm	
Weight (mass)		6.5 kg	
RGB signal input	RGB IN	1	Video: Analog 0.7 Vp-p, 75 Ω terminator (positive) H/V. sync.: TTL level (positive/negative)
		2	Composite sync.: TTL level D-sub 15-pin shrink jack
	DVI		TMDS, DC: 150-1200 mV / AC: 1.56 Vp-p TTL Level (Positive/Negative)
	AUDIO IN	RGB1	200m Vrms, 50 kΩ (max. 3.0Vp-p) Stereo mini jack
DVI			
RGB2			
Video signal input	VIDEO		1.0Vp-p, 75 Ω terminator RCA jack
	S-VIDEO		Brightness signal: 1.0 Vp-p, 75 Ω terminator Color signal: 0.286Vp-p (burst signal), 75 Ω terminator Mini DIN 4-pin jack
	COMPONENT VIDEO	Y	1.0 Vp-p, 75 Ω Terminator (positive)
		C <sub>B</sub> /P <sub>B</sub>	0.7 Vp-p, 75 Ω Terminator (positive)
		C <sub>R</sub> /P <sub>R</sub>	0.7 Vp-p, 75 Ω Terminator (positive)
	AUDIO	L/MONO	200m Vrms, 50 kΩ (max. 3.0 Vp-p) RCA jack
R			
Signal output	RGB OUT		Video: Analog 0.7 Vp-p, 75 Ω output impedance (positive) H/V. sync.: TTL level (positive/negative) Composite sync.: TTL level D-sub 15-pin shrink jack
	AUDIO OUT		200m Vrms, output impedance 1 kΩ (max. 3.0Vp-p) Stereo mini jack
Control functions	CONTROL		D-sub 15-pin shrink plug
	USB		USB jack (B type)
Optional parts		Lamp: PRJ-RLC--002	

**NOTE:** • These specifications are subject to change without notice.

# Customer Support

For technical support or product service, see the table below or contact your reseller.

**NOTE:** You will need the product serial number.

Country/Region	Web site	T = Telephone F = FAX	Email
United States	viewsonic.com/support	T: (800) 688-6688 F: (909) 468-1202	service.us@ viewsonic.com
Canada	viewsonic.com/support	T: (800) 688-6688 F: (909) 468-1202	service.ca@ viewsonic.com
United Kingdom	viewsoniceurope.com	T: 0800 833 648 F: (01293) 643910	service.eu@ viewsoniceurope.com
Europe, Middle East, Baltic countries, and North Africa	viewsoniceurope.com	Contact your reseller	service.eu@ viewsoniceurope.com
Australia and New Zealand	viewsonic.com.au	T: +61 2 9929 3955 F: +61 2 9929 8393	service.au@ viewsonic.com
Singapore/India and Southeast Asia	viewsonic.com.sg	T: 65 273 4018 F: 65 273 1566	service.sg@ viewsonic.com
Other Asia/Pacific countries	viewsonic.com.tw	T: 886 2 2246 3456 F: 886 2 8242 3668	service.ap@ viewsonic.com
South Africa	viewsonic.com/asia	T: 886 2 2246 3456 F: 886 2 8242 3668	service.ap@ viewsonic.com

# LIMITED WARRANTY

## VIEWSONIC Projector

### What the warranty covers:

**ViewSonic®** warrants its products to be free from defects in material and workmanship during the warranty period. If a product proves to be defective in material or workmanship during the warranty period, **ViewSonic** will at its sole option repair or replace the product with a like product. Replacement product or parts may include remanufactured or refurbished parts or components.

### How long the warranty is effective:

**ViewSonic** projectors are warranted for two (2) years for all parts excluding the lamp, two (2) years for all labor, and ninety (90) days for the lamp from the date of the first consumer purchase.

### Who the warranty protects:

This warranty is valid only for the first consumer purchaser.

### What the warranty does not cover:

1. Any product on which the serial number has been defaced, modified or removed.
2. Damage, deterioration or malfunction resulting from:
  - a. Accident, misuse, neglect, fire, water, lightning, or other acts of nature, unauthorized product modification, or failure to follow instructions supplied with the product.
  - b. Repair or attempted repair by anyone not authorized by **ViewSonic**.
  - c. Any damage of the product due to shipment.
  - d. Removal or installation of the product.
  - e. Causes external to the product, such as electric power fluctuations or failure.
  - f. Use of supplies or parts not meeting **ViewSonic's** specifications.
  - g. Normal wear and tear.
  - h. Any other cause which does not relate to a product defect.
3. Removal, installation, and set-up service charges.

### How to get service:

1. For information about receiving service under warranty, contact **ViewSonic Customer Support**. You will need to provide your product's serial number.
2. To obtain warranted service, you will be required to provide (a) the original dated sales slip, (b) your name, (c) your address, (d) a description of the problem, and (e) the serial number of the product.
3. Take or ship the product freight prepaid in the original container to an authorized **ViewSonic** service center or **ViewSonic**.
4. For additional information or the name of the nearest **ViewSonic** service center, contact **ViewSonic**.

### Limitation of implied warranties:

THERE ARE NO WARRANTIES, EXPRESS OR IMPLIED, WHICH EXTEND BEYOND THE DESCRIPTION CONTAINED HEREIN INCLUDING THE IMPLIED WARRANTY OF MERCHANTABILITY AND FITNESS FOR A PARTICULAR PURPOSE.

### Exclusion of damages:

**VIEWSONIC'S** LIABILITY IS LIMITED TO THE COST OF REPAIR OR REPLACEMENT OF THE PRODUCT.

### **VIEWSONIC** SHALL NOT BE LIABLE FOR:

1. DAMAGE TO OTHER PROPERTY CAUSED BY ANY DEFECTS IN THE PRODUCT, DAMAGES BASED UPON INCONVENIENCE, LOSS OF USE OF THE PRODUCT, LOSS OF TIME, LOSS OF PROFITS, LOSS OF BUSINESS OPPORTUNITY, LOSS OF GOODWILL, INTERFERENCE WITH BUSINESS RELATIONSHIPS, OR OTHER COMMERCIAL LOSS, EVEN IF ADVISED OF THE POSSIBILITY OF SUCH DAMAGES.
2. ANY OTHER DAMAGES, WHETHER INCIDENTAL, CONSEQUENTIAL OR OTHERWISE.
3. ANY CLAIM AGAINST THE CUSTOMER BY ANY OTHER PARTY.

### Effect of state law:

This warranty gives you specific legal rights, and you may also have other rights which vary from state to state. Some states do not allow limitations on implied warranties and/or do not allow the exclusion of incidental or consequential damages, so the above limitations and exclusions may not apply to you.

### Sales outside the U.S.A. and Canada:

For warranty information and service on **ViewSonic** products sold outside of the U.S.A. and Canada, contact **ViewSonic** or your local **ViewSonic** dealer.

# Appendix

## Power Cord Safety Guidelines

**Caution:** Use a power cable that is properly grounded. Always use an AC power cord that meets your country's safety standard.

USA.....	UL	Switzerland .....	SEV
Canada.....	CSA	Britain.....	BASE/BS
Germany.....	VDE	Japan .....	Electric Appliance Control Act

### AC PLUG CORD PRECAUTIONS FOR THE UNITED KINGDOM

FOR YOUR SAFETY PLEASE READ THE FOLLOWING TEXT CAREFULLY.

IF THE FITTED MOULDED PLUG IS UNSUITABLE FOR THE SOCKET OUTLET THEN THE PLUG SHOULD BE CUT OFF AND DISPOSED OF SAFELY.

THERE IS A DANGER OF SEVERE ELECTRICAL SHOCK IF THE CUT OFF PLUG IS INSERTED INTO AN APPROPRIATE SOCKET.

If a new plug is to be fitted, please observe the wiring code as shown below.

If in any doubt, please consult a qualified electrician.

**WARNING:** THIS APPLIANCE MUST BE EARTHED.

**IMPORTANT:** The wires in this mains lead are coloured in accordance with the following code:

Green-and-Yellow:	Earth
Blue:	Neutral
Brown:	Live

If the coloured wires of the mains lead of this appliance do not correspond with the coloured markings identifying the terminals in your plug, proceed as follows:

The wire which is coloured GREEN-AND-YELLOW must be connected to the terminal in the plug which is marked by the letter E or by the Earth symbol or coloured GREEN or GREEN-AND-YELLOW.

The wire which is coloured BLUE must be connected to the terminal in the plug which is marked with the letter N or coloured BLACK. The wire which is coloured BROWN must be connected to the terminal in the plug which is marked with the letter L or coloured RED.

### IMPORTANT NOTICE CONCERNING POWER CORD SELECTION

The power cord set for this unit has been enclosed and has been selected according to the country of destination and must be used to prevent electric shock. Use the following guidelines if it is necessary to replace the original cord set, or if the cord set is not enclosed.

The female receptacle of the cord set must meet CEE-22 requirements and may look like (Figure A1 below):

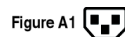

### For the United States and Canada

In the United States and Canada the male plug is a NEMA5-15 style (Figure A2), UL Listed, and CSA Labeled. For units which are mounted on a desk or table, type SVT or SJT cord sets may be used. For units which sit on the floor, only SJT type cord sets may be used. The cord set must be selected according to the current rating for your unit. Please consult the table below for the selection criteria for power cords used in the United States and Canada.



### For the customer in Canada

Notice: This Class B digital apparatus complies with Canadian ICES-003.

Cord Type	Size of Conductors in Cord	Maximum Current Rating of Unit
SJT	18 AWG 16 AWG 14 AWG	10 Amps 12 Amps 12 Amps
SVT	18 AWG 17 AWG	10 Amps 12 Amps

### For European Countries

In Europe you must use a cord set which is appropriate for the receptacles in your country. The cord set is HAR-Certified, and a special mark that will appear on the outer sheath, or on the insulation of one of the inner conductors. If you have any questions concerning which proper power cord to use, please consult with the dealer from whom you have purchased the product.

## FCC Information

This equipment has been tested and found to comply with the limits for a Class B digital device, pursuant to part 15 of the FCC Rules. These limits are designed to provide reasonable protection against harmful interference in a residential installation. This equipment generates, uses, and can radiate radio frequency energy, and if not installed and used in accordance with the instructions, may cause harmful interference to radio communications. However, there is no guarantee that interference will not occur in a particular installation. If this equipment does cause harmful interference to radio or television reception, which can be determined by turning the equipment off and on, the user is encouraged to try to correct the interference by one or more of the following measures:

- Reorient or relocate the receiving antenna.
- Increase the separation between the equipment and receiver.
- Connect the equipment into an outlet on a circuit different from that to which the receiver is connected.
- Consult the dealer or an experienced radio/TV technician for help.

### FCC Warning

To assure continued FCC compliance, the user must use grounded power supply cord and the provided shielded video interface cable with bonded ferrite cores. If a BNC cable is going to be used, use only a shielded BNC(5) cable. Also, any unauthorized changes or modifications not expressly approved by the party responsible for compliance could void the user's authority to operate this device.

### Instructions to Users

This equipment complies with the requirements of FCC (Federal Communication Commission) equipment provided that the following condition is met. Use the cables which are included with the projector or specified.

## Compliance Information for Canada

**Notice:** This class B digital apparatus complies with Canadian ICES-003.

**AVIS:** Cet appareil numérique de la Classe B conforme a la norme NMB-003 du Canada.

## Compliance Information for European Countries

### CE Conformity



The device complies with the requirements of the EEC directive 89/336/EEC as amended by 92/31/EEC and 93/68/EEC Art.5 with regard to "Electromagnetic compatibility," and 73/23/EEC as amended by 93/68/EEC Art.13 with regard to "Safety."

## User Information for All Countries

**NOTICE:** Use the cables which are included with the projector or specified.

**ViewSonic Corporation**