

Multimedia Projector

MODEL PLV-HD10

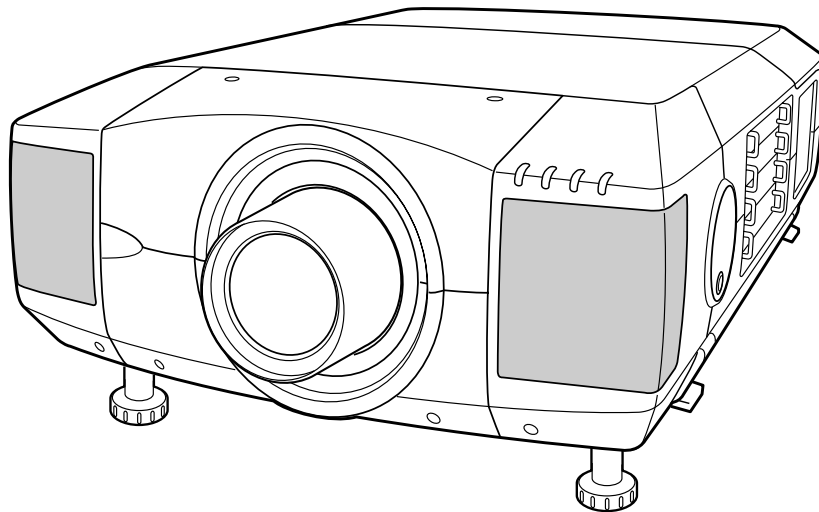

* Projection lens is optional.

Owner's Manual

TO THE OWNER

Before operating this projector, read this manual thoroughly and operate the projector properly.

This projector provides many convenient features and functions. Operating the projector properly enables you to manage those features and maintains it in better condition for a considerable time.

Improper operation may result in not only shortening the product-life, but also malfunctions, fire hazard, or other accidents.

If your projector seems to operate improperly, read this manual again, check operations and cable connections and try the solutions in the "Trouble-shooting" section of the end of this booklet. If the problem still persists, contact the sales dealer where you purchased the projector or the service center.



SAFETY PRECAUTIONS

WARNING : TO REDUCE THE RISK OF FIRE OR ELECTRIC SHOCK, DO NOT EXPOSE THIS APPLIANCE TO RAIN OR MOISTURE.

- This projector produces intense light from the projection lens. Do not stare directly into the lens as possible. Eye damage could result. Be especially careful that children do not stare directly into the beam.
- This projector should be set in the way indicated. If not, it may result in a fire hazard.
- Take appropriate space on the top, sides and rear of the projector cabinet for allowing air circulation and cooling the projector. Minimum distance should be taken. If the projector is to be built into a compartment or similarly enclosed, the minimum distances must be maintained. Do not cover the ventilation slot on the projector. Heat build-up can reduce the service life of your projector, and can also be dangerous.
- Do not put any flammable object or spray can near the projector, hot air is exhausted from the ventilation holes.
- If the projector is not to be used for an extended time, unplug the projector from the power outlet.

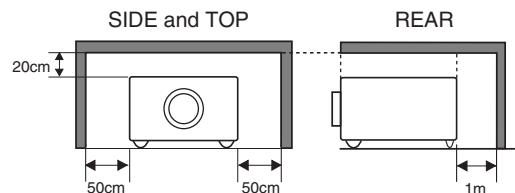

READ AND KEEP THIS OWNER'S MANUAL FOR LATER USE.

CAUTION

Not for use in a computer room as defined in the Standard for the Protection of Electronic Computer/Data Processing Equipment, ANSI/NFPA 75.

Ne puet être utilisé dans une salle d'ordinateurs telle que définie dans la norme ANSI/NFPA 75 Standard for Protection of Electronic Computer/Data Processing Equipment

	CAUTION RISK OF ELECTRIC SHOCK DO NOT OPEN	
CAUTION : TO REDUCE THE RISK OF ELECTRIC SHOCK, DO NOT REMOVE COVER (OR BACK). NO USER-SERVICEABLE PARTS INSIDE EXCEPT LAMP REPLACEMENT. REFER SERVICING TO QUALIFIED SERVICE PERSONNEL.		
THIS SYMBOL INDICATES THAT DANGEROUS VOLTAGE CONSTITUTING A RISK OF ELECTRIC SHOCK IS PRESENT WITHIN THIS UNIT.	THIS SYMBOL INDICATES THAT THERE ARE IMPORTANT OPERATING AND MAINTENANCE INSTRUCTIONS IN THE OWNER'S MANUAL WITH THIS UNIT.	

SAFETY INSTRUCTIONS

All the safety and operating instructions should be read before the product is operated.

Read all of the instructions given here and retain them for later use. Unplug this projector from AC power supply before cleaning. Do not use liquid or aerosol cleaners. Use a damp cloth for cleaning.

Follow all warnings and instructions marked on the projector.

For added protection to the projector during a lightning storm, or when it is left unattended and unused for long periods of time, unplug it from the wall outlet. This will prevent damage due to lightning and power line surges.

Do not expose this unit to rain or use near water... for example, in a wet basement, near a swimming pool, etc...

Do not use attachments not recommended by the manufacturer as they may cause hazards.

Do not place this projector on an unstable cart, stand, or table. The projector may fall, causing serious injury to a child or adult, and serious damage to the projector. Use only with a cart or stand recommended by the manufacturer, or sold with the projector. Wall or shelf mounting should follow the manufacturer's instructions, and should use a mounting kit approved by the manufacturers.

An appliance and cart combination should be moved with care. Quick stops, excessive force, and uneven surfaces may cause the appliance and cart combination to overturn.



Slots and openings in the back and bottom of the cabinet are provided for ventilation, to insure reliable operation of the equipment and to protect it from overheating.

The openings should never be covered with cloth or other materials, and the bottom opening should not be blocked by placing the projector on a bed, sofa, rug, or other similar surface. This projector should never be placed near or over a radiator or heat register.

This projector should not be placed in a built-in installation such as a book case unless proper ventilation is provided.

Never push objects of any kind into this projector through cabinet slots as they may touch dangerous voltage points or short out parts that could result in a fire or electric shock. Never spill liquid of any kind on the projector.

This projector should be operated only from the type of power source indicated on the marking label. If you are not sure of the type of power supplied, consult your authorized dealer or local power company.

Do not overload wall outlets and extension cords as this can result in fire or electric shock. Do not allow anything to rest on the power cord. Do not locate this projector where the cord may be damaged by persons walking on it.

Do not attempt to service this projector yourself as opening or removing covers may expose you to dangerous voltage or other hazards. Refer all servicing to qualified service personnel.

Unplug this projector from wall outlet and refer servicing to qualified service personnel under the following conditions:

- a. When the power cord or plug is damaged or frayed.
- b. If liquid has been spilled into the projector.
- c. If the projector has been exposed to rain or water.
- d. If the projector does not operate normally by following the operating instructions. Adjust only those controls that are covered by the operating instructions as improper adjustment of other controls may result in damage and will often require extensive work by a qualified technician to restore the projector to normal operation.
- e. If the projector has been dropped or the cabinet has been damaged.
- f. When the projector exhibits a distinct change in performance-this indicates a need for service.

When replacement parts are required, be sure the service technician has used replacement parts specified by the manufacturer that have the same characteristics as the original part. Unauthorized substitutions may result in fire, electric shock, or injury to persons.

Upon completion of any service or repairs to this projector, ask the service technician to perform routine safety checks to determine that the projector is in safe operating condition.

Voor de klanten in Nederland



Bij dit product zijn batterijen geleverd. Wanneer deze leeg zijn, moet u ze niet weggooien maar inleveren als KCA.

COMPLIANCES

Federal Communication Commission Notice

This equipment has been tested and found to comply with the limits for a Class A digital device, pursuant to Part 15 of FCC Rules. These limits are designed to provide reasonable protection against harmful interference when the equipment is operated in a commercial environment. This equipment generates, uses, and can radiate radio frequency energy and, if not installed and used in accordance with the instruction manual, may cause harmful interference to radio communications. Operation of this equipment in a residential area is likely to cause harmful interference in which case the user will be required to correct the interference at his own expense.

Do not make any changes or modifications to the equipment unless otherwise specified in the instructions. If such changes or modifications should be made, you could be required to stop operation of the equipment.

CAUTION!

This is a Class A equipment. This equipment can cause interference in residential areas; in this case, the operator can be asked to take adequate countermeasures.

AC POWER CORD REQUIREMENT

The AC Power Cord supplied with this projector meets the requirement for use in the country you purchased it.

AC Power Cord for the United States and Canada :

AC Power Cord used in the United States and Canada is listed by the Underwriters Laboratories (UL) and certified by the Canadian Standard Association (CSA).

AC Power Cord has a grounding-type AC line plug. This is a safety feature to be sure that the plug will fit into the power outlet. Do not try to defeat this safety feature. Should you be unable to insert the plug into the outlet, contact your electrician.

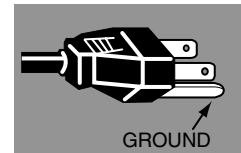

AC Power Cord for the United Kingdom :

This cord is already fitted with a moulded plug incorporating a fuse, the value of which is indicated on the pin face of the plug. Should the fuse need to be replaced, an ASTA approved BS 1362 fuse must be used of the same rating, marked thus Ⓢ . If the fuse cover is detachable, never use the plug with the cover omitted. If a replacement fuse cover is required, ensure it is of the same colour as that visible on the pin face of the plug (i.e. red or orange). Fuse covers are available from the Parts Department indicated in your User Instructions. If the plug supplied is not suitable for your socket outlet, it should be cut off and destroyed.

The end of the flexible cord should be suitably prepared and the correct plug fitted. (See Over)

WARNING : A PLUG WITH BARED FLEXIBLE CORD IS HAZARDOUS IF ENGAGED IN A LIVE SOCKET OUTLET.

The Wires in this mains lead are coloured in accordance with the following code:

Green-and-yellow Earth
Blue Neutral
Brown Live

As the colours of the wires in the mains lead of this apparatus may not correspond with the coloured markings identifying the terminals in your plug proceed as follows:

The wire which is coloured green-and-yellow must be connected to the terminal in the plug which is marked by the letter E or by the safety earth symbol \perp or coloured green or green-and-yellow.

The wire which is coloured blue must be connected to the terminal which is marked with the letter N or coloured black.

The wire which is coloured brown must be connected to the terminal which is marked with the letter L or coloured red.

WARNING : THIS APPARATUS MUST BE EARTHED.

THE SOCKET-OUTLET SHOULD BE INSTALLED NEAR THE EQUIPMENT AND EASILY ACCESSIBLE.

TABLE OF CONTENTS

FEATURES AND DESIGN	6	DISPLAY ADJUST	28
PREPARATION	7	DISPLAY ADJUSTMENTS	28
NAME OF EACH PART OF PROJECTOR	7	SCREEN ADJUSTMENTS	28
SETTING-UP PROJECTOR	8	AUTO PC ADJUSTMENT	29
CONNECTING AC POWER CORD	8	MANUAL DISPLAY ADJUSTMENTS	30
LENS INSTALLATION	9	IMAGE ADJUSTMENTS	32
POSITIONING PROJECTOR	9	IMAGE LEVEL SELECT	32
LENS SHIFT ADJUSTMENT	9	IMAGE LEVEL ADJUSTMENTS	33
PICTURE LEVEL AND TILT ADJUSTMENT	10	SETTING	35
MOVING PROJECTOR	10	SETTING MENU	35
CONNECTING PROJECTOR	11	APPENDIX	39
TERMINALS OF PROJECTOR	11	MAINTENANCE	39
CONNECTING TO COMPUTER	14	WARNING TEMP. INDICATOR	39
CONNECTING TO VIDEO EQUIPMENT	15	AIR FILTER CARE AND CLEANING	39
BEFORE OPERATION	16	LAMP MANAGEMENT	40
SIDE CONTROLS AND INDICATORS	16	LAMP REPLACEMENT	41
OPERATION OF REMOTE CONTROL	18	CLEANING PROJECTION LENS	42
REMOTE CONTROL CODE CHANGE		TROUBLESHOOTING	43
AND OPERATING RANGE	19	INDICATORS AND PROJECTOR CONDITION	45
REMOTE CONTROL BATTERIES INSTALLATION	19	MENU TREE	46
OPERATING ON-SCREEN MENU	20	TECHNICAL SPECIFICATIONS	48
HOW TO OPERATE ON-SCREEN MENU	20	CONFIGURATIONS OF TERMINALS	49
FLOW OF ON-SCREEN MENU OPERATION	20	COMPATIBLE COMPUTER SPECIFICATIONS	50
MENU BAR	21	OPTIONAL PARTS	51
BASIC OPERATION	22		
TURNING ON / OFF PROJECTOR	22		
ADJUSTING SCREEN	23		
ZOOM ADJUSTMENT	23		
FOCUS ADJUSTMENT	23		
LENS SHIFT ADJUSTMENT	23		
PICTURE FREEZE FUNCTION	23		
NO SHOW FUNCTION	23		
SOUND ADJUSTMENT	24		
SELECTING INPUT SOURCE	25		
SYSTEM SELECT	26		
AUTOMATIC MULTI-SCAN SYSTEM	26		
SELECT COMPUTER SYSTEM MANUALLY	26		
SELECT VIDEO SYSTEM	27		

TRADEMARKS

- Apple, Macintosh, and PowerBook are trademarks or registered trademarks of Apple Computer, Inc.
- IBM and PS/2 are trademarks or registered trademarks of International Business Machines, Inc.
- Windows and PowerPoint are registered trademarks of Microsoft Corporation.
- Each name of corporations or products in the owner's manual is a trademark or a registered trademark of its respective corporation.

FEATURES AND DESIGN

This Multimedia Projector is designed with most advanced technology for portability, durability, and ease of use. This projector utilizes built-in multimedia features, a palette of 16.77 million colors, and matrix liquid crystal display (LCD) technology.

◆ Compatibility

This projector widely accepts various video and computer input signals including;

- **Computers**
IBM-compatible or Macintosh computer up to 1600 x 1200 resolution.
- **6 Color Systems**
NTSC, PAL, SECAM, NTSC 4.43, PAL-M or PAL-N color system can be connected.
- **Component Video**
Component video signal, such as a DVD player output high definition TV signals including 480i, 480p, 575i, 575p, 720p, 1035i, 1080i-50 or 1080i-60, can be connected.
- **S-Video**
S-Video signal, such as a S-VHS VCR output signal, can be connected.

◆ High Resolution Image

This projector provides 1920 x 1080 dots resolution for computer input and 1100 horizontal TV lines. This projector cannot display image of over 1600 x 1200 dots. When resolution of your computer is over than 1600 x 1200, reset a computer output for lower resolution.

◆ Multi-Scan System

This projector has Multi-Scan System to conform to almost all computer output signals quickly. There is no need for troublesome manual adjustment of frequency and other settings.

◆ One-Touch Auto PC Adjustment

Incoming computer video signals are recognized and best adjustment is automatically set by Auto PC Adjustment. No complicated setup is necessary and projection is always precise.

◆ Progressive Scan Function

This function converts interlace video signals into progressive scan signals and provide fine picture quality.

◆ Motor-driven Lens Shift

Projection lens can be moved up, down left and right with motor-driven lens shift function. This function makes it easy to provide projected image where you want. Zoom and focus can be also adjusted with motor-driven operation.

◆ Power Management

Power Management function is provided to reduce power consumption while a projector is not in use.

This Power Management function operates to turn Projection Lamp off when a projector detects signal interruption and any button is not pressed. Projection Lamp is automatically turned on again when a projector detects signal or any operation button is pressed.

This projector is shipped with this function ON.

◆ Digital Visual Interface

This projector is equipped with DVI 29-pin terminal for connecting DVI output from a computer.

◆ Multi Versatile Platform

This projector applies various input/output terminals and 4 terminal slots for expansion to tune to diversity of signals from computers and video equipment.

◆ Selectable Terminal Slots

4-built-in Terminal Slots enable you to arrange any combinations of input sources just by changing Terminal Boards. For Terminal Boards, contact sales dealer where you purchased a projector.

◆ Multilanguage Menu Display

Operation menu is displayed in; English, German, French, Italian, Spanish, Portuguese, Dutch, Swedish, Chinese, Korean or Japanese.

◆ Network board (Optional)

Network board is an optional product to control and set up a projector via the network cable. By accessing to the connected projector using the web browser on your computer. It can be controlled and set up the projector remotely. Contact the sales dealer where you purchased this projector for optional parts.

PREPARATION

NAME OF EACH PART OF PROJECTOR

FRONT OF CABINET

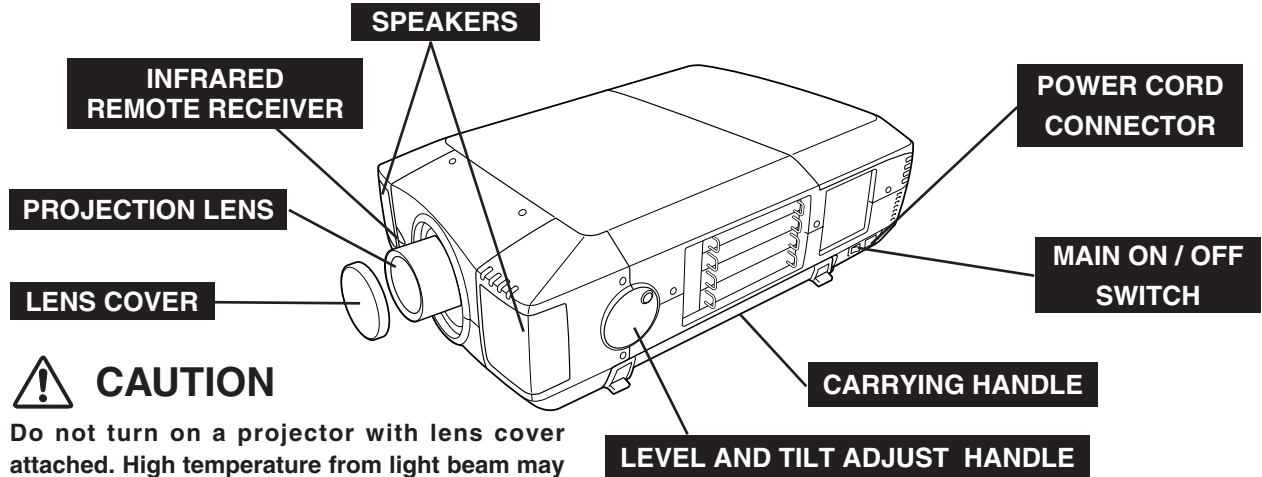

CAUTION

Do not turn on a projector with lens cover attached. High temperature from light beam may damage lens cover and result in fire hazard.

BACK OF CABINET

EXHAUST VENT

HOT AIR EXHAUSTED !

Air blown from exhaust vent is hot. When using or installing a projector, following precautions should be taken.

- Do not put a flammable object near this vent.
- Keep rear grills at least 3.3' (1m) away from any object, especially heat-sensitive object.
- Do not touch this area, especially screws and metallic parts. This area will become hot while a projector is used.

This projector detects internal temperature and automatically controls operating power of Cooling Fans.

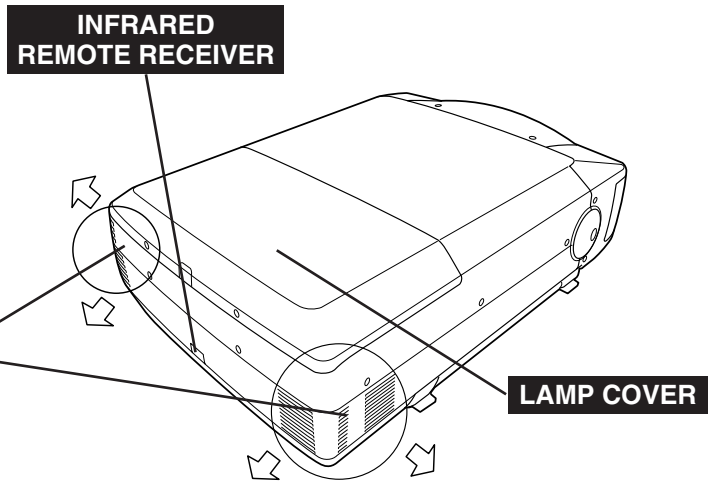

BOTTOM OF CABINET

AIR INTAKE VENTS

This projector is equipped with cooling fans for protection from overheating. Pay attention to following to ensure proper ventilation and avoid a possible risk of fire and malfunction.

- Do not cover vent slots.
- Keep bottom clear of any objects. Obstructions may block cooling air.

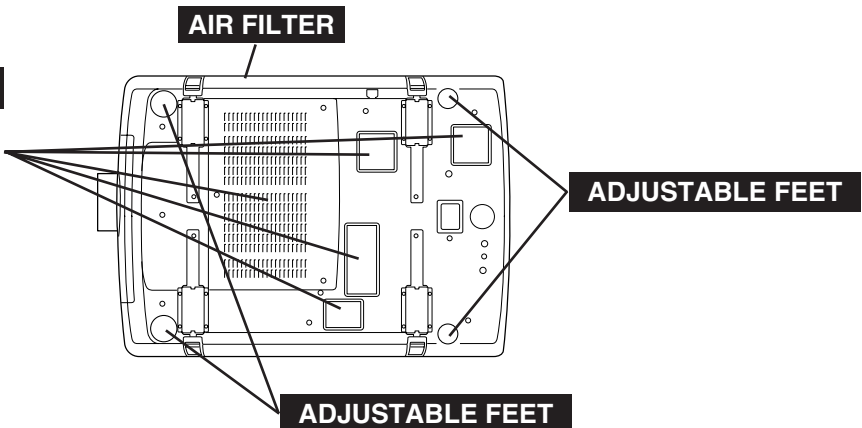

SETTING-UP PROJECTOR

CONNECTING AC POWER CORD

This projector uses nominal input voltages of 120 V or 200-240 V AC. This projector automatically selects correct input voltage. It is designed to work with single-phase power systems having a grounded neutral conductor. To reduce risk of electrical shock, do not plug into any other type of power system. Consult your authorized dealer or service station if you are not sure of type of power supply being in use. Connect a projector with peripheral equipment before turning a projector on. (Refer to pages 12 ~ 15 for connection.)

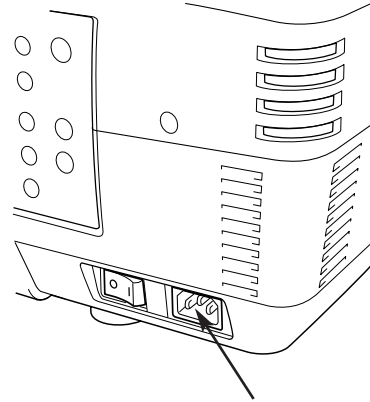

Connect AC Power Cord (supplied) to a projector.
AC outlet must be near this equipment and must be easily accessible.

NOTE ON POWER CORD

AC Power Cord must meet requirement of country where you use a projector. Confirm AC plug type with chart below and proper AC power cord must be used. If supplied AC Power Cord does not match AC outlet, contact your sales dealer.

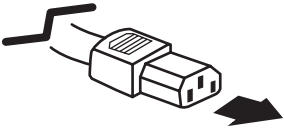
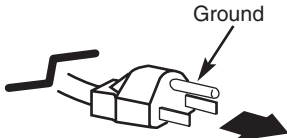
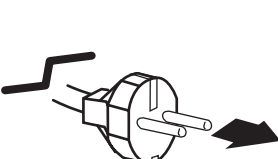
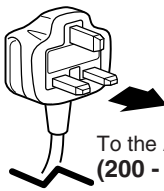
Projector side	AC Outlet side		
 <p data-bbox="240 1411 428 1486">To POWER CORD CONNECTOR on a projector.</p>	<p data-bbox="495 1213 792 1243">For the U.S.A. and Canada</p>  <p data-bbox="625 1417 792 1474">To the AC Outlet. (120 V AC)</p>	<p data-bbox="828 1213 1128 1243">For Continental Europe</p>  <p data-bbox="950 1438 1128 1495">To the AC Outlet. (200 - 240 V AC)</p>	<p data-bbox="1226 1213 1388 1243">For the U.K.</p>  <p data-bbox="1274 1411 1464 1467">To the AC Outlet. (200 - 240 V AC)</p>

LENS INSTALLATION

Before setting up a projector, install Projection Lens on a Projector.

1. Before installation, check where a projector is used and prepare suitable lens. For specifications of Projection Lens, refer to manual separately attached or contact sales dealer where you purchased a projector.
2. For installation, refer to installation manual supplied to a Projector.



When moving or setting up a projector, be sure to replace a Lens Cover to protect a surface. And be careful not to hold or subject a lens to strong forces. It may damage lens, cabinet, or mechanical parts.

POSITIONING PROJECTOR

This projector is designed to project on a flat projection surface.

ROOM LIGHT

Brightness in room has a great influence on picture quality. It is recommended to limit ambient lighting in order to provide best image.

VENTILATION

This projector is equipped with cooling fan to protect it from overheating. Pay attention to following to ensure proper ventilation and avoid a possible risk of fire and malfunction.



- Do not cover vents with papers or other materials.
- Keep rear grill at least 3.3 feet (1 m) away from any object.
- Make sure that there are no objects under a projector. An object under a projector may prevent a projector from taking cooling air through bottom vent.

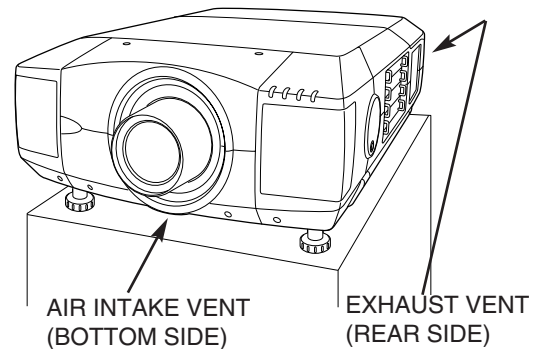
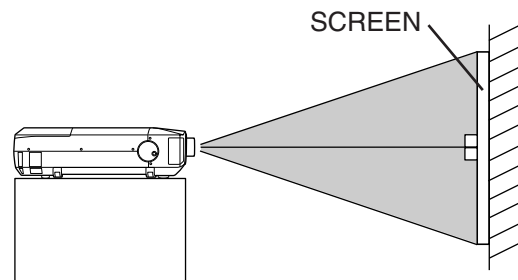

LENS SHIFT ADJUSTMENT

Projection lens can be moved up, down, left and right with motor-driven lens shift function. This function makes it easy to provide projected image where you want.

Use LENS SHIFT button and POINT UP/DOWN button to move image up or down. (Refer to page 23.)

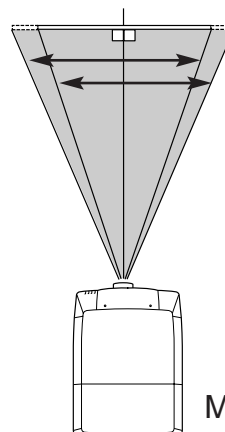
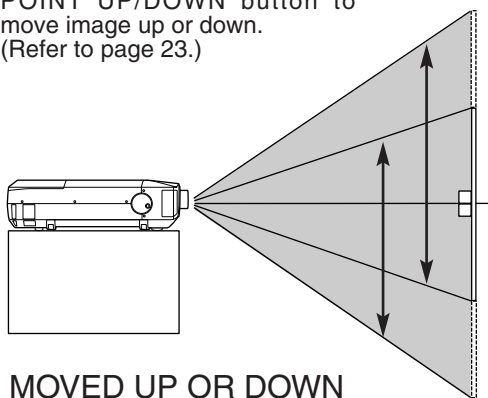

Use LENS SHIFT button and POINT LEFT/RIGHT button to move image left or right. (Refer to page 23.)

PICTURE LEVEL AND TILT ADJUSTMENT

Picture tilt and projection angle can be adjusted with handles on both sides of a projector. Projection angle can be adjusted to 5.7 degrees upper way.

- 1 Press knob on handle. Handle pop out.
- 2 Turn handles (right and left) until picture is projected on proper position. Adjust height of rear adjustable feet by rotating them until projector properly stabled on table.
- 3 Press knob and retract handle.

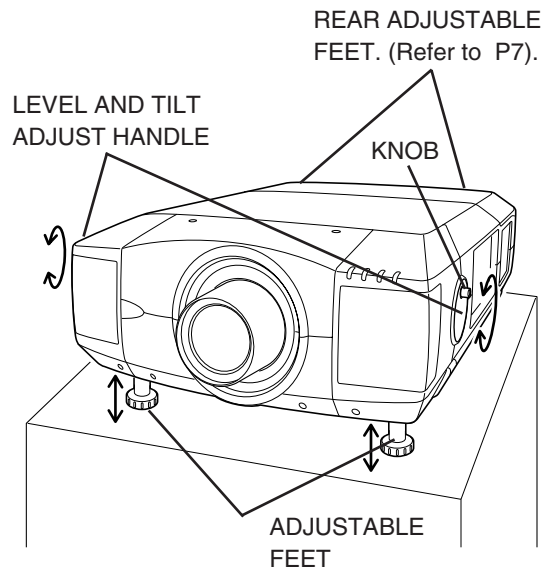

Height of front feet can be adjusted by turning handles.

MOVING PROJECTOR



For safety, be sure to hold Carrying Handles on both sides by 2 or more people when moving a projector. Moving it improperly may result in damage of cabinet or person's injury. Replace lens cover and retract feet to prevent damage to lens and cabinet.

- 1 Pull up lock buttons on each side of carrying handles and release locks.
- 2 Pull carrying handles out fully until it's locked (with a click). Move a projector by holding two handles by 2 or more people.
- 3 To retract carrying handles, pull up lock buttons and release lock of handles and press handles fully in until it's locked.

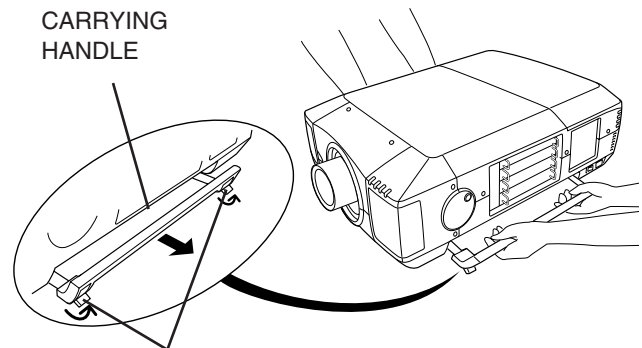

Pull up lock buttons to release lock.



CAUTION IN CARRYING OR TRANSPORTING A PROJECTOR

- Do not drop or bump a projector, otherwise damages or malfunctions may result.
- When carrying a projector, use a suitable carrying case.
- Do not transport a projector by using a courier or transport service in an unsuitable transport case. This may cause damage to a projector. To transport a projector through a courier or transport service, consult your dealer and best case should be applied.

CONNECTING PROJECTOR

TERMINALS OF PROJECTOR

This projector applies various input/output terminals and 4 terminal slots for expansion to tune to diversity of signals from computers and video equipment. 4-built-in Terminal Slots enable you to arrange desired combinations of input sources just by changing Terminal Boards. For Terminal Boards, contact sales dealer where you purchased a projector.

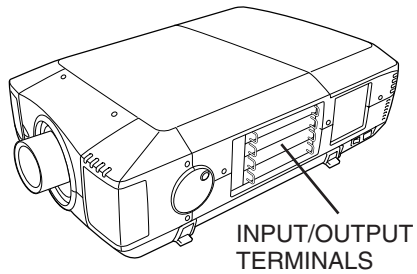

3 TERMINAL SLOTS (Factory set)

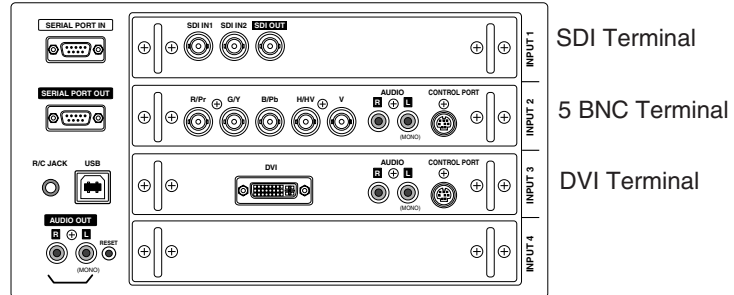

REPLACEMENT OF TERMINAL

NOTE; When replacement of terminal board, **MAIN ON/OFF switch should be OFF position.**

- 1 Remove 2 Screws on terminal.
- 2 Pull out terminal by holding handle.
- 3 Replace terminal. Insert terminal along Guide to fit Plug into Socket.
- 4 Tighten screws to secure terminal.

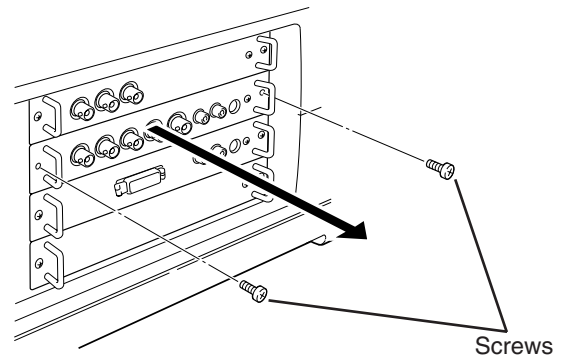

NOTES ON ORDERING OR USING OPTIONAL INTERFACE BOARD

When ordering or using Optional Interface Board (Terminal Board), contact your sales dealer. When contacting the sales dealer, tell the Optional Control Number (Op.cont.No.) in the menu that is located under Language Select Menu. (See page 35.)

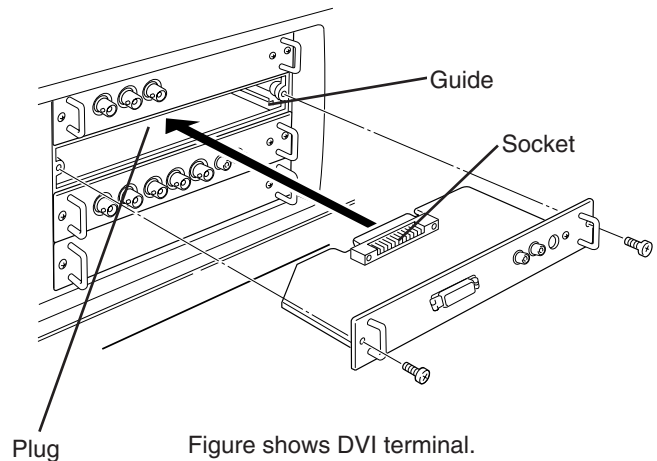

INPUT/OUTPUT TERMINALS AND JACKS

INPUT 1

SDI INPUT JACKS

Connect SDI output from video equipment to these jacks. (Refer to P15.)

INPUT 1

SDI OUTPUT JACK

Connect SDI input from video equipment to this jack. (Refer to P15.)

INPUT 2, 3

AUDIO INPUT JACKS

Connect audio output from computer or video equipment to these jacks. (Refer to P14, 15.)

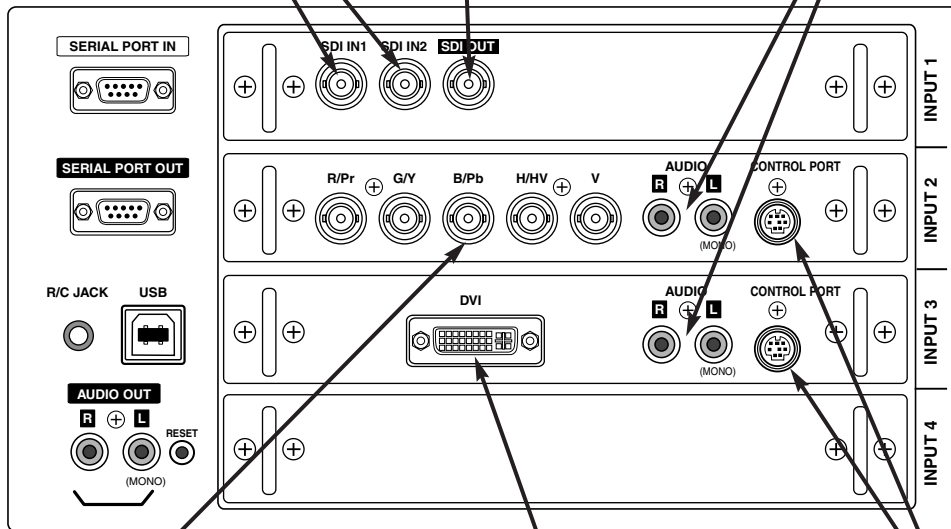

INPUT 2

5 BNC INPUT JACKS

Connect component video output (Cr, Y, Cb or Pr, Y, Pb) from video equipment to R/Pr, G/Y and B/Pb jacks or connect computer output [5 BNC Type (Red, Green, Blue, Horiz. Sync and Vert. Sync.)] from computer to R/Pr, G/Y, B/Pb, H/HV and V jacks. (Refer to P14, 15)

INPUT 3

DVI INPUT TERMINAL

Connect computer output (Digital/Analog DVI-I type) to this terminal. Connect digital video output from video equipment to this terminal. (Refer to P14, 15.)

INPUT 2, 3,

CONTROL PORT CONNECTORS

The port is not functioning in this model.

SERIAL PORT IN TERMINAL

If you control a projector by computer, you must connect a cable (not provided) from your computer to this terminal.

USB PORT (Series B)

This port is used to control a projector with computer. Connect USB port of computer to this port.

SERIAL PORT OUT TERMINAL

This terminal outputs signal from SERIAL PORT IN. More than two projectors can be controlled with one computer by connecting SERIAL PORT IN. of another projector to this terminal.

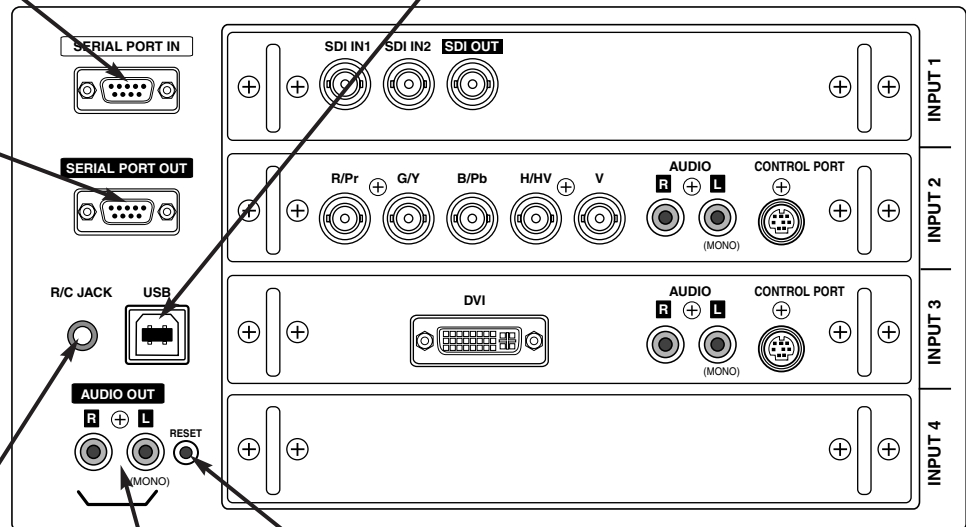

R/C JACK

When using Wired / Wireless Remote Control Unit as Wired Remote Control, Connect Wired Remote Control Unit to this jack with Remote Control Cable (supplied). (Refer to page 18.)

RESET BUTTON

This projector uses a micro processor to control unit. Occasionally, micro processor may malfunction and need to be reset. This can be done by pressing RESET button with a pen, which will shut down and restart unit. Do not use RESET function excessively.

AUDIO OUTPUT JACKS

Connect an external audio amplifier to these jacks. (Refer to P14, 15.)

CONNECTING TO COMPUTER

Cables used for connection (* = Cables are not supplied with this projector.)

- DVI Cable
- DVI-VGA Cable (HDB 15 pin)
- MAC/VGA Adapter
- BNC Cable (BNC x 5) *
- Audio Cables (RCA x 2) *



NOTE :

When connecting cable, power cords of both a projector and external equipment should be disconnected from AC outlet. Turn a projector and peripheral equipment on before computer is switched on.

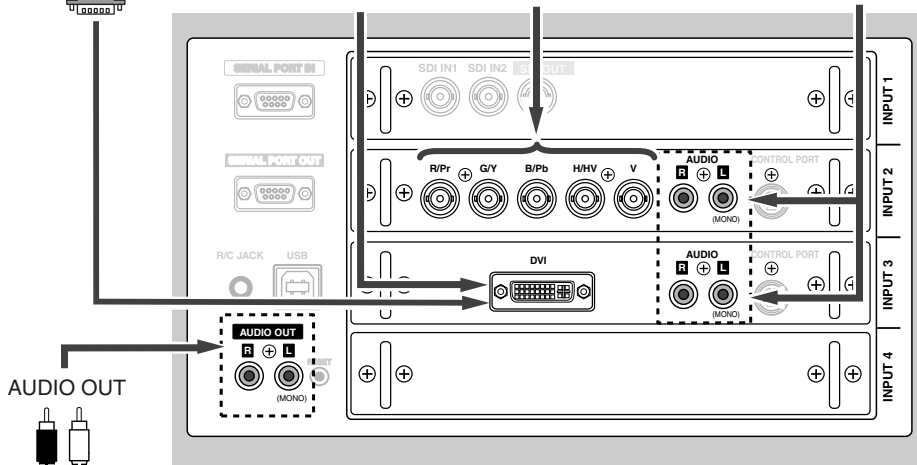
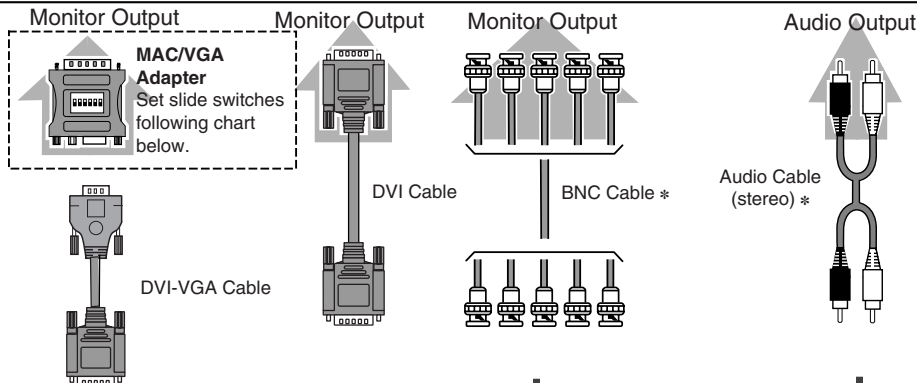
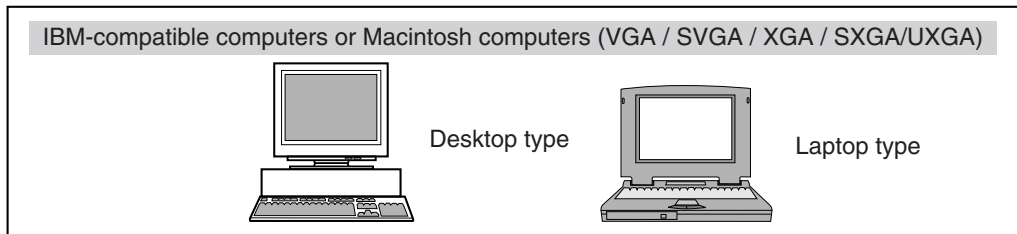

Terminals of a Projector

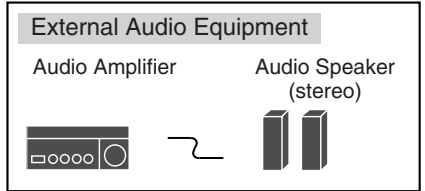
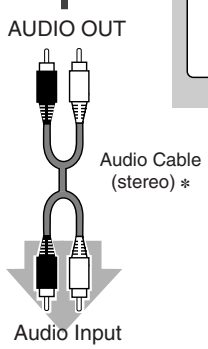

MAC/VGA ADAPTER

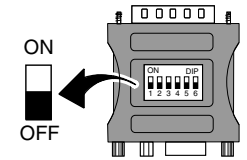

Switches of MAC/VGA Adapter

Set switches as shown in table below depending on RESOLUTION MODE that you want to use before your turn on a projector and computer

MODE \ SWITCHES	1	2	3	4	5	6
13"MODE (640 x 480)	ON	ON	OFF	OFF	OFF	OFF
16"MODE (832 x 624)	OFF	ON	OFF	ON	OFF	OFF
19"MODE (1024 x 768)	OFF	ON	ON	OFF	OFF	OFF
21"MODE (1152 x 870)	ON	ON	ON	ON	OFF	OFF

CONNECTING TO VIDEO EQUIPMENT

Cables used for connection

- Video Cable (BNC)*
- Audio Cable (RCA x 2) *
- Scart Cable *
- DVI-VGA Adapter *

(* = Cables are not supplied with this projector.)



NOTE :

When connecting cable, power cords of both a projector and external equipment should be disconnected from AC outlet. Turn a projector and peripheral equipment on before computer is switched on.

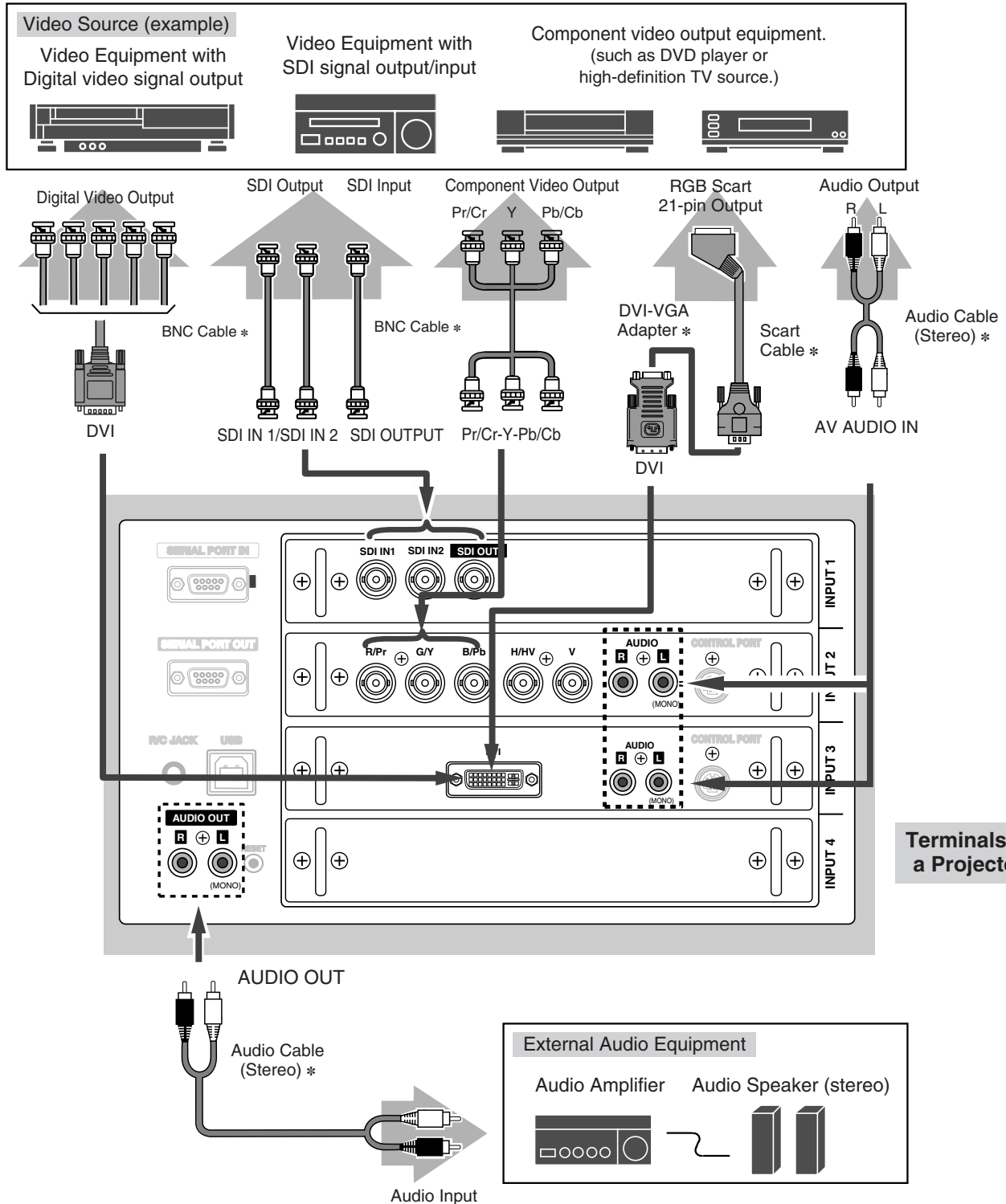

BEFORE OPERATION

SIDE CONTROLS AND INDICATORS

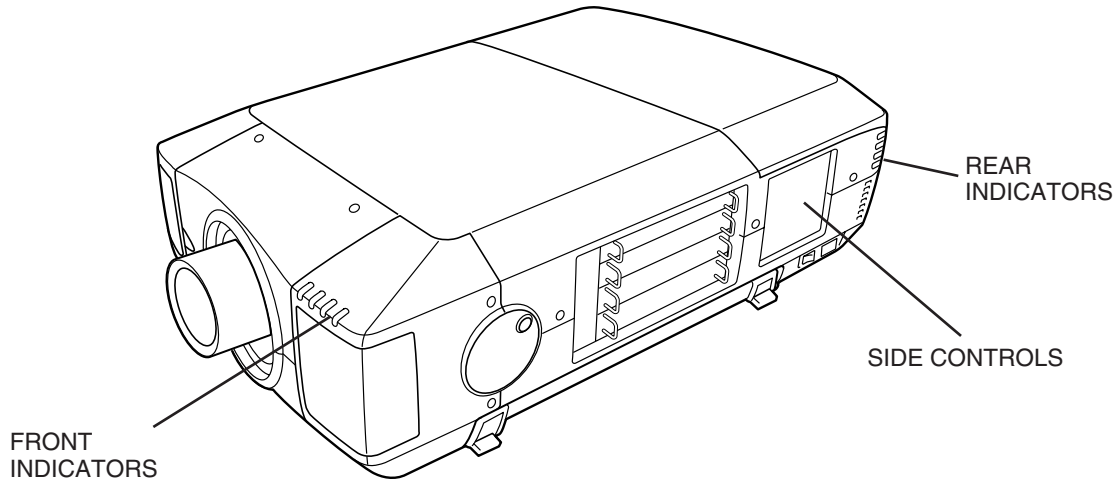

SIDE CONTROLS

ZOOM buttons
Adjust zoom. (P23)

FOCUS buttons
Adjust focus. (P23)

VOLUME buttons
Adjust volume. (P24)

POWER ON-OFF button
Turns the projector on or off. (P22)

MENU button
Open or close the On-Screen Menu operation. (P20, 21)

SELECT button
Executes the item selected. (P20)

AUTO PC ADJ. button
Operates the AUTO PC adjustment function. (P29)

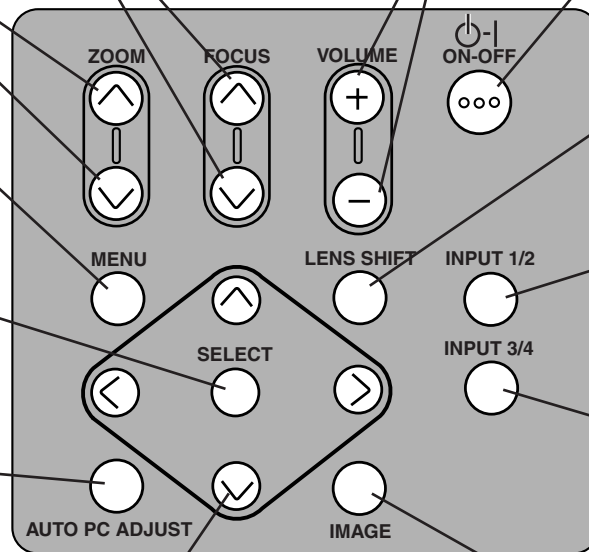

LENS SHIFT button
Select LENS SHIFT function. (P23)

INPUT 1/2 button
Select input source either INPUT 1 or INPUT 2. (P25)

INPUT 3/4 button
Select input source either INPUT 3 or INPUT 4. (P25)

POINT buttons
Selects an item or adjusts value in the On-Screen Menu. (P20)

IMAGE button
Selects image levels. (P32)

INDICATORS

FRONT INDICATORS

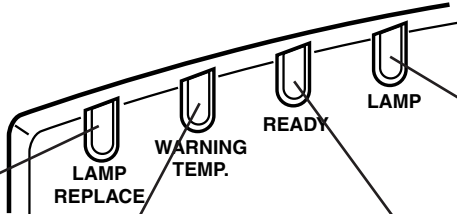

LAMP REPLACE indicator

This LAMP REPLACE indicator lights yellow when any of Projection Lamps is nearing its end, and flashes when any of them becomes out. Check which lamp needs to be replaced on Lamp Status Display. (P40-41)

WARNING TEMP. indicator

This indicator flashes red when internal projector temperature is too high. (P39)

READY indicator

This indicator lights green when a projector is ready to be turned on. And it flashes green in Power Management mode or internal projector temperature is to high. (P37, 39)

LAMP indicator

This indicator is dim when a projector is turned on. And bright when a projector is in stand-by mode.

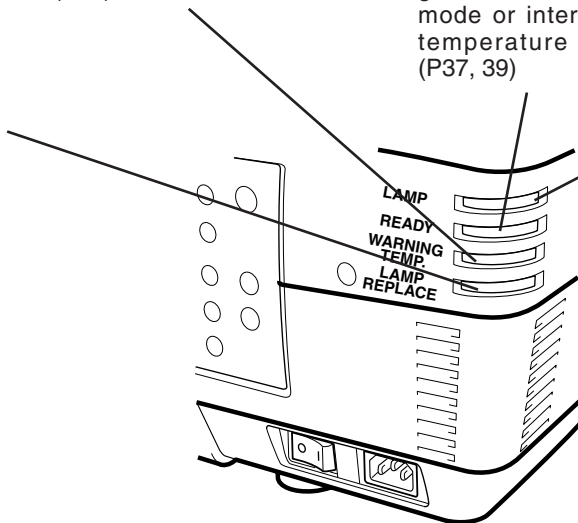

REAR INDICATORS

OPERATION OF REMOTE CONTROL

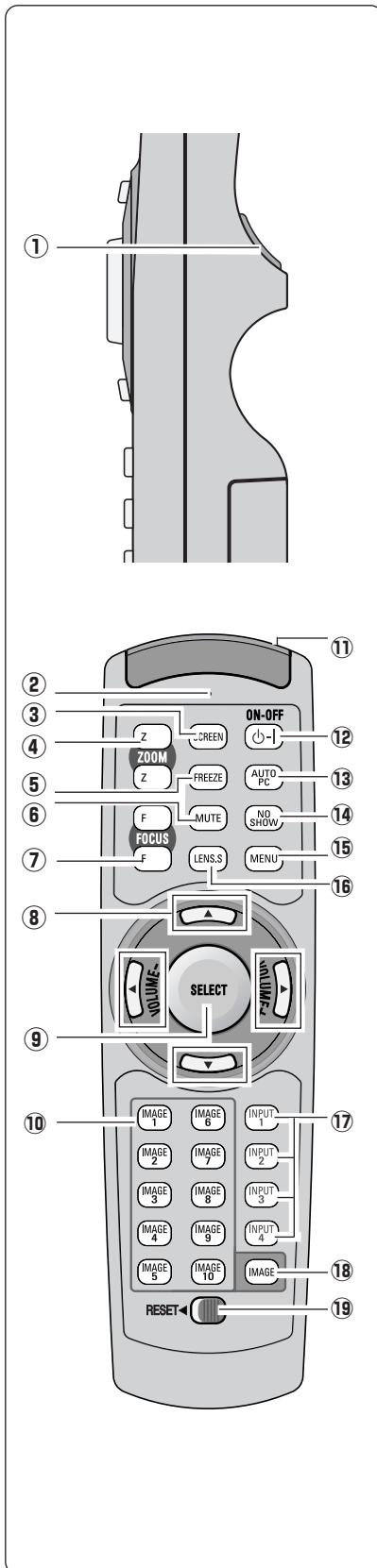

- ① **SELECT button**
Executes the item selected. (P20)
- ② **SIGNAL EMISSION indicator**
This indicator lights red while a signal is being sent from the remote control to the projector.
- ③ **SCREEN button**
Select image screen. (P28)
- ④ **ZOOM button**
Adjust zoom. (P23)
- ⑤ **FREEZE button**
Freezes the projected picture. (P23)
- ⑥ **MUTE button**
Mutes sound. (P24)
- ⑦ **FOCUS button**
Adjust focus. (P23)
- ⑧ **POINT (UP/DOWN/LEFT/RIGHT) button**
Selects an item or adjusts value in the On-Screen Menu. (P20)
Point Left/Right button are also used as VOLUME +/- button. (P24)
- ⑨ **SELECT button**
Executes the item selected. (P20)
- ⑩ **IMAGE (1-10) buttons**
Selects image levels (IMAGE 1 - IMAGE 10). (P32)
- ⑪ **WIRED REMOTE JACK**
When using as Wired Remote Control, connect Remote Control Cable to this jack.
Battery installation is required when using as Wired Remote Control.
- ⑫ **POWER ON-OFF button**
Turns the projector on or off. (P22)
- ⑬ **AUTO PC button**
Operates the Auto PC adjustment function. (P29)
- ⑭ **NO SHOW button**
Turns the picture into black image. (P23)
- ⑮ **MENU button**
Opens or closes the On-Screen Menu. (P20)
- ⑯ **LENS SHIFT button**
Select LENS SHIFT function. (P23)
- ⑰ **INPUT 1-4 buttons**
Select input source (INPUT 1-INPUT 4). (P25)
- ⑱ **IMAGE button**
Selects image levels. (P32)
- ⑲ **RESET switch**
Slide this switch to the "RESET" to initialize the remote control code. (P19, 37)

Remote Control Code Change and Operating Range

Code Change

This projector has eight different remote control codes (Code 1-Code 8); the factory-set, initial code (Code 1) and the other seven codes (Code 2 to Code 8). This switching function prevents remote control interference when operating several projectors or video equipment at the same time. (Change the remote control code for the projector first before changing that for the remote control. See "Remote control" on page 37.)

- 1 While pressing the MENU button, press the IMAGE button number of times corresponding to each remote control code number. Each time you press the IMAGE button, the code is changed sequentially. (See the list below.)
- 2 To initialize the remote control code for the remote control, slide the RESET switch to the RESET, and then to the ON. The initial code is Code 1.

Remote Control Code	Number of Times of Pressing IMAGE Button
Code 1	1
Code 2	2
Code 3	3
Code 4	4
Code 5	5
Code 6	6
Code 7	7
Code 8	8

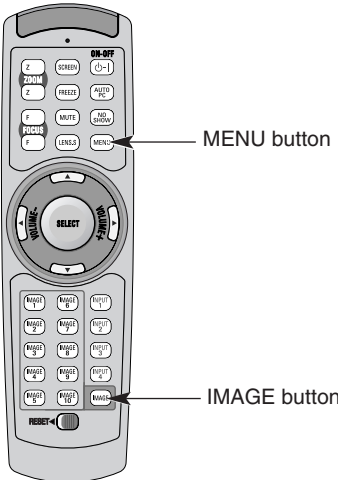

Operating Range

Point Remote Control Unit toward projector (Receiver Window) whenever pressing any button. Maximum operating range for Remote Control Unit is about 16.4' (5m) and 60° in front and rear of a projector.

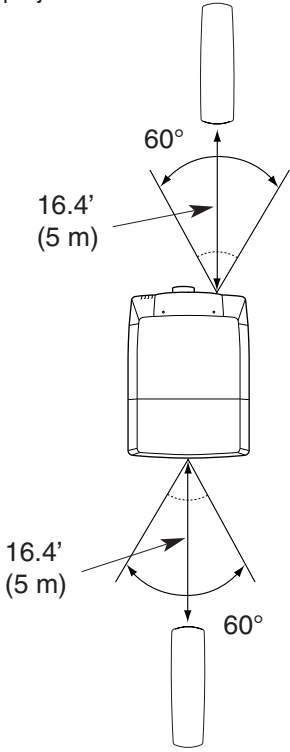

Remote Control Batteries Installation

- 1 Remove battery compartment lid. Press lid downward and slide it.
- 2 Slide batteries into compartment. **Two AA size batteries**
For correct polarity (+ and -), be sure battery terminals are in contact with pins in compartment.
- 3 Replace compartment lid.



To insure safe operation, please observe following precautions :

- Use (2) AA, UM3 or R06 type alkaline batteries.
- Replace two batteries at same time.
- Do not use a new battery with an used battery.
- Avoid contact with water or liquid.
- Do not expose Remote Control Unit to moisture, or heat.
- Do not drop Remote Control Unit.
- If a battery has leaked on Remote Control Unit, carefully wipe case clean and install new batteries.
- Danger of explosion if battery is incorrectly replaced.
- Dispose of used batteries according to the batteries manufacturers instructions and local rules.

OPERATING ON-SCREEN MENU

HOW TO OPERATE ON-SCREEN MENU

You can control and adjust this projector through ON-SCREEN MENU. Refer to following pages to operate each adjustment on ON-SCREEN MENU.

1 DISPLAY MENU

Press MENU button to display ON-SCREEN MENU.

2 MOVING POINTER

Move pointer (* see below) or adjust value of item by pressing POINT button(s) on Side Control or on Remote Control Unit.

* Pointer is a icon on ON-SCREEN MENU to select item. See figures on section "FLOW OF ON-SCREEN MENU OPERATION" below.

3 SELECT ITEM

Select item or set selected function by pressing SELECT button.

WIRELESS REMOTE CONTROL

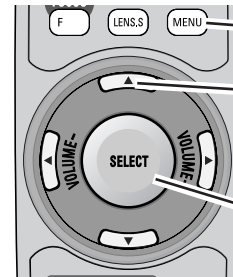

MENU BUTTON

POINT BUTTON
Used to move Pointer UP/ DOWN/ RIGHT/ LEFT.

SELECT BUTTON
Used to select item.

SIDE CONTROL

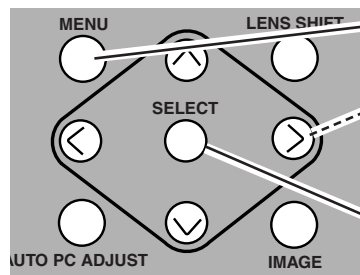

MENU BUTTON

POINT BUTTONS
Used to move Pointer UP/ DOWN/ RIGHT/ LEFT.

SELECT BUTTON
Used to select item.

FLOW OF ON-SCREEN MENU OPERATION

Display ON-SCREEN MENU

1 Press MENU button to display ON-SCREEN MENU (MENU BAR). A red frame is POINTER.

Select Menu to be adjusted

2 Move POINTER (red frame) to MENU ICON that you want to select by pressing POINT RIGHT / LEFT buttons.

Control or adjust item through ON-SCREEN MENU

3 Press POINT UP/DOWN button and move POINTER (red frame or red arrow) to ITEM that you want to adjust, and then press SELECT button to show ITEM DATA.

4 Adjust ITEM DATA by pressing POINT RIGHT / LEFT buttons. Refer to following pages for details of respective adjustments.

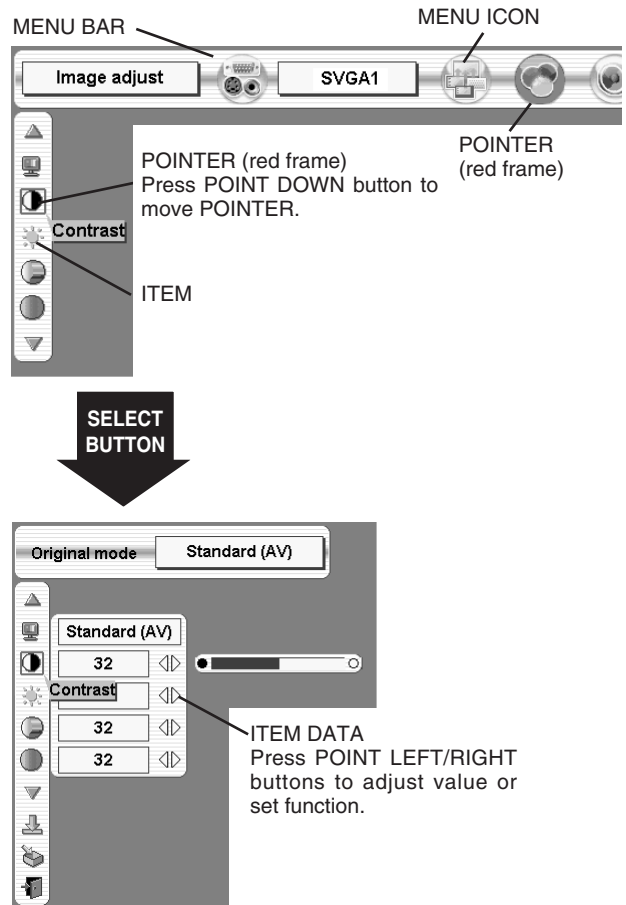

MENU BAR

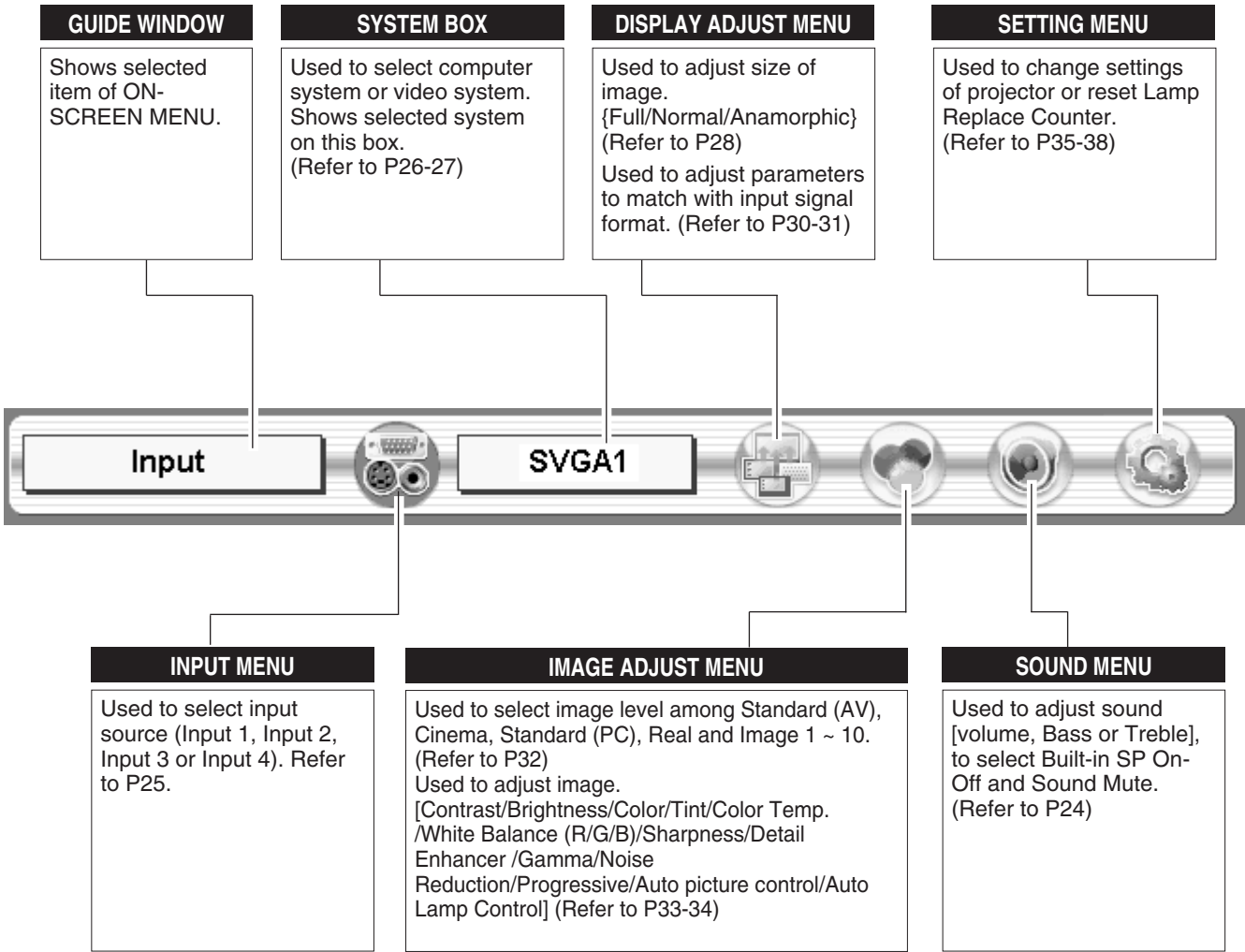

TURNING ON / OFF PROJECTOR

TURNING ON PROJECTOR

- 1 Complete peripheral connections (with Computer, VCR, etc.) before turning on projector. (Refer to "CONNECTING TO PROJECTOR" on Pages 12~15 for connecting that equipment.)
- 2 Connect a projector's AC Power Cord into a wall outlet and turn MAIN ON/OFF SWITCH to ON. LAMP indicator lights RED, and READY indicator lights GREEN.
- 3 Press POWER ON-OFF button on Side Control or on Remote Control Unit to ON. LAMP indicator dims, and Cooling Fans start to operate. Preparation Display appears on a screen and count-down starts. Signal from source appears after 30 seconds. Current Input and Lamp status are also displayed on screen for 5 seconds. (Refer to "LAMP MANAGEMENT" on page 40.)

INPUT AND LAMP STATUS

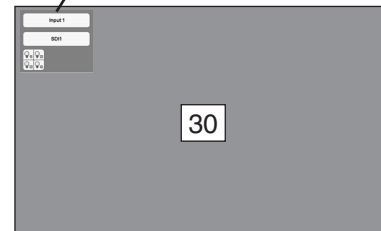

Preparation Display disappears after 30 seconds.

TURNING OFF PROJECTOR

- 1 Press POWER ON-OFF button on Side Control or on Remote Control Unit, and a message "Power off?" appears on a screen.
- 2 Press POWER ON-OFF button again to turn off projector. LAMP indicator lights bright and READY indicator turns off. After approximate 90 seconds, READY indicator will light green again and projector may be turned on by pressing POWER ON-OFF button.
- 3 Cooling fans will operate for approximate 2 minutes after projector is turned off. To power down completely, turn MAIN ON/OFF SWITCH to OFF and disconnect AC Power Cord.



Message disappears after 4 seconds.



TO MAINTAIN LIFE OF LAMP, ONCE YOU TURN PROJECTOR ON, WAIT AT LEAST 5 MINUTES BEFORE TURNING IT OFF.

When "Power Management" function mode is Ready or Shut down, projector detects signal interruption and turns off the Projection Lamp automatically. Refer to "Power management" on page 37.

When WARNING TEMP. Indicator is flashing, projector cannot be turned on, refer to the section "MAINTENANCE" on page 39. When the both WARNING TEMP. and READY Indicator flashing, refer to the section "MAINTENANCE" on page 39.



Do not use the projector continuously for 24 hours or more. If using the projector continuously for long periods, turn it off and leave it for one hour at least once during a 24 hour period. If you use the projector continuously for long period, it can excessively shorten the life of the lamp.

ADJUSTING SCREEN

ZOOM ADJUSTMENT

- 1 Press ZOOM ▲/▼ button on Side Control or on Remote Control Unit. Message “Zoom” is displayed.
- 2 Press ZOOM ▲ button to make image larger, and press ZOOM ▼ button to make image smaller.



Message disappears after 4 seconds.

FOCUS ADJUSTMENT

- 1 Press FOCUS ▲/▼ button on Side Control or on Remote Control Unit. Message “Focus” is displayed.
- 2 Adjust focus of image by pressing FOCUS ▲/▼ button(s).

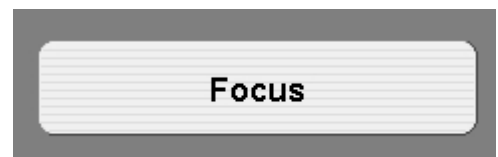

Message disappears after 4 seconds.

LENS SHIFT ADJUSTMENT

- 1 Press the LENS SHIFT button on Side Control or on the Remote Control Unit. Message “Lens shift” is displayed.
- 2 Press POINT UP button to move image up, press POINT DOWN button to move image down, press POINT LEFT to move image left and press POINT RIGHT to move image right.

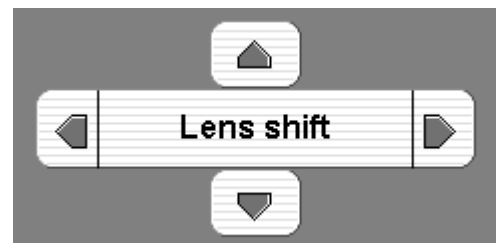

Message disappears after 4 seconds.

PICTURE FREEZE FUNCTION

Press FREEZE button on Remote Control Unit to freeze picture on-screen. To cancel FREEZE function, press FREEZE button again or press any other button.

NO SHOW FUNCTION

Press NO SHOW button on Remote Control Unit to black out image. To restore to normal, press NO SHOW button again or press any other button.

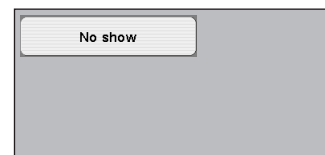

Message disappears after 4 seconds.

SOUND ADJUSTMENT

DIRECT OPERATION

Volume

Press VOLUME (+/-) button(s) on Side Control or on Remote Control Unit to adjust volume. Volume dialog box appears on screen for a few seconds.

(+) button to increase volume, and (-) button for decreasing.

Mute

Press MUTE button on Remote Control Unit to cut off sound. To restore sound to its previous level, press MUTE button again or press Volume (+/-) button(s).

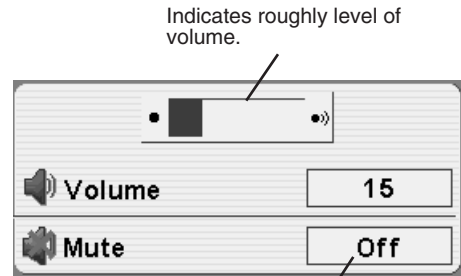

Display disappears after 4 seconds.

MENU OPERATION

1 Press MENU button and ON-SCREEN MENU will appear. Press POINT LEFT/RIGHT buttons to move a red frame pointer to SOUND Menu icon.

2 Press POINT DOWN button to move a red frame pointer to item that you want to select, and then press SELECT button.



Volume

To increase volume, press POINT RIGHT button, and press POINT LEFT button for decreasing.



Treble

To adjust Treble sound, press POINT RIGHT button or POINT LEFT button.



Bass

To adjust Bass sound, press POINT RIGHT button or POINT LEFT button.



Built-in SP.

Press POINT LEFT/RIGHT button(s) to switch built-in speaker on and off.



Mute

Press POINT LEFT/RIGHT button(s) to cut off sound. Dialog box display is changed to "On" and sound is cut off. To restore sound to its previous level, press POINT LEFT/RIGHT button(s) again.



Quit

Closes SOUND MENU.

SOUND MENU

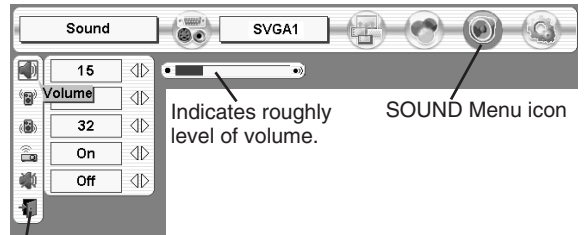

Close SOUND Menu.

SELECTING INPUT SOURCE

DIRECT OPERATION

Select INPUT source by pressing INPUT 1/2 and INPUT 3/4 buttons on Side Control or INPUT 1, INPUT 2, INPUT 3 and INPUT 4 on Remote Control Unit.

MENU OPERATION

- 1 Press MENU button and ON-SCREEN MENU will appear. Press POINT LEFT/RIGHT buttons to select Input and press SELECT button. Another dialog box INPUT SELECT Menu will appear.
- 2 Press POINT DOWN button and a red-arrow icon will appear. Move arrow to INPUT source that you want to select, and then press SELECT button.

INPUT 1/2 button

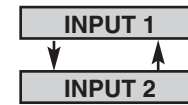

INPUT 3/4 button

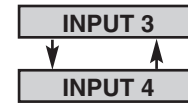

INPUT 1-4 buttons

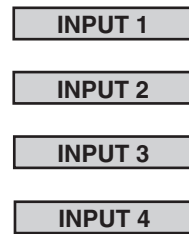

INPUT MENU

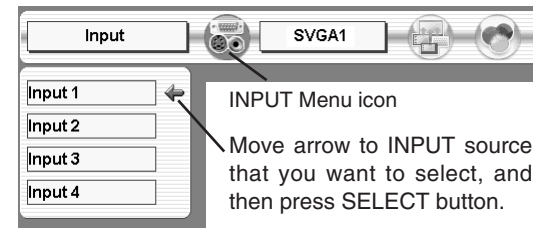

WHEN SELECT INPUT 1 (SDI TERMINAL)

Move a pointer to either SDI 1 or SDI 2 and press SELECT button.

WHEN SELECT INPUT 2 (5 BNC TERMINAL)

Move a pointer to source that you want to select and press SELECT button.

RGB

When connect a computer output [5 BNC Type (Red, Green, Blue, Horiz. Sync and Vert. Sync.)] from a computer to R/Pr, G/Y, B/Pb, H/HV and V jacks.

Y, Pb/Cb, Pr/Cr

When connect component video output (Cr, Y, Cb or Pr, Y, Pb) from video equipment to R/Pr, G/Y and B/Pb jacks.

WHEN SELECT INPUT 3 (DVI TERMINAL)

Move a pointer to source that you want to select and press SELECT button.

RGB(Analog)

When your computer is connected to INPUT 3 (ANALOG) terminal, select RGB(Analog).

RGB(Scart)

When video equipment is connected to INPUT 3 (ANALOG) terminal, select RGB(Scart).

RGB(PC Digital)

When your computer is connected to INPUT 3 (DIGITAL) terminal, select RGB(PC Digital).

RGB(AV HDCP)

If a HDCP-compatible signal source is connected to the INPUT 3 (DIGITAL) terminal, select RGB(AV HDCP).

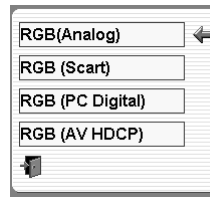
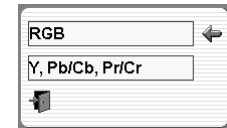
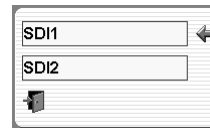

NOTE;
HDCP (High-bandwidth Digital Content Protection) is a system for protecting digital entertainment content which is delivered by DVI (Digital Visual Interface) from being copied. The specification of HDCP is decided and controlled by Digital Content Protection, LLC. Should the specification be changed, this projector may not display the digital content protected by HDCP.

SYSTEM SELECT

AUTOMATIC MULTI-SCAN SYSTEM

This projector automatically tunes to most different types of computers based on VGA, SVGA, XGA, SXGA or UXGA (refer to "COMPATIBLE COMPUTER SPECIFICATION" on pages 50-51). When a computer is selected, this projector automatically tunes to incoming signal and projects the proper image without any special setting. (Some computers need to be set manually.)

The projector displays one of the Auto, -----, Mode 1 ~ Mode 20, or the system provided in the projector.

Auto When projector cannot recognize connected signal as PC system provided in this projector, Auto PC Adjustment function operates to adjust projector and message "Auto" is displayed on SYSTEM Menu icon. When image is not provided properly, manual adjustment is required. (Refer to P30 and 31.)

----- There is no signal input from computer. Make sure connection of computer and a projector is set correctly. (Refer to TROUBLESHOOTING on page 43.)

Mode 1 User preset adjustment in MANUAL PC ADJUSTMENT. Adjustment data can be stored in the Mode 1-20.

SVGA 1 Computer systems provided in the projector. The projector chooses proper system and displays it.

* Mode 1 and SVGA 1 are examples.

SELECT COMPUTER SYSTEM MANUALLY

This projector automatically selects PC system among those provided in this projector and PC system can be also selected manually.

- 1 Press MENU button and ON-SCREEN MENU will appear. Press POINT LEFT/RIGHT buttons to move a red frame pointer to SYSTEM SELECT Menu icon.
- 2 Press POINT UP/DOWN button to move a red arrow pointer to system that you want to set, and then press SELECT button.

SYSTEM MENU

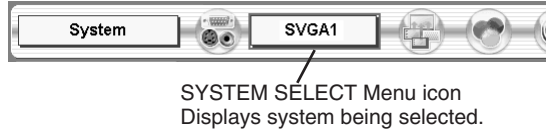

SYSTEM SELECT MENU (PC)

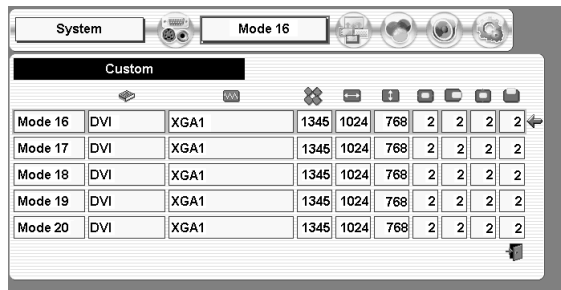
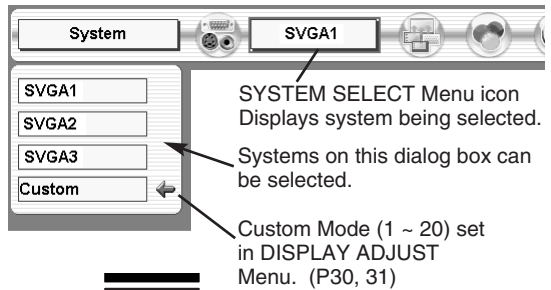

SELECT VIDEO SYSTEM

- 1 Press MENU button and ON-SCREEN MENU will appear. Press POINT LEFT/RIGHT buttons to move a red frame pointer to SYSTEM SELECT Menu icon.
- 2 Press POINT DOWN button to move a red arrow pointer to system that you want to select and then press SELECT button.

SDI Input

Projector automatically detects incoming SDI signal (480i, 575i, 1035i, 1080i/60, 1080i/50, 720p, 1080p/30 and 1080psf/30), and adjusts itself to optimize its performance.

When System is 1080i/60 or 1080psf/30, select system manually first.

Component video (Y, Pb/Cb, Pr/Cr) Input

Auto

Projector automatically detects incoming Video signal, and adjusts itself to optimize its performance.

When Video System is 1035i, 1080i/50 or 1080i/60, select system manually first.

COMPONENT VIDEO SIGNAL FORMAT

If projector cannot reproduce proper video image, it is necessary to select a specific component video signal format among 480i, 575i, 480p, 575p, 720p, 1035i, 1080i/50 or 1080i/60.

SYSTEM SELECT MENU (SDI)

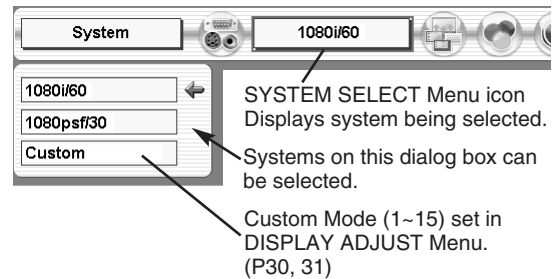

SYSTEM SELECT MENU (Component video)

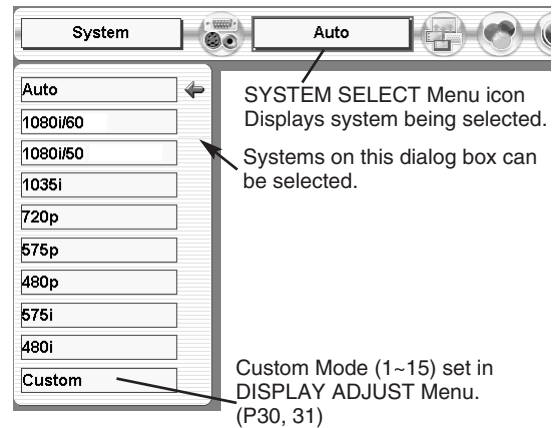

DISPLAY ADJUSTMENTS

SCREEN ADJUSTMENTS

This projector has a picture screen resize function, which enables you to display desirable image size.

- 1 Press MENU button and ON-SCREEN MENU will appear. Press POINT LEFT/RIGHT button(s) to move a red frame pointer to DISPLAY ADJUST Menu icon.
- 2 Press POINT UP/DOWN button and move a red frame pointer to Screen and then press SELECT button.
- 3 Press POINT UP/DOWN button to move a red arrow to level that you want to set and then press SELECT button.

Full

Provides image to fit the horizontal size of the screen size.

Normal

Provides image in its original size.

Anamorphic

Provides image is forcibly changed to a 4:3 image, even if the input signal is HDTV.

SCREEN ADJUSTMENT (DIRECT)

Select screen by pressing Screen button on Remote Control Unit.

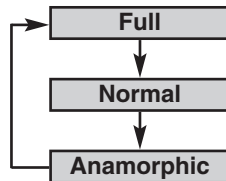

Aspect H



Aspect V

These adjust the horizontal and vertical scale and position of the screen. When a SELECT button is pressed, the mode changes to Scale or Position adjustment mode. Use the POINT LEFT/RIGHT button(s) to select whether you wish to adjust Scale or Position, and then use the POINT UP/DOWN button(s) to adjust the values.

DISPLAY ADJUST MENU

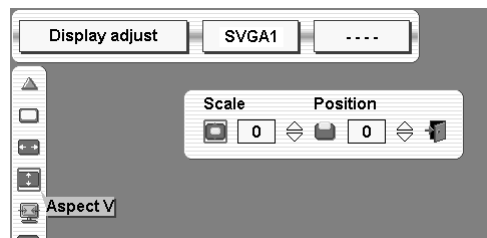
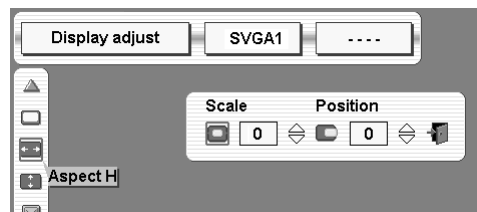
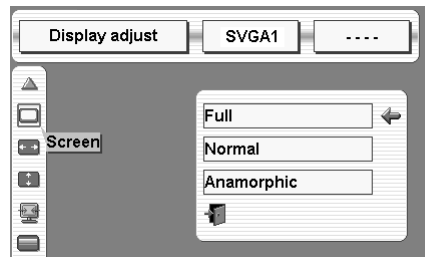
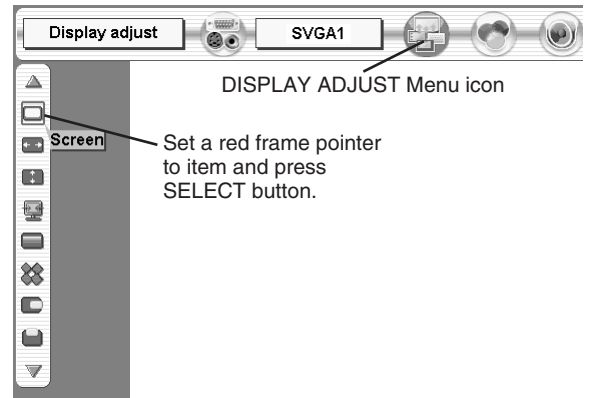

AUTO PC ADJUSTMENT

Auto PC Adjustment function is provided to automatically adjust Fine sync, Total dots and Picture Position to conform to your computer. Auto PC Adjustment function can be operated as follows.



Auto PC Adj.

- 1 Press MENU button and ON-SCREEN MENU will appear. Press POINT LEFT/RIGHT button to move a red frame pointer to DISPLAY ADJUST Menu icon.
- 2 Press POINT DOWN button to move a red frame pointer to AUTO PC Adj. icon and then press SELECT button twice. This Auto PC Adjustment can be also executed by pressing AUTO PC ADJ. button on Side Control or on Remote Control Unit.

Store adjustment parameters.

Adjustment parameters from Auto PC Adjustment can be memorized in this projector. Once parameters are memorized, setting can be done just by selecting Mode in SYSTEM SELECT Menu (P26). Refer to step 3 of MANUAL DISPLAY ADJUSTMENT section (P31).

NOTE

- Fine sync, Total dots and Picture Position of some computers can not be fully adjusted with this Auto PC Adjustment function. When image is not provided properly through this function, manual adjustments are required. (Refer to page 30, 31.)
- Auto PC Adjustment function cannot be operated in Digital Signal input on DVI terminal and "480i", "575i", "480p", "575p", "720p (HDTV)", "1035i (HDTV)", "1080i/50 (HDTV)" or "1080i/60 (HDTV)" is selected on SYSTEM SELECT Menu (P26).

DISPLAY ADJUST MENU

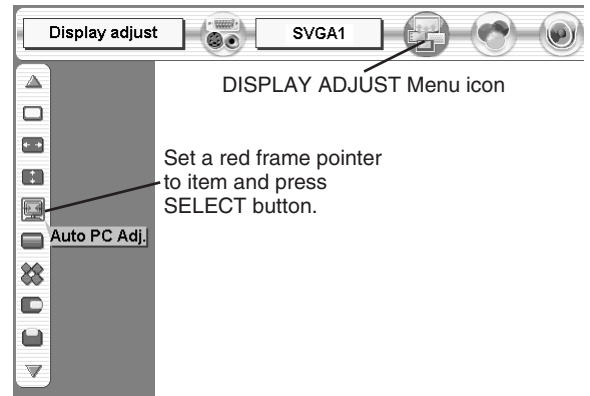

MANUAL DISPLAY ADJUSTMENTS

This projector can automatically tune to display signals from most computers and video equipments currently distributed. However, some computers and video equipments employ special signal formats which are different from standard ones and may not be tuned by Multi-Scan system of this projector. If this happens, projector cannot reproduce a proper image and image may be recognized as a flickering picture, a non-synchronized picture, a non-centered picture or a skewed picture. This projector has a Manual display adjustment to enable you to precisely adjust several parameters to match with those special signal formats.

This projector has 20 independent memory areas {Mode 1~15 for video equipments and computers (digital signal), Mode 16 ~ 20 for computers (analog signal)} to memorize those parameters manually adjusted. This enables you to recall setting for a specific computer and video equipment whenever you use it.

1 Press MENU button and ON-SCREEN MENU will appear. Press POINT LEFT/RIGHT button to move a red frame pointer to PC ADJUST Menu icon.

2 Press POINT UP/DOWN button to move a red frame pointer to item that you want to adjust and then press SELECT button. Adjustment dialog box will appear. Press POINT LEFT/RIGHT button to adjust value.



Fine sync

Adjusts an image as necessary to eliminate flicker from display. Press POINT LEFT/RIGHT button to adjust value. (From 0 to 31.)



Total dots

Adjust the number of total dots in one horizontal period. Press POINT LEFT/RIGHT button(s) and adjust number to match your PC image.



Horizontal

Adjusts horizontal picture position. Press POINT LEFT/RIGHT button(s) to adjust position.



Vertical

Adjusts vertical picture position. Press POINT LEFT/RIGHT button(s) to adjust position.

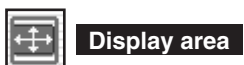

Display area

Selects area displayed with this projector. Select resolution at Display area dialog box.



Display area H

Adjustment of horizontal area displayed with this projector. Press POINT LEFT/RIGHT button(s) to decrease/increase value and then press SELECT button.



Display area V

Adjustment of vertical area displayed with this projector. Press POINT LEFT/RIGHT button(s) to decrease/increase value and then press SELECT button.

DISPLAY ADJUST MENU

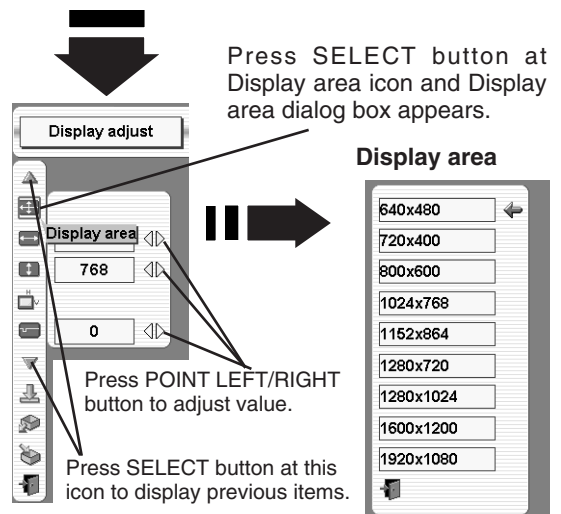
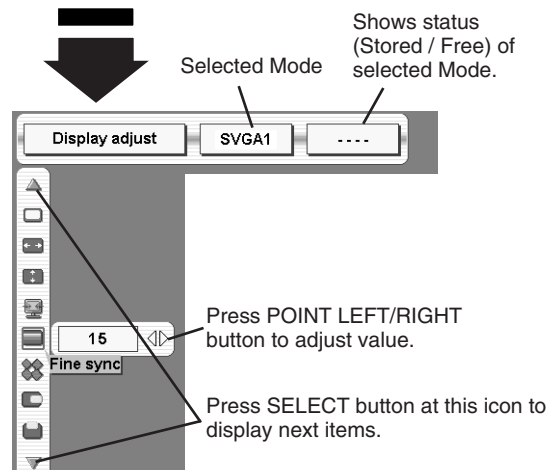
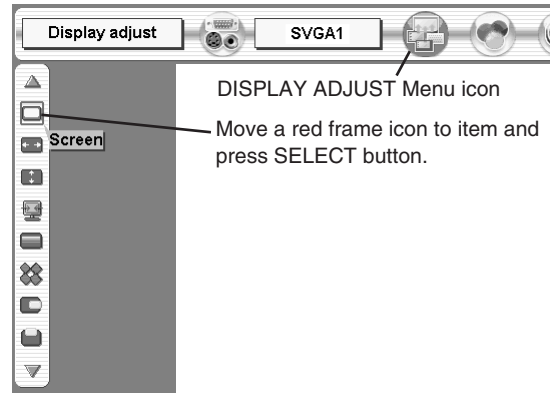



Current mode

Press SELECT button to show information of computer selected.



Clamp

Adjusts clamp position. When image has a dark bar(s), try this adjustment.

3



Store

To store adjustment parameters, move a red frame pointer to Store icon and then press SELECT button. Move a red arrow pointer to any of Mode 1 to 20 that you want to store and then press SELECT button.



Mode free

To clear adjustment parameters previously set, move a red frame pointer to Mode free icon and then SELECT button. Move a red arrow pointer to Mode that you want to clear and then press SELECT button.

Other icons operates as follows.



Reset

Reset all adjust parameters on adjustment dialog box to previous figure.



Quit

Closes DISPLAY ADJUST MENU.

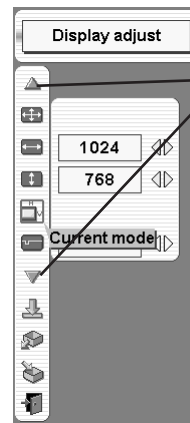

Press SELECT button at this icon to display previous items.

Current mode

H-Sync freq.	48.5
V-Sync freq.	60.0

Press SELECT button at Current mode icon to show information of computer connected.

To store adjustment data.

Terminal board and System of input signal. Shows values of "Total dots" "Display area H" and "Display area V".

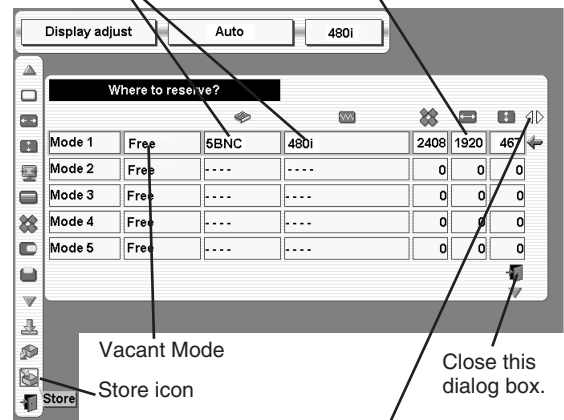

Vacant Mode

Store icon

Close this dialog box.

Press POINT LEFT/RIGHT buttons to display right page.

To clear adjustment data.

Shows values of scale and position of "Aspect H" and "Aspect V".

This Mode has parameters being stored.

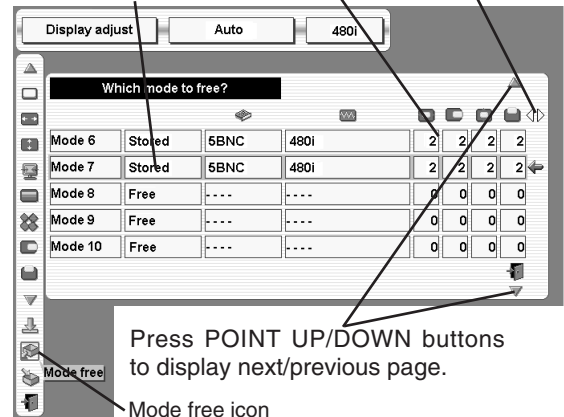

Press POINT UP/DOWN buttons to display next/previous page.

Mode free icon

IMAGE ADJUSTMENTS

IMAGE LEVEL SELECT (DIRECT)

Select image level among Standard (AV), Cinema, Standard (PC), Real and Image 1 ~ Image 10 by pressing IMAGE button on Side Control or on Remote Control Unit.
 Select image level Image 1 ~ Image 10 by pressing IMAGE 1 ~ IMAGE 10 buttons on Remote Control Unit.

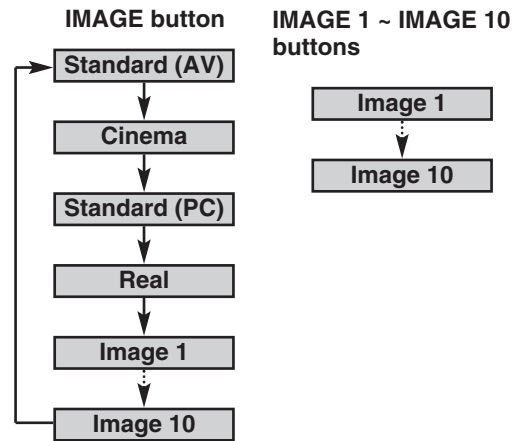

Standard (AV)

Normal picture level preset on this projector for AV mode.

Cinema

Picture level adjusted for picture with fine tone.

Standard (PC)

Normal picture level preset on this projector for PC mode.

Real

Picture level with improved halftone for graphics.

IMAGE 1~10

User preset picture adjustment in IMAGE ADJUST Menu (P33, 34).

IMAGE LEVEL SELECT (MENU)

- 1 Press MENU button and ON-SCREEN MENU will appear. Press POINT LEFT/RIGHT button to move a red frame pointer to IMAGE ADJUST Menu icon.
- 2 Press POINT UP/DOWN button to move a red frame pointer to image icon and then press SELECT button.
- 3 Press POINT UP/DOWN button to move a red arrow to level that you want to set and then press SELECT button.

IMAGE ADJUST MENU

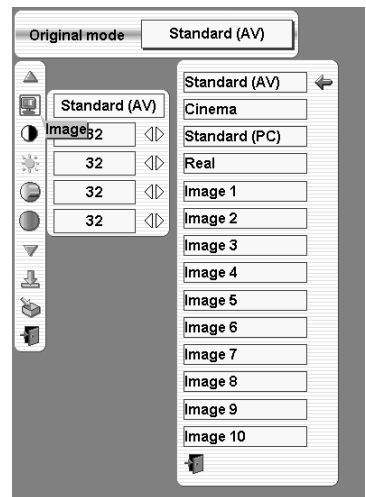
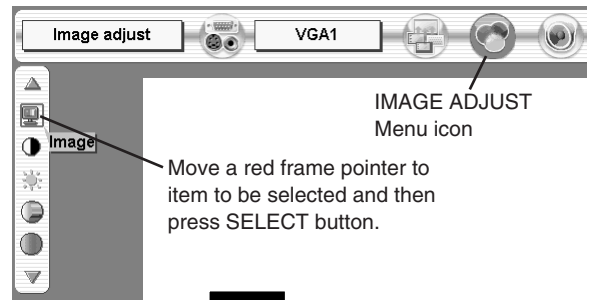

Standard (AV)

Normal picture level preset on this projector for AV mode.

Cinema

Picture level adjusted for picture with fine tone.

Standard (PC)

Normal picture level preset on this projector for PC mode.

Real

Picture level with improved halftone for graphics.

IMAGE 1~10

User preset picture adjustment in IMAGE ADJUST Menu (P33, 34).

IMAGE LEVEL ADJUSTMENTS

- 1 Press MENU button and ON-SCREEN MENU will appear. Press POINT LEFT/RIGHT buttons to move a red frame pointer to IMAGE ADJUST Menu icon.
- 2 Press POINT UP/DOWN button to move a red frame pointer to item that you want to adjust and then press SELECT button. Level of each item is displayed. Adjust each level by pressing POINT LEFT/RIGHT button(s).



Contrast

Press POINT LEFT button to decrease contrast, and POINT RIGHT button to increase contrast. (From 0 to 63.)



Brightness

Press POINT LEFT button to adjust image darker, and POINT RIGHT button to adjust brighter. (From 0 to 63.)



Color

Press POINT LEFT button to lighten color, and POINT RIGHT button to deeper color. (From 0 to 63.)



Tint

Press POINT LEFT button or POINT RIGHT button to obtain proper color. (From 0 to 63.)



Color temp.

Press either POINT LEFT button or POINT RIGHT button to Color temp. level that you want to select. (XLow, Low, Mid or High)



White balance (Red)

Press POINT LEFT button to lighten red tone and POINT RIGHT button to deeper tone. (From 0 to 63.)



White balance (Green)

Press POINT LEFT button to lighten green tone and POINT RIGHT button to deeper tone. (From 0 to 63.)



White balance (Blue)

Press POINT LEFT button to lighten blue tone and POINT RIGHT button to deeper tone. (From 0 to 63.)



Sharpness

Press POINT LEFT button to soften the image, and POINT RIGHT button to sharpen the image. (From 0 to 15.)



Detail enhancer

Press either POINT LEFT button or POINT RIGHT button to enhance the detail of the image. (From 0 to 15.)



Gamma

Press either POINT LEFT button or POINT RIGHT button to obtain better balance of contrast. (From 0 to 15.)

IMAGE ADJUST MENU

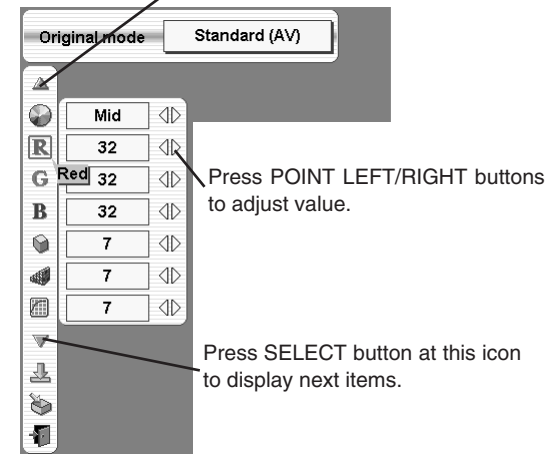
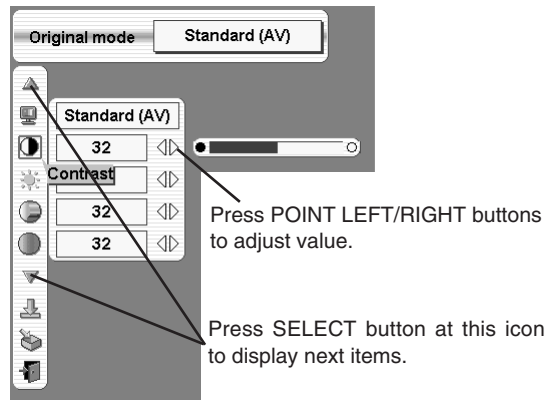
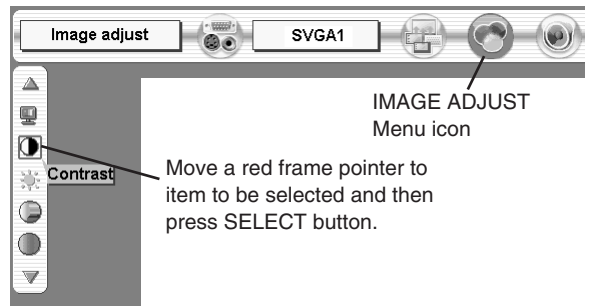

DISPLAY ADJUST



Noise reduction

Press POINT LEFT/RIGHT button(s) to change noise reduction mode. Dialog box display is changed to "Off", "L1", "L2" or "L3" to reduce noise (rough parts) of image.

Off Noise reduction OFF position.

L1 Noise reduction LEVEL 1 position.

L2 Noise reduction LEVEL 2 position.

L3 Noise reduction LEVEL 3 position.



Progressive scan

Press POINT LEFT/RIGHT button(s) to change progressive scan mode. Dialog box display is changed to "Off" and progressive scan mode to off. Press POINT LEFT/RIGHT button(s) again, progressive scan mode to on.



Auto picture control

Press either POINT LEFT button or POINT RIGHT button to Auto picture control position that you want to select . (Off, L1 or L2)

Off Auto picture control OFF position.

L1 Auto picture control LEVEL 1 position.

L2 Auto picture control LEVEL 2 position.



Lamp mode

The projector reduce the brightness and set into the low power consumption mode. When this function is "On", the brightness is adjusted automatically to a level that is suitable for the screen.



Store

To store manually preset image, move a red frame pointer to Store icon and press SELECT button. Image Level Menu will appear. Move a red frame pointer to Image 1 to 10 where you want to set and then press SELECT button. Message "OK?" is displayed. Move pointer to [Yes] and then press SELECT button.

Other icons operates as follows.



Reset

Reset all adjustment to previous figure.



Quit

Closes IMAGE MENU.

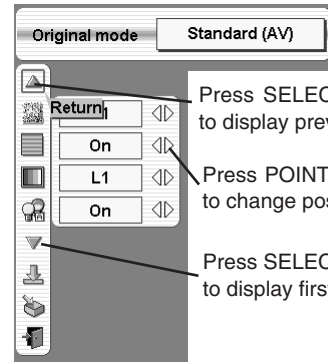

Press SELECT button at this icon to display previous items.

Press POINT LEFT/RIGHT buttons to change position.

Press SELECT button at this icon to display first items.

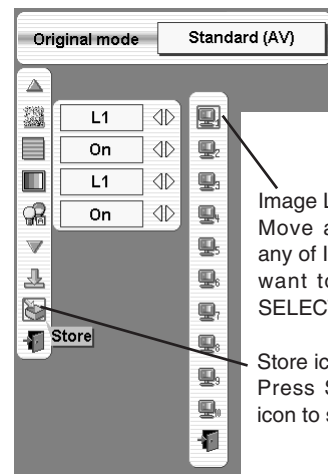
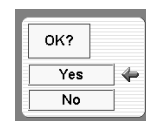

Image Level Menu
Move a red frame pointer to any of Image 1 to 10 where you want to set and then press SELECT button.

Store icon
Press SELECT button at this icon to store the adjustment.



SETTING MENU

- 1 Press MENU button and ON-SCREEN MENU will appear. Press POINT LEFT/RIGHT button(s) to move a red-frame pointer to SETTING icon.
- 2 Press POINT DOWN button to move a red-frame pointer to item that you want to set and then press SELECT button. Setting dialog box appears.



Language

Language used in ON-SCREEN MENU is selectable from among English, German, French, Italian, Spanish, Portuguese, Dutch, Swedish, Russian, Chinese, Korean and Japanese.



Lamp Mode

This Projector is equipped with 4 Projection Lamps and a number of using lamps can be switched to 4 lamps or 2 lamps. Using 2 lamps maintain life of Projection Lamps.

To change over Lamp Mode

1. Press MENU button and ON-SCREEN MENU will appear. Press POINT LEFT/RIGHT buttons to select SETTING and press SELECT button. Setting dialog box appears.
2. Press POINT DOWN button to move a red frame pointer to "Lamp mode". Set "4 lamps mode" or "2 lamps mode" by pressing POINT LEFT/RIGHT button(s). When Lamp Mode is set from "4 lamps mode" to "2 lamps mode" image becomes little darker. When Lamp Mode is set from "2 lamps mode" to "4 lamps mode" image become brighter gradually.



Blue back

When this function is "On," this projector will produce a blue image instead of the video noise on the screen when any input source is unplugged or turned off.



Display

This function decides whether to display On-Screen Displays.

- On ... shows all the On-Screen Displays.
 Off ... sets On-Screen Displays disappeared except;
- ON-SCREEN MENU
 - "Power off?" message
 - P-TIMER
 - "No signal" message
 - "Wait a moment" message



Menu size

This function decides to display On-Screen Displays size.

- Normal ... shows normal size the On-Screen Displays.
 Double ... shows double size the On-Screen Displays.

SETTING MENU

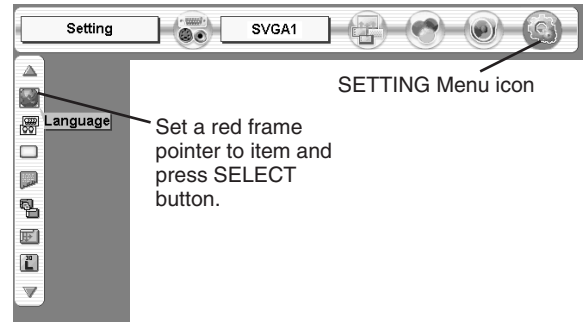

When pressing SELECT button at Language, Language Menu appears.

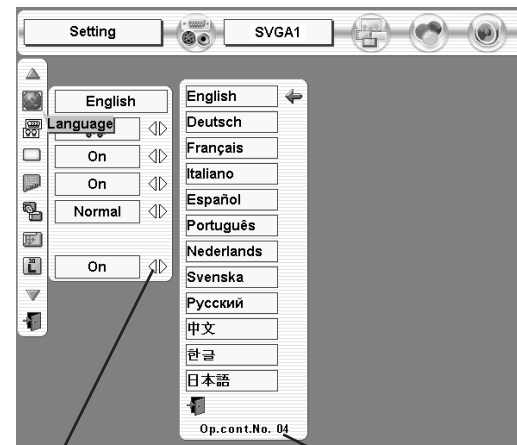

Move a pointer to item and then press POINT LEFT/RIGHT button(s).

Optional Control Number Refer to page 11.



Menu position

This function is used to adjust the on-screen menu display position. When a SELECT button is pressed, the adjustment screen is displayed (arrows appear). Use the POINT UP/DOWN/LEFT/RIGHT button(s) to adjust the position. After making the adjustment, press a SELECT button to return to the Menu screen.



Logo

When this function is "On," projector displays logo when starting up.



Ceiling

When this function is "On," picture is top / bottom and left / right reversed. This function is used to project the image from a ceiling mounting the projector.

Ceiling function

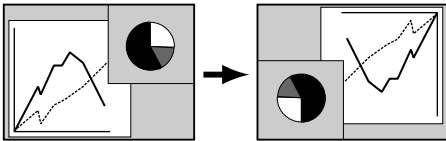

Rear

When this function is "On," picture is left / right reversed. This function is used to project the image to a rear projection screen.

Rear function

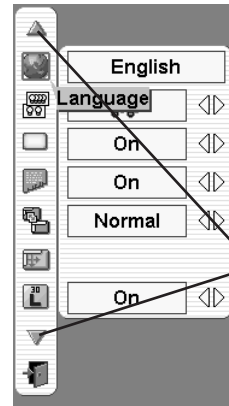
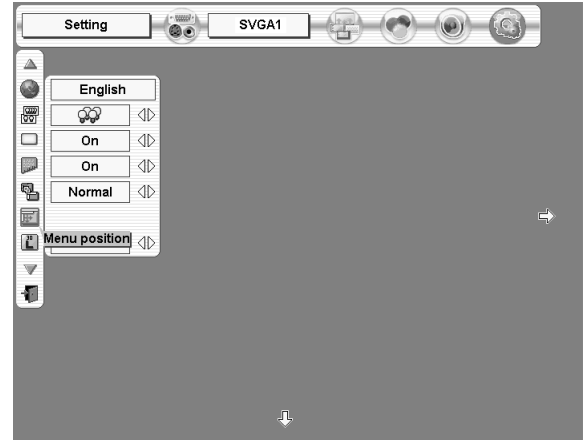
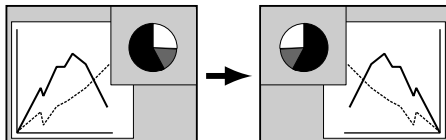

Press SELECT button at this icon to display next items.

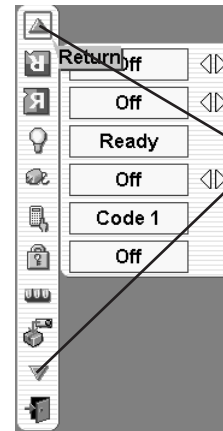

Press SELECT button at this icon to display previous items.



Power management

This projector is equipped with a power management function. When the input signal is interrupted and any button is not pressed for 30 seconds or more, the power management function operates in order to reduce power consumption and conserve lamp operating time. The factory default settings for power management are "Ready" and "5 Min".

OPERATION

- 1) If the input signal is interrupted and any button is not pressed for 30 seconds or more, the message "No signal" and the timer display appears on the screen. Then the count-down starts for the time being set.

If "Ready" is selected

- 2) When the set time is elapsed, the lamp will be switched off and lamp cooling starts. The READY indicator will be switched off while the lamp cooling is in progress, and the projector cannot be operated during this time.
- 3) When the lamp cooling is completed, the READY indicator starts flashing to notify the operator that power management mode is active. In this condition, the lamp will turn on and images will be projected if a signal starts being input or the projector is operated.

If "Shut down" is selected

- 2) When the set time is elapsed, the lamp will be switched off and lamp cooling starts. The READY indicator will be switched off while the lamp cooling is in progress, and the projector cannot be operated during this time.
- 3) When the lamp cooling is completed, the power switches off.

If "Off" is selected

The power management function is canceled.

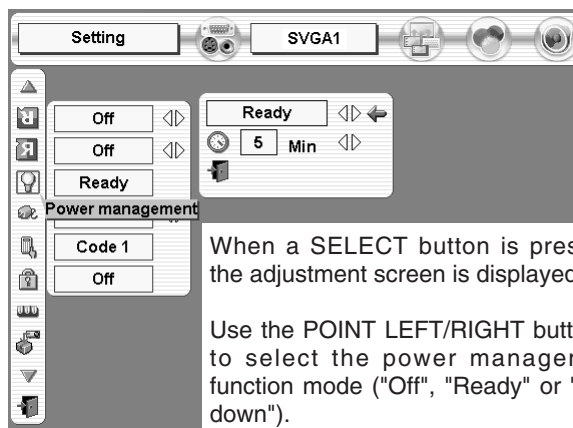

When a SELECT button is pressed, the adjustment screen is displayed.

Use the POINT LEFT/RIGHT button(s) to select the power management function mode ("Off", "Ready" or "Shut down").



Use the POINT DOWN button to move the pointer to the time setting, and then use the POINT LEFT/RIGHT button(s) to set the time (1 minute to 30 minutes).

Time left until Lamp off.



On start

When this function is "On," projector is automatically turned on just by connecting AC Power cord to a wall outlet.

Note ; Be sure to turn projector off properly (refer to section "TURNING OFF PROJECTOR" on P22). If projector is turned off in wrong steps, On Start function does not operate properly.



Remote control

This projector has eight different remote control codes; the factory-set normal code (Code 1) and the other seven codes (Code 2 to Code 8). This switching function prevents remote control operation mixture (jam) when operating several projectors or video equipment together.

For example operating projector in "Code 7," both projector and Remote Control Unit must be switched to "Code 7."

To change the code of Projector;

To change the Remote control code of the projector used in ON-SCREEN MENU is selectable from Code 1 to Code 8.

To change the code of the Remote Control Unit;

While pressing the MENU button, press the IMAGE button number of times corresponding to each remote control code number. (Refer to P18.)

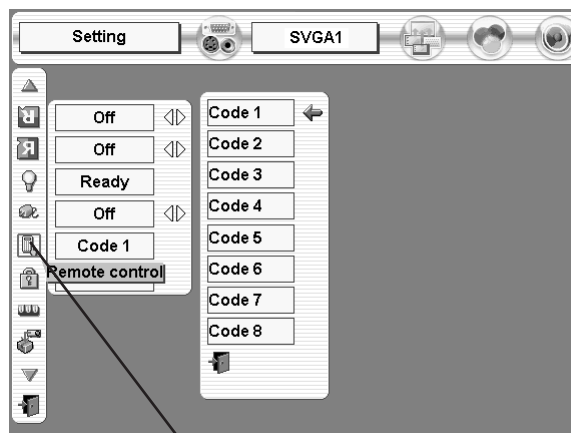

When pressing SELECT button at Remote control, Remote control code Menu appears.

SETTING



Key lock

This function locks the operation of the projector's control panel and the remote control.

This locks operation of the projector's control panel.

This locks operation of the remote control.

Off This cancels the Key lock function.

If the projector's control panel accidentally becomes locked and you do not have the remote control nearby, turn the MAIN ON/OFF switch to OFF. And then while pressing a SELECT button, return the MAIN ON/OFF switch to ON again. This will cancel the projector's control panel lock.

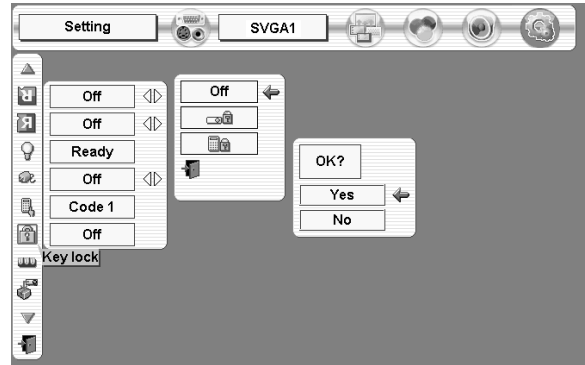

Lamp counter reset

Be sure to reset Lamp Counter when Lamp Assembly is replaced. When Lamp Replace Counter is reset, LAMP REPLACE indicator stops lighting.

1 Turn projector on, press MENU button and ON-SCREEN MENU will appear. Press POINT LEFT/RIGHT button(s) to move a red frame pointer to SETTING Menu icon.

2 Press POINT DOWN button to move a red frame pointer to "Lamp counter reset" and then press SELECT button.

3 Move arrow to replaced lamp number (Lamp 1, Lamp 2, Lamp 3 or Lamp 4) and then press SELECT button. Message "Lamp replace counter Reset?" is displayed. Move pointer to [Yes] and then press SELECT button.

NOTE: Be sure to reset correct lamp number otherwise LAMP REPLACE indicator continues lighting.

4 Another confirmation dialog box appears and select [Yes] to reset Lamp Replace Counter.

Do not reset Lamp Replace Counter except after Projection lamp is replaced.

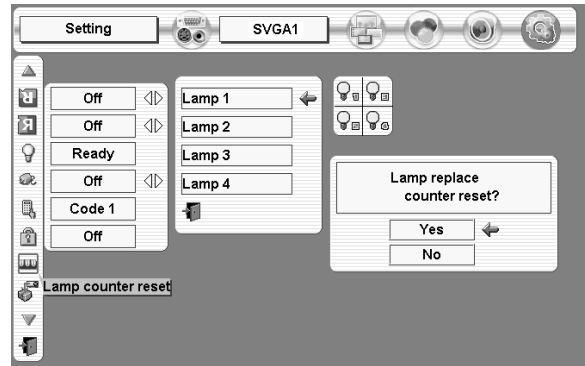

Factory default

This function returns all setting values except for the lamp counter to the factory default settings.

Press POINT UP/DOWN button to move a red frame pointer to "Factory default" and then press SELECT button. The message "Return to Factory default?" is displayed. Move the pointer to [Yes] and then press SELECT button.

Another confirmation dialog box appears and select [Yes] and then press SELECT button. Return the projector to Factory default.

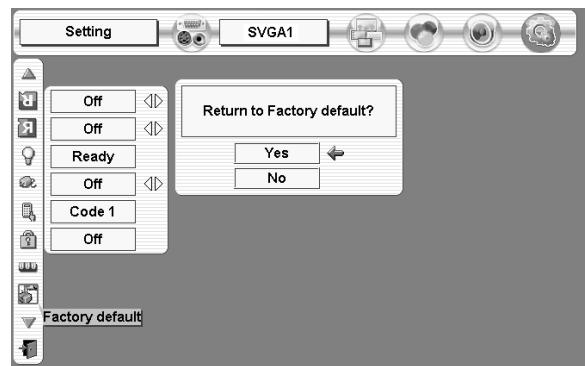

Quit

Closes SETTING MENU.

MAINTENANCE

WARNING TEMP. INDICATOR

The Warning Temp. Indicator flashes red to let you know the internal temperature of the projector exceeds the normal level. If the temperature goes up further, the projector will be turned off automatically and the Ready indicator will go out. (The Warning Temp. Indicator continues flashing.) After the cooling-off period, the Ready Indicator lights on again and the projector can be turned on by pressing the On/Off button on the remote control unit or on the side control. When you turn on the projector, the Warning Temp. Indicator will go out.

If the Warning Temp. Indicator is still flashing, check the followings;

- 1 Ventilation Slots of a projector may be blocked. In such an event, reposition a projector so that Ventilation Slots are not obstructed.
- 2 Air Filter may be clogged with dust particles. Clean Air Filter by following section AIR FILTER CARE AND CLEANING on this page.
- 3 If WARNING TEMP. Indicator remains on after performing above checks, Cooling Fans or Internal Circuits may be malfunctioning. Contact the service station.

FRONT INDICATORS

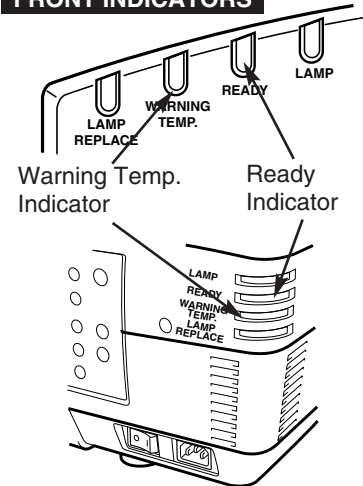

When both of the Warning Temp. and Ready indicators are flashing:

REAR INDICATORS

When the projector detects an internal problem, it will shut down automatically and both of the Warning temp. and Ready Indicators starts flashing. In this condition, the projector cannot be turned on even if you press the On/Off button on the remote control unit or on the side control. If this case happens, disconnect and reconnect the AC power cord, and then turn on the projector again to check its operation. If the projector shuts down again or fails to be turned on, the internal check and repair will be required. Plug off the AC power cord and contact service station.

AIR FILTER CARE AND CLEANING

Air Filter prevents dust from accumulating on surface of Projection Lens and Projection Mirror. Should Air Filter become clogged with dust particles, it will reduce Cooling Fans' effectiveness and may result in internal heat build up and adversely affect life of a projector. Clean Air Filter following steps below:

- 1 Turn power off, and disconnect AC power cord from AC outlet.
- 2 Pull out air filter from a projector.
- 3 Pulling up center frame of air filter top, separate air filter top and sheet from air filter base.
- 4 Clean each parts with brush or wash out dust and particles. Be sure to dry them out.
- 5 Assemble sheet and air filter and replace air filter to a projector.

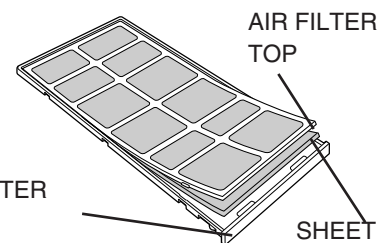
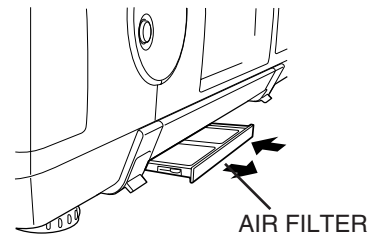

CAUTION

Do not operate a projector with Air Filter removed. Dust may accumulate on LCD Panel and Mirror degrading picture quality.
Do not put small parts into Air Intake Vents. It may result in malfunction of a projector.

RECOMMENDATION

We recommend avoiding dusty/smoky environments when operating a projector. Usage in these environments may cause poor image quality.

When using under dusty or smoky conditions, dust may accumulate on liquid crystal panel, lens, or optical elements inside it. This condition may degrade quality of projected image.

When above symptoms are noticed, contact your authorized dealer or service station for proper cleaning.

LAMP MANAGEMENT

This Projector is equipped with 4 Projection Lamps to ensure brighter image and those lamps are controlled by Lamp Management Function. Lamp Management Function detects status of all lamps and shows status on screen or on LAMP REPLACE indicator. This function also automatically controls Lamp Mode when any of lamps is out for end of life or malfunctions.

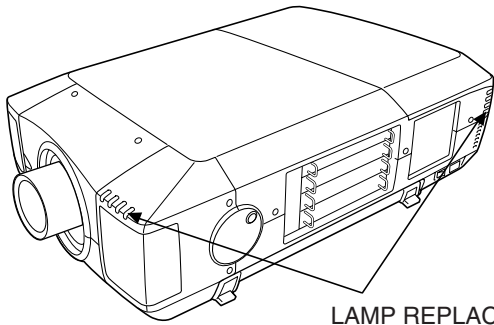

LAMP REPLACE INDICATOR

INPUT AND LAMP STATUS

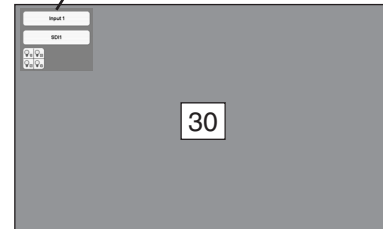

Lamp Replace Indicator

This LAMP REPLACE indicator lights yellow when any of Projection Lamps is nearing its end, and flashes when any of them becomes out. Check number of lamp on Lamp Status Display and replace lamp.

Lamp Status Display

Lamp Status Display appears on screen when power switch is on or changed input position (input 1, input 2, Input 3 or input 4). This shows status of each lamp as; ON, OFF, NEAR END, or OUT. Refer to following for each status.

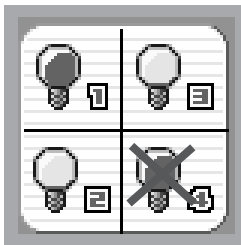

LAMP STATUS DISPLAY

Yellow Lamp ----- Projection Lamp lights normally.

Dim Lamp ----- Projection Lamp is turned off.

Red Lamp ----- Projection Lamp is nearing its end. When image becomes darker or color becomes unnatural, replace lamp. (LAMP REPLACE indicator lights yellow.)

X Mark on Lamp ----- (LAMP REPLACE indicator flashes yellow.)
Projection lamp is defective or fails to be turned on. Restart a projector on, and make sure lamp is on. If this mark still appears, replace lamp corresponding with number marked X.

Lamp Mode Changeover

Lamp Management Function automatically changes combination of lighting lamp (Lamp Mode) by detecting status of lamp. When any of 4 lamps becomes out, Lamp Mode is changed over from 4 lamps to 2 lamps. And when any of 2 lamps are out, a projector operates with 1 lamp. Lamp Mode can be switched to 4 lamps or 2 lamps manually. Refer to SETTING section on page 35.

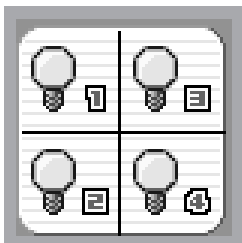

4 LAMP MODE

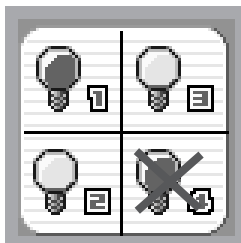

2 LAMP MODE
(Example)

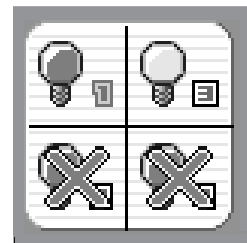

1 LAMP MODE
(Example)

LAMP REPLACEMENT

When the life of the Projection Lamp of this projector draws to an end, the LAMP REPLACE indicator lights yellow. If this indicator lights yellow, replace the projection lamp with a new one promptly.

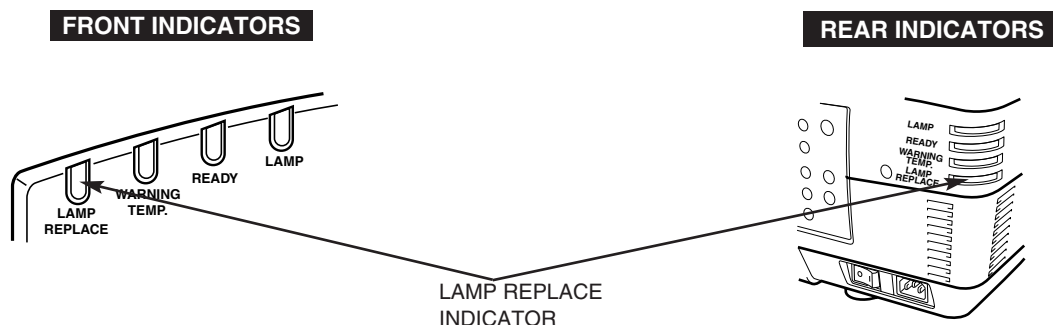

Allow a projector to cool, for at least 45 minutes before you open Lamp Cover. The inside of a projector can become very hot.



CAUTION

For continued safety, replace with a lamp assembly of the same type.

Do not drop a lamp assembly or touch a glass bulb! The glass can shatter and may cause injury.

Follow these steps to replace lamp assembly.

- 1 Check number of lamp to be replaced on Lamp Status Display.
- 2 Turn off a projector and disconnect AC Power Cord. Allow a projector to cool down for at least 45 minutes.
- 3 Remove two screws on Lamp Cover and press button to open Lamp Cover. (See right figure.)
- 4 Loosen two screws and pull out Lamp Assembly to be replaced by grasping handle.
- 5 Replace Lamp Assembly with a new one and tighten two screws. Make sure Lamp is set properly
- 6 Replace Lamp Cover and tighten two screws.
- 7 Connect AC Power Cord to a projector and turn a projector on.
- 8 Reset Lamp Replacement Counter. (Refer to section "Lamp Counter Reset" on page 38.)

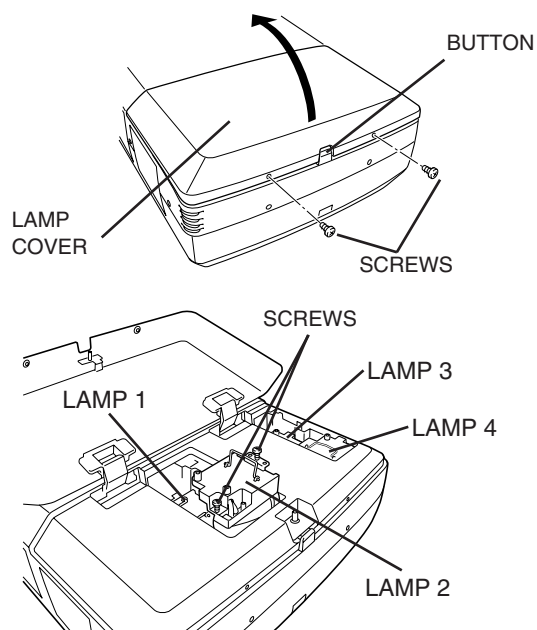

Make sure which number of lamp needs to be replaced on Lamp Status Display. Figure shows case of replacing LAMP 2.

NOTE : Do not reset LAMP REPLACEMENT COUNTER when lamp is not replaced.

CAUTION : DO NOT OPERATE A PROJECTOR WHILE ANY OF LAMPS IS REMOVED. IT MAY RESULT IN MALFUNCTIONS, FIRE HAZARD, OR OTHER ACCIDENTS.

NOTES ON LAMP REPLACEMENT

To maintain quality of picture (better balance of color and brightness in entire screen), we recommend replacing all 4 lamps at a time.

ORDER REPLACEMENT LAMP

Replacement Lamp can be ordered through your dealer. When ordering a Projection Lamp, give the following information to the dealer.

- **Model No. of your projector** : **PLV-HD10**
- **Replacement Lamp Type No.** : **POA-LMP72**
(Service Parts No. 610 305 1130)



LAMP HANDLING PRECAUTIONS

This projector uses a high-pressure lamp which must be handled carefully and properly. Improper handling may result in accidents, injury, or create a fire hazard.

- Lamp lifetime may differ from lamp to lamp and according to the environment of use. There is no guarantee of the same lifetime for each lamp. Some lamps may fail or terminate their lifetime in a shorter period of time than other similar lamps.
- If the projector indicates that the lamp should be replaced, i.e., if the LAMP REPLACE INDICATOR lights up, replace the lamp with a new one IMMEDIATELY after the projector has cooled down. (Follow carefully the instructions in the LAMP REPLACEMENT section of this manual.) Continuous use of the lamp with the LAMP REPLACE INDICATOR lighted may increase the risk of lamp explosion.
- A Lamp may explode as a result of vibration, shock or degradation as a result of hours of use as its lifetime draws to an end. Risk of explosion may differ according to the environment or conditions in which the projector and lamp are being used.

IF A LAMP EXPLODES, THE FOLLOWING SAFETY PRECAUTIONS SHOULD BE TAKEN.

If a lamp explodes, disconnect the projector's AC plug from the AC outlet immediately. Contact an authorized service station for a checkup of the unit and replacement of the lamp. Additionally, check carefully to ensure that there are no broken shards or pieces of glass around the projector or coming out from the cooling air circulation holes. Any broken shards found should be cleaned up carefully. No one should check the inside of the projector except those who are authorized trained technicians and who are familiar with projector service. Inappropriate attempts to service the unit by anyone, especially those who are not appropriately trained to do so, may result in an accident or injury caused by pieces of broken glass.

CLEANING PROJECTION LENS

Follow these steps to clean projection lens:

- 1** Apply a non-abrasive camera lens cleaner to a soft, dry cleaning cloth. Avoid using an excessive amount of cleaner. Abrasive cleaners, solvents or other harsh chemicals might scratch lens.
- 2** Lightly wipe cleaning cloth over lens.
- 3** When a projector is not in use, replace lens cover.

TROUBLESHOOTING

Before calling your dealer or service center for assistance, check matters below once again.

1. Make sure you have connected a projector to your computer or video equipment as described in section "CONNECTING PROJECTOR" on pages 12 ~ 15.
2. Check cable connection. Verify that all computer, video and power cord are properly connected.
3. Verify that all power is switched on.
4. If a projector still does not produce an image, re-start your computer.
5. If an image still does not appear, unplug a projector from your computer and check your computer monitor's display. Problem may be with your graphics controller rather than with a projector. (When you reconnect a projector, be sure to turn a computer and monitor off before you power up a projector. Power equipment back on in order of : Projector and computer.)
6. If problem still exists, check following chart.

Problem:	Try these Solutions
No power.	<ul style="list-style-type: none"> ● Plug a projector into your AC outlet. ● Turn MAIN ON/OFF switch to ON. ● Press POWER ON/OFF switch to ON. ● Make sure READY Indicator lights. ● Wait 90 seconds after a projector is turned OFF when turning a projector back on. <p>NOTE : After pressing Power ON-OFF button to OFF, make sure a projector works as follows:</p> <ol style="list-style-type: none"> 1. LAMP indicator lights bright and READY indicator turns off. 2. After 90 seconds, READY indicator lights green again and a projector may be turned on by pressing Power ON-OFF button. <ul style="list-style-type: none"> ● Check WARNING TEMP. and READY indicator. If both WARNING TEMP. and READY indicator flashes, a projector cannot be turned on. (See "TURNING ON/OFF PROJECTOR" section on page 22.) ● Check Projection Lamp. (Refer to page 41.)
Image is out of focus.	<ul style="list-style-type: none"> ● Adjust focus of a projector. ● Check Projection Lens to see if it needs cleaning. <p>NOTE : Moving a projector from a cool temperature location to a warm temperature location may result in moisture condensation on Projection Lens. In such an event, leave a projector OFF and wait until condensation disappears.</p>
Picture is Left/Right reversed.	<ul style="list-style-type: none"> ● Check Ceiling / Rear feature. (See "SETTING" section on page 36.)
Picture is Top/Bottom reversed.	<ul style="list-style-type: none"> ● Check Ceiling feature. (See "SETTING" section on page 36.)
Some displays are not seen during Operation.	<ul style="list-style-type: none"> ● Check Display feature. (See "SETTING" section on page 35.)
No image.	<ul style="list-style-type: none"> ● Check connection between your computer or video equipment and a projector. ● When turning a projector on, it takes about 30 seconds to display an image. ● Check system that you select is corresponding with your computer or video equipment. ● Make sure temperature is not out of Operating Temperature (5°C ~ 35°C).
No sound.	<ul style="list-style-type: none"> ● Check audio cable connection from audio input source. ● Adjust audio source. ● Press VOLUME (+) button. ● Press MUTE button.

Problem:	Try these Solution
Remote Control Unit does not work.	<ul style="list-style-type: none">● Check batteries.● Make sure nothing is between Infrared Remote Receiver and Remote Control Unit.● Make sure you are not too far from a projector when using Remote Control Unit. Maximum operating range is 16.4' (5m).● Check transmitted signal mode from Remote Control Unit. (See "SETTING" section on page 37.)

SERVICE

WARNING: High voltages are used to operate this projector. Do not attempt to open cabinet.

You can often correct operating problems yourself. If a projector fails to work properly, see "TROUBLESHOOTING" section on pages 43-44. To correct failure, try "Solutions".

If after following all operating instructions, you find that service is necessary, contact Sanyo Service Station or store where you purchased unit.

Give model number and explain difficulty. We will advise you how to obtain service.



This symbol on the nameplate means the product is Listed by Underwriters Laboratories Inc. It is designed and manufactured to meet rigid U.L. safety standards against risk of fire, casualty and electrical hazards.



The CE Mark is a Directive conformity mark of the European Community (EC).

INDICATORS AND PROJECTOR CONDITION

Check the Indicators for projector condition.

Indicators				Projector Condition
LAMP REPLACE yellow	WARNING TEMP. red	READY green	LAMP red	
				The projector is OFF. (The MAIN switch OFF position or the AC Power Cord is unplugged.)
※				The projector is READY to be turned on with the POWER ON-OFF button.
※				The projector is operating normally.
※				The temperature inside the projector is abnormally high. The projector cannot be turned on. When the projector is cooled down enough and the temperature returns to normal, the READY indicator lights green and the projector can be turned on. (The WARNING TEMP. indicator keeps flashing.) Check and clean the Air Filter.
※				The projector is cooled down enough and the temperature returns to normal. When turning on the projector, the WARNING TEMP. indicator stops flashing. Check and clean the Air Filter.
※				The projector is being cooled down. It cannot be turned on until the READY indicator lights green.
※				The projector detects an abnormal condition and cannot be turned on. Unplug the AC Power Cord and plug it again to turn on the projector. If the projector is turned off again, disconnect the AC Power Cord and contact the dealer or the service center for service and checkup. Do not leave the projector on. It may cause electric shock or a fire hazard.
※				The projector is in the Power management mode.

... on : red
 ... flashing : red
 ... on : green
 ... flashing : green
 ... dim
 ... off

* When the life of the projection lamp draws to an end, the LAMP REPLACE indicator lights yellow. When this indicator lights yellow, replace the projection lamp with a new one promptly. Reset the Lamp Replace Counter after replacement of the lamp.

MENU TREE

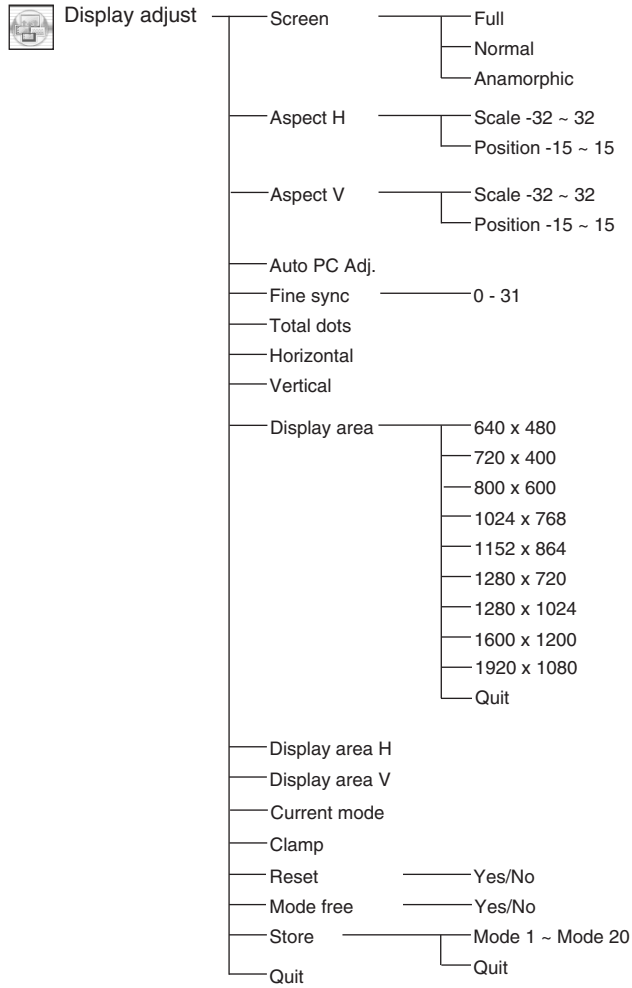
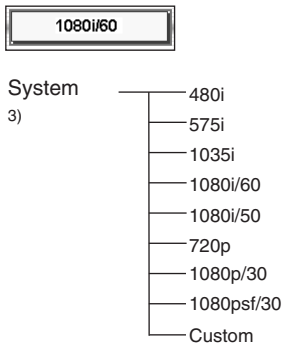
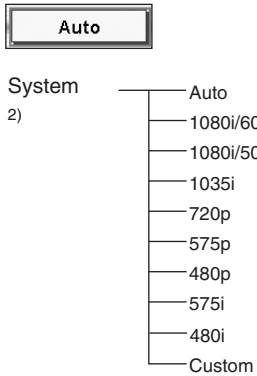
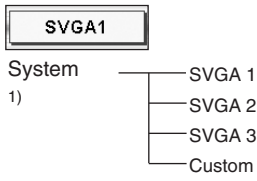
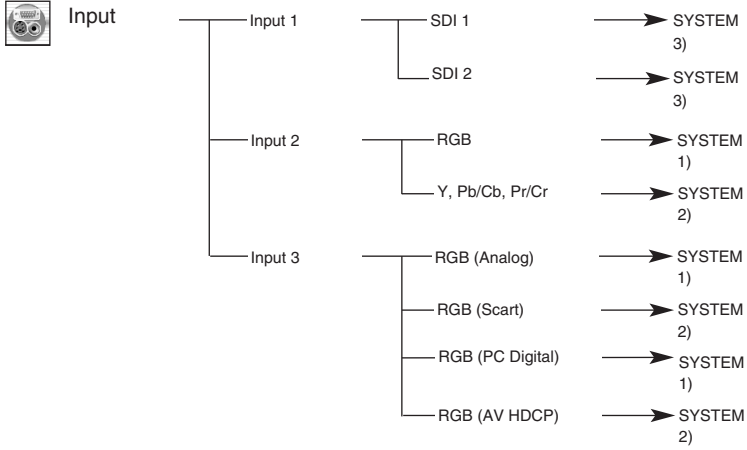

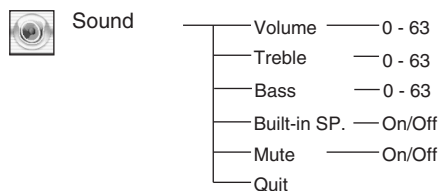
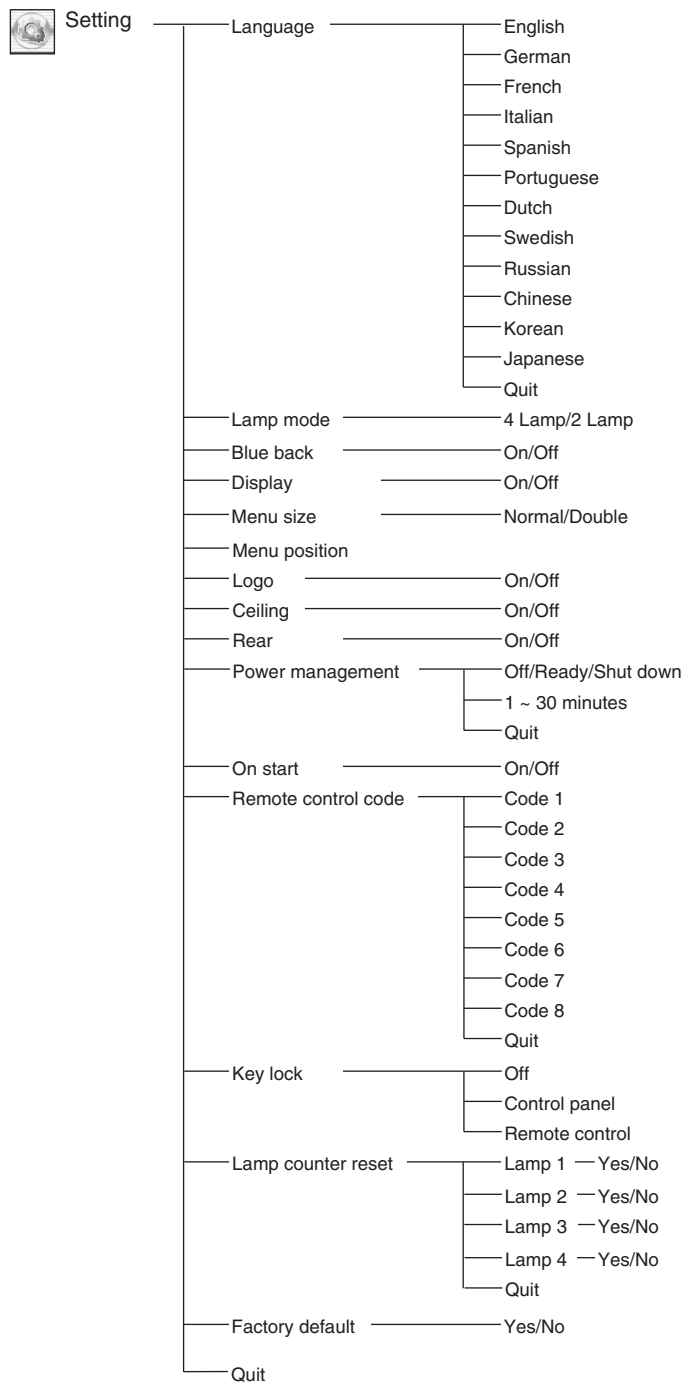
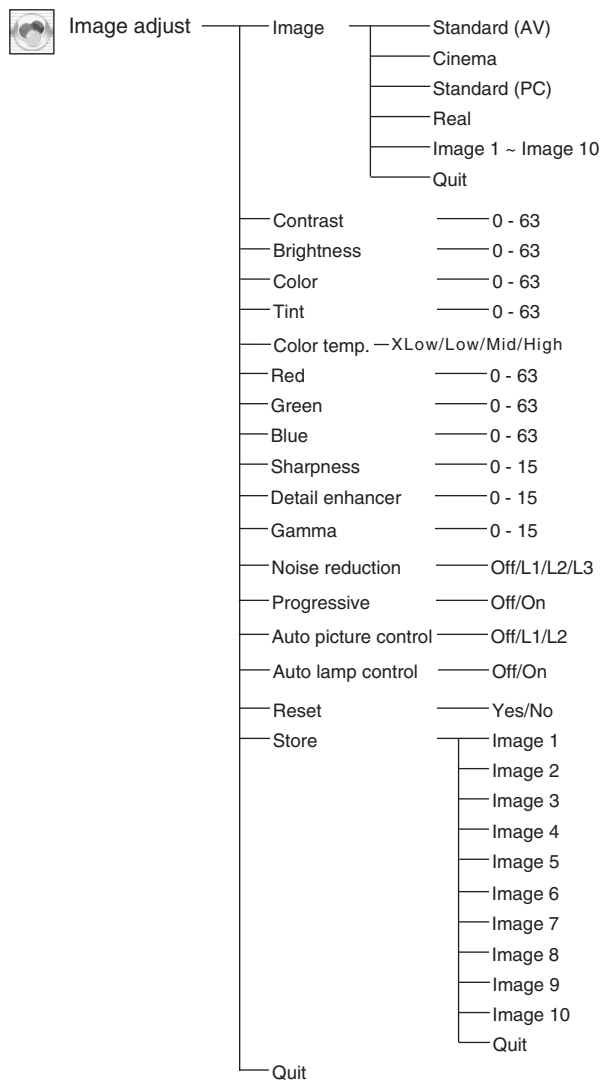

TECHNICAL SPECIFICATIONS

Projector Type	Multi-media Projector
Dimensions (W x H x D)	22.9" x 10" x 30.9" (581 mm x 252 mm x 783 mm)
Net Weight	83.9 lbs (38 kg)
LCD Panel System	1.65" TFT Active Matrix type, 3 panels
Panel Resolution	1920 x 1080 dots
Number of Pixels	6,220,800 (1920 x 1080 x 3 panels)
Color System	PAL, SECAM, NTSC, NTSC4.43, PAL-M and PAL-N
High Definition TV Signal	480i, 480p, 575i, 575p, 720p, 1035i, 1080i-50 and 1080i-60
Motorized Lens Shift	Up, Down, Left and Right
Scanning Frequency	H-sync. 15 ~ 120 KHz, V-sync. 50 ~ 120 Hz
Horizontal Resolution	1100 TV lines (HDTV)
Projection Lamp	250 watt type x 4
Input 1 Jacks	BNC Type x 3 (SDI Input 1, SDI Input-2 and SDI Output)
Input 2 Jacks	BNC Type x 5 (R/Pr, G/Y, B/Pb, H/HV and V), RCA Type (Audio R and L) and DIN 8-pin (Control port)
Input 3 Jacks	DVI-I Terminal (Digital/Analog), RCA Type (Audio R and L) and DIN 8-pin (Control port)
Other Jacks	Serial port in (DB 9), Serial port out (DB 9), USB port and Audio Monitor out (RCA Type R and L)
Built-in Speakers	INT. SP. Stereo (R and L), 3 watt RMS (T.H.D. 10%)
Remote Control Transmitter	Power Source : AA, UM3 or R06 Type x 2 Operating Range : 16.4' (5m) / ±30° Dimensions : 2.0" x 1.0" x 7.1" (50mm x 27mm x 118mm) Net Weight : 0.34 lbs (154 g) (including batteries)
Feet Adjustment	0° to 5.7°
Voltage and Power Consumption	AC 120 V (12 A Max. Ampere), 50 / 60 Hz (The U.S.A and Canada) AC 200 ~ 240 V (7.5 A Max. Ampere), 50 / 60 Hz (Continental Europe and The U.K.)
Operating Temperature	41 °F ~ 95 °F (5 °C ~ 35 °C)
Storage Temperature	14 °F ~ 140 °F (-10 °C ~ 60 °C)
Accessories	Owner's Manual AC Power Cord Wireless/Wired Remote Control Transmitter and Batteries Remote Control Cable DVI-VGA Cable and DVI Cable MAC/VGA Adapter 6 Types Light-Block Sheet (For option lens) 2 Types Lens Attachment (For option lens) Protective Dust Cover

- Specifications are subject to change without notice.
- LCD panels are manufactured to the highest possible standards. At least 99.99% of the pixels are effective, however a tiny fraction of the pixels (0.01% or less) may be ineffective by the characteristics of the LCD panels.

CONFIGURATIONS OF TERMINALS

DVI-I TERMINAL (DIGITAL/ANALOG)

This terminal accepts only Digital (TMDS) or Analog (RGB) output signal. Connect display output terminal of computer to this terminal with DVI cable (supplied).

Pin Configuration

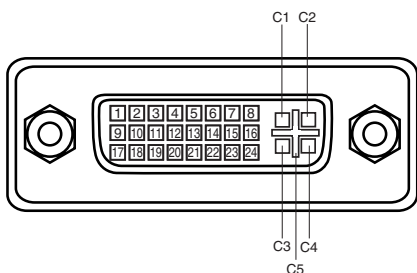

C1	Analog Red Input
C2	Analog Green Input
C3	Analog Blue Input
C4	Analog Horiz. sync
C5	Analog Ground (R/G/B)

1	T.M.D.S. Data2-	9	T.M.D.S. Data1-	17	T.M.D.S. Data0-
2	T.M.D.S. Data2+	10	T.M.D.S. Data1+	18	T.M.D.S. Data0+
3	T.M.D.S. Data2 Shield	11	T.M.D.S. Data1 Shield	19	T.M.D.S. Data0 Shield
4	No Connect	12	No Connect	20	No Connect
5	No Connect	13	No Connect	21	No Connect
6	DDC Clock	14	+5V Power	22	T.M.D.S. Clock Shield
7	DDC Data	15	Ground (for +5V)	23	T.M.D.S. Clock+
8	Analog Vert. sync	16	Hot Plug Detect	24	T.M.D.S. Clock-

SERIAL PORT IN/OUT TERMINAL

Pin Configuration

Connect serial port output terminal of computer to this terminal with Serial Cable (not supplied).

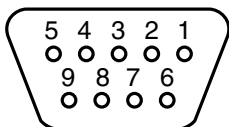

1	----
2	RxD
3	TxD
4	----
5	Ground
6	----
7	----
8	----
9	----

USB PORT TERMINAL

Pin Configuration

Connect USB port output terminal of computer or peripheral equipment to this terminal with USB port Cable (not supplied).

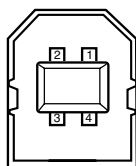

1	Vcc
2	- Data
3	+ Data
4	Ground

COMPATIBLE COMPUTER SPECIFICATIONS

Basically this projector can accept a signal from all computers with V, H-Frequency mentioned below and less than 230 MHz of Dot Clock.

ON-SCREEN DISPLAY	RESOLUTION	H-Freq. (kHz)	V-Freq. (Hz)	ON-SCREEN DISPLAY	RESOLUTION	H-Freq. (kHz)	V-Freq. (Hz)
VGA 1	640 x 480	31.47	59.88	XGA15	1024 x 768	58.03	72.0
VGA 2	720 x 400	31.47	70.09	MAC 19	1024 x 768	60.24	75.08
VGA 3	640 x 400	31.47	70.09	MAC 21	1152 x 870	68.68	75.06
VGA 4	640 x 480	37.86	74.38	SXGA 1	1152 x 864	64.20	70.40
VGA 5	640 x 480	37.86	72.81	SXGA 2	1280 x 1024	62.50	58.60
VGA 6	640 x 480	37.50	75.00	SXGA 3	1280 x 1024	63.90	60.00
VGA 7	640 x 480	43.269	85.00	SXGA 4	1280 x 1024	63.34	59.98
MAC LC13	640 x 480	34.97	66.60	SXGA 5	1280 x 1024	63.74	60.01
MAC 13	640 x 480	35.00	66.67	SXGA 6	1280 x 1024	71.69	67.19
480i	(Interlace)	15.734	60.00	SXGA 7	1280 x 1024	81.13	76.107
575i	(Interlace)	15.625	50.00	SXGA 8	1280 x 1024	63.98	60.02
480p	(Progressive)	31.47	59.88	SXGA 9	1280 x 1024	79.976	75.025
575p	(Progressive)	31.25	50.00	SXGA 10	1280 x 960	60.00	60.00
SVGA 1	800 x 600	35.156	56.25	SXGA 11	1152 x 900	61.20	65.20
SVGA 2	800 x 600	37.88	60.32	SXGA 12	1152 x 900	71.40	75.60
SVGA 3	800 x 600	46.875	75.00	SXGA 13	1280 x 1024 (Interlace)	50.00	86.00
SVGA 4	800 x 600	53.674	85.06	SXGA 14	1280 x 1024 (Interlace)	50.00	94.00
SVGA 5	800 x 600	48.08	72.19	SXGA 15	1280 x 1024	63.37	60.01
SVGA 6	800 x 600	37.90	61.03	SXGA 16	1280 x 1024	76.97	72.00
SVGA 7	800 x 600	34.50	55.38	SXGA 17	1152 x 900	61.85	66.00
SVGA 8	800 x 600	38.00	60.51	SXGA 18	1280 x 1024 (Interlace)	46.43	86.70
SVGA 9	800 x 600	38.60	60.31	SXGA 19	1280 x 1024	63.79	60.18
SVGA 10	800 x 600	32.70	51.09	SXGA 20	1280 x 1024	91.146	85.024
SVGA 11	800 x 600	38.00	60.51	SXGA 21	1400 x 1050	63.90	60.00
MAC 16	832 x 624	49.72	74.55	MAC	1280 x 960	75.00	75.08
XGA 1	1024 x 768	48.36	60.00	MAC	1280 x 1024	80.00	75.08
XGA 2	1024 x 768	68.677	84.997	WXGA 1	1366 x 768	48.36	60.00
XGA 3	1024 x 768	60.023	75.03	WXGA 2	1360 x 768	47.70	60.00
XGA 4	1024 x 768	56.476	70.07	WXGA 3	1376 x 768	48.36	60.00
XGA 5	1024 x 768	60.31	74.92	WXGA 4	1360 x 768	56.16	72.00
XGA 6	1024 x 768	48.50	60.02	UXGA 1	1600 x 1200	75.00	60.00
XGA 7	1024 x 768	44.00	54.58	UXGA 2	1600 x 1200	81.25	65.00
XGA 8	1024 x 768	63.48	79.35	UXGA 3	1600 x 1200	87.50	70.00
XGA 9	1024 x 768 (Interlace)	36.00	87.17	UXGA 4	1600 x 1200	93.750	75.00
XGA 10	1024 x 768	62.04	77.07	720p	(Progressive)	45.00	60.00
XGA 11	1024 x 768	61.00	75.70	1035i	(Interlace)	33.75	30.00
XGA 12	1024 x 768 (Interlace)	35.522	86.96	1080i/60	(Interlace)	33.75	60.00
XGA 13	1024 x 768	46.90	58.20	1080i/50	(Interlace)	28.125	50.00
XGA 14	1024 x 768	47.00	58.30				

When a input signal is digital from DVI terminal, refer to chart below.

ON-SCREEN DISPLAY	RESOLUTION	H-Freq. (kHz)	V-Freq. (Hz)	ON-SCREEN DISPLAY	RESOLUTION	H-Freq. (kHz)	V-Freq. (Hz)
D-VGA	640 x 480	31.47	59.94	D-SXGA1	1280 x 1024	63.98	60.02
D-480p	720 x 480 (Progressive)	31.47	59.88	D-SXGA2	1280 x 1024	60.276	58.069
D-575p	768 x 575 (Progressive)	31.25	50.00	D-SXGA3	1280 x 1024	31.65	29.8
D-SVGA	800 x 600	37.879	60.32	D-UXGA	1600 x 1200	75.00	60.00
D-XGA	1024 x 768	43.363	60.00	D-720p	1280 x 720 (Progressive)	45.00	60.00
D-WXGA1	1366 x 768	48.36	60.00	D-1035i	1920 x 1035 (Interface)	33.75	30.00
D-WXGA2	1360 x 768	47.70	60.00	D-1080i/60	1920 x 1080 (Interface)	33.75	30.00
D-WXGA3	1376 x 768	48.36	60.00	D-1080i/50	1920 x 1080 (Interface)	28.125	25.00
D-WXGA4	1360 x 768	56.16	60.00				

NOTE : Specifications are subject to change without notice.

OPTIONAL PARTS

The parts listed below are optionally supplied. When ordering those parts, give the name and Type No. to the sales dealer.

- **HDB 15 pin-SCART 21 pin Cable** **Type No. : POA-CA-SCART**
- **Terminal Board (Y/C)** **Type No. : POA-MD03VD2**
- **Terminal Board (Faroudja)** **Type No. : POA-MD09VD3**
- **Network Board** **Type No. : POA-MD19NET**

