

**TOSHIBA**

*OWNER'S MANUAL*

**DATA PROJECTOR**

---

**TDP-T350**

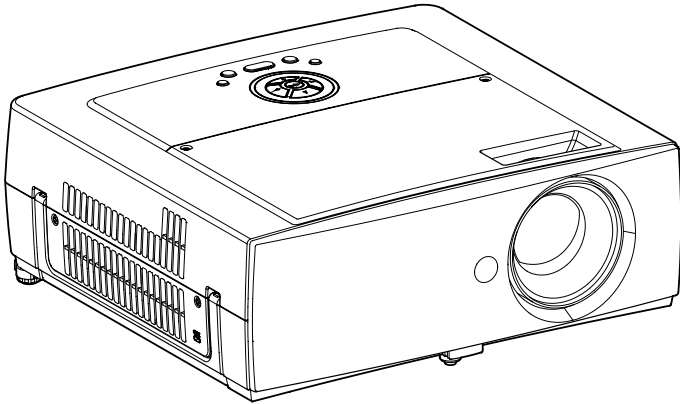

Before Using

Preparations

Operations

Maintenance

Others

# SAFETY PRECAUTIONS



The lightning flash with arrowhead symbol, within an equilateral triangle, is intended to alert the user to the presence of uninsulated "dangerous voltage" within the product's enclosure that may be of sufficient magnitude to constitute a risk of electric shock to persons.



The exclamation point within an equilateral triangle is intended to alert the user to the presence of important operating and maintenance (servicing) instructions in the literature accompanying the appliance.

**WARNING:** TO REDUCE THE RISK OF FIRE OR ELECTRIC SHOCK, DO NOT EXPOSE THIS APPLIANCE TO RAIN OR MOISTURE. DANGEROUS HIGH VOLTAGES ARE PRESENT INSIDE THE ENCLOSURE. DO NOT OPEN THE CABINET. REFER SERVICING TO QUALIFIED PERSONNEL ONLY.

**WARNING:** Handling the cord on this product or cords associated with accessories sold with this product, will expose you to lead, a chemical known to the State of California to cause birth defects or other reproductive harm. ***Wash hands after handling.***

**USA only**

**WARNING:** This [product] contains mercury. Disposal of mercury may be regulated due to environmental considerations. For disposal or recycling information, please contact your local authorities or the Electronic Industries Alliance: [www.eiae.org](http://www.eiae.org).

**USA only**

## MODEL NAME: TDP-T350

### FCC Radio Frequency Interference Statement

**Note:** This equipment has been tested and found to comply with the limits for a Class A digital device, pursuant to part 15 of the FCC Rules. These limits are designed to provide reasonable protection against harmful interference when the equipment is operated in a commercial environment. This equipment generates, uses, and can radiates radio frequency energy and, if not installed and used in accordance with the instruction manual, may cause harmful interference to radio communications. Operation of this equipment in a residential area is likely to cause harmful interference in which case the user will be required to correct the interference at his own expense.

**USA only**

**WARNING:** Changes or modifications made to this equipment, not expressly approved by Toshiba, or parties authorized by Toshiba, could void the user's authority to operate the equipment.

**USA only**

**Notice:** This Class A digital apparatus complies with Canadian ICES-003. Cet appareil numérique de la classe A est conforme à la norme NMB-003 du Canada.

**CANADA only**

**WARNING:** This is a Class A product. In a domestic environment this product may cause radio interference in which case the user may be required to take adequate measures.

# IMPORTANT SAFETY INSTRUCTIONS

**CAUTION: PLEASE READ AND OBSERVE ALL WARNINGS AND INSTRUCTIONS GIVEN IN THIS OWNER'S MANUAL AND THOSE MARKED ON THE UNIT. RETAIN THIS BOOKLET FOR FUTURE REFERENCE.**

This unit is fully transistorized and does not contain any parts that can be repaired by the user.

**DO NOT REMOVE THE CABINET COVER, OR YOU MAY BE EXPOSED TO DANGEROUS VOLTAGE. REFER SERVICING TO QUALIFIED SERVICE PERSONNEL ONLY.**

## 1. Read Owner's Manual

After unpacking this product, read the owner's manual carefully, and follow all the operating and other instructions.

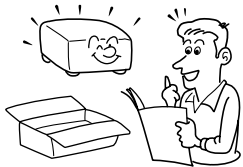

## 2. Power Sources

This product should be operated only from the type of power source which does not exceed the voltage range specified on the rating label and the power cord. If you are not sure of the type of power supply to your home, consult your product dealer or local power company.



## 3. Source of Light

Do not look into the lens while the lamp is on. The strong light from the lamp may cause damage to your eyes or sight.

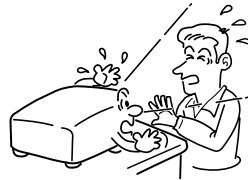

## 4. Ventilation

Openings in the cabinet are provided for ventilation and to ensure reliable operation of the product and to protect it from overheating, and these openings must not be blocked or covered. The openings should never be blocked by placing the product on a bed, sofa, rug or other similar surface. This product should not be placed in a built-in installation such as a bookcase or rack unless proper ventilation is provided.

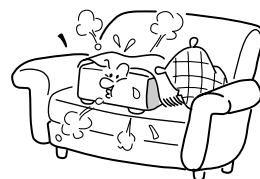

## 5. Heat

The product should be situated away from heat sources such as radiators, heat registers, stoves, or other products (including amplifiers) that produce heat.

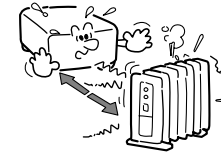

## 6. Water and Moisture

Do not use this product near water. - for example, near a bath tub, wash bowl, kitchen sink, or laundry tub; in a wet basement; or near a swimming pool and the like.

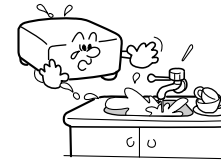

## 7. Cleaning

Unplug this product from the wall outlet before cleaning. Do not use liquid cleaners or aerosol cleaners. Use a soft cloth for cleaning.

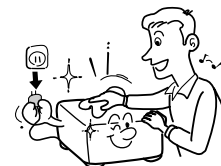

## 8. Power-Cord Protection

Power-supply cords should be routed so that they are not likely to be walked on or pinched by items placed upon or against them, paying particular attention to cords at plugs, convenience receptacles, and the point where they exit from the product.



## 9. Overloading

Do not overload wall outlets; to reduce the risk of electric shock, do not use the polarized plug with an extension cord, receptacle, or other outlet unless the blades can be inserted completely with three-wire grounding type to prevent blade exposure. As this can result in a risk of fire or electric shock.



## IMPORTANT SAFETY INSTRUCTIONS (Continued)

### 10. Lightning storms

For added protection for this product during storm, or when it is left unattended and unused for long periods of time, unplug it from the wall outlet. This will prevent damage to the product due to lightning and power-line surges. However, while it is thundering or lightning, do not touch the apparatus and any connected cable and/or equipment. This will prevent you from receiving the electric shock by an electric surge.

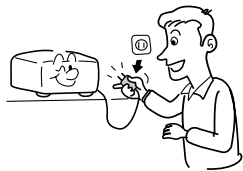

### 11. Object and Liquid Entry

Never push objects of any kind into this product through openings as they may touch dangerous voltage points or short-out parts that could result in a fire or electric shock. Never spill liquid of any kind on the product.



### 12. Do not place the product vertically

Do not use the product in the upright position to project the pictures at the ceiling, or any other vertical positions. It may fall down and dangerous.

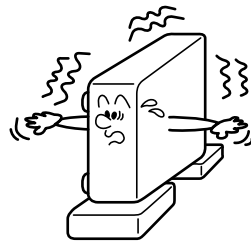

### 13. Stack Inhibited

Do not stack other equipment on this product or do not place this product on the other equipment. Top and bottom plates of this product develops heat and may give some undesirable damage to other unit.



### 14. Attachments

Do not use attachments not recommended by the product manufacturer as they may cause hazards.

### 15. Accessories

Do not place this product on an unstable cart, stand, tripod, bracket, or table. The product may fall, causing serious injury to a child or adult, and serious damage to the product. A product and cart combination should be moved with care. Quick stops, excessive force, and uneven surfaces may cause the product and cart combination to overturn.



### 16. Damage Requiring Service

Unplug this product from the wall outlet and refer servicing to qualified service personnel under the following conditions:

- When the power-supply cord or plug is damaged.
- If liquid has been spilled, or objects have fallen into the product.
- If the product has been exposed to rain or water.
- If the product does not operate normally by following the operating instructions. Adjust only those controls that are covered by the operating instructions as an improper adjustment of other controls may result in damage and will often require extensive work by a qualified technician to restore the product to its normal operation.

- If the product has been dropped or damaged in any way (If the cabinet should break, please handle with care to avoid injury).
- When the product exhibits a distinct change in performance - this indicates a need for service.

### 17. If glass components, including lens and lamp, should break, contact your dealer for repair service.

This product incorporates glass components, including a lens and a lamp. If such parts should break, please handle with care to avoid injury and contact your dealer for repair service. The broken pieces of glass may cause to injury. In the unlikely event of the lamp rupturing, thoroughly clean the area around the projector and discard any edible items placed in that area.

### 18. Servicing

Do not attempt to service this product yourself as opening or removing covers may expose you to dangerous voltage or other hazards. Refer all servicing to qualified service personnel.





## IMPORTANT SAFETY INSTRUCTIONS (Continued)

### 19. Replacement Parts

When replacement parts are required, be sure the service technician has used replacement parts specified by the manufacturer or have the same characteristics as the original part. Unauthorized substitutions may result in fire, electric shock, or other hazards. (Replacement of the lamp only should be made by users.)

### 20. Safety Check

Upon completion of any service or repairs to this product, ask the service technician to perform safety checks to determine that the product is in proper operating condition.

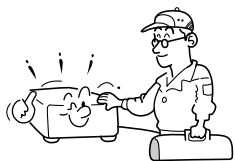

### 21. Do not leave thermal-paper documents or easily deformed items on top of the unit or near the air exhaust for long periods of time.

The heat from the unit could erase the information on the thermal paper, or cause deformation or warping.

### 22. Do not use the product in a closed installation state.

Do not place the product in a box or in any other closed installation state. Otherwise it may overheat. This could result in a risk of fire.

### 23. Do not look into the laser light source of the remote control or direct the laser pointer toward a person or a mirror.

The laser beam may cause damage to the eyes or sight.

## POWER SUPPLY CORD SELECTION

If your line voltage is 220 to 240V, use one of the following types of cable.

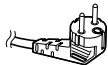
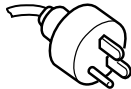
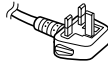
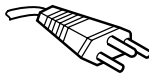
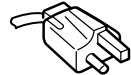
Plug configuration	Plug type	Line voltage	Plug configuration	Plug type	Line voltage
	EURO	220 – 240V		Australian 240V 10A	200 – 240V
	UK	220 – 240V		Switzerland 240V 6A	200 – 240V
				North American 240V 15A	200 – 240V

Use a 5A fuse which is approved by ASTA or BSI to BS1362. Always replace the fuse cover after changing the fuse.

## IMPORTANT PRECAUTIONS

### Save Original Packing Materials

The original shipping carton and packing materials will come in handy if you ever have to ship your projector. For maximum protection, repack the set as it was originally packed at the factory.

### Moisture Condensation

Never operate this unit immediately after moving it from a cold location to a warm location. When the unit is exposed to such a change in temperature, moisture may condense on the lens and the crucial internal parts. To prevent the unit from possible damage, do not use the unit for at least 2 hours when there is an extreme or sudden change in temperature.

### Place and Manner of Installation

- Do not place in hot locations, such as near heating equipment. Doing so could cause malfunction, and shorten the life of the projector.
- Avoid locations with oil or cigarette smoke. Doing so will dirty the optical parts, shortening their lives, and darkening the screen.
- Do not use this product in the upright position or tilt it up or down by more than 20° from level. Doing so may cause a failure or shorten the life of the product.
- Using this instrument near a TV or radio may cause interference to the images or audio sound. If this happens, move it away from the TV or radio.
- Moving the projector from a low-temperature room to a high-temperature room may cause condensation on the lens or internal parts in the instrument. If you continue to use it in that situation, the malfunction may result. Ensure to wait until the condensation naturally disappears.
- In a high altitude location where air is thin, cooling efficiency is reduced so use the projector with [Fan mode] set to [High]. [p.44](#)

## IMPORTANT PRECAUTIONS (Continued)

### Avoid Volatile Liquid

Do not use volatile liquids, such as an insect spray, near the unit. Do not leave rubber or plastic products touching the unit for a long time. They will leave marks on the finish. If cleaning with a chemically saturated cloth, be sure to follow the product's precautions.

## EXEMPTION CLAUSES

- Toshiba Corporation bears no responsibility in the case of damages arising from natural disaster such as earthquakes, lightning, etc., fire not liable to Toshiba Corporation, acts by third parties, other accidents, or use under abnormal conditions including erroneous or improper operation and other problems.
- Toshiba Corporation bears no responsibility for incidental damages (lost profit, work interruption, corruption or loss of the memory contents, etc.) arising from the use of or the inability to use this unit.
- Toshiba Corporation accepts no liability whatsoever for any damages arising from not having followed the descriptions in this Instruction Manual.
- Toshiba Corporation accepts no liability whatsoever for any damages arising from malfunctions arising from combination with equipment or software that is not related to Toshiba Corporation.

In the spaces provided below, record the Model and Serial No. located at the bottom of your projector.

Model No. \_\_\_\_\_ Serial No. \_\_\_\_\_

Retain this information for future reference.

## OTHER CAUTIONS AND INFORMATIONS

### Copyrights

Showing or transmitting commercial imaging software or broadcast or cable-broad casting programs with the purpose of other than the personal and private viewing, including modifying images using the freeze, resize, PIP, or SPLIT screen functions, or displaying with the varying aspect ratio of the images, could violate the direct or indirect copyrights of the imaging software or broadcast program, etc., if done without first consulting with the copyright holder. For this reason, please take appropriate measures before performing one of the actions listed above, including obtaining a license from the copyright holder.

### Disposal

This product contains substances which are harmful to humans and the environment.

- The lamp contains mercury.

Please dispose of this product or used lamps in accordance with local regulations.

### Trademarks

- VGA, SVGA, XGA, SXGA, UXGA are trademarks or registered trademarks of International Business Machines Corporation.
- Digital Light Processing, Digital Micromirror Device and DMD are trademarks of Texas Instruments.
- Macintosh is a registered trademark of Apple Computer, Inc.
- Windows is a registered trademark of Microsoft Corporation in the U.S. and other countries.
- Adobe is a registered trademark and Acrobat Reader is a trademark of Adobe Systems Incorporated.

### Notational Conventions Used in This Manual

- References to pages with related information are annotated as follows.  
For example, if making a reference to page 36: [p.36](#)
- The illustrations in this document are for reference purposes only and may not reflect your package exactly.

## REMOTE CONTROL BATTERIES

### Caution

- Never throw batteries into a fire.

Using the batteries improperly may cause them to explode or leak and lead to burn or injury. If battery-leaking fluid contacts skin, wash the fluid off immediately with clean water and consult a doctor. If the fluid is spilt on an instrument, avoid contact and wipe it off using tissue paper. (Dispose of the used tissue paper as flammable garbage after moistening with water.)

### Notes

- Be sure to use AAA (LR03) size batteries.
- Dispose of batteries in a designated disposal area.
- Attention should be drawn to the environmental aspects of battery disposal.
- Do not mix different battery types or combine used batteries with new ones.
- If the remote control does not operate correctly, or if the operating range becomes reduced, replace both batteries with new ones.
- If the batteries are dead or if you will not be using the remote control for a long time, remove the batteries to prevent battery acid from leaking into the battery compartment.

# CONTENTS

## Before Using

SAFETY PRECAUTIONS .....	2
IMPORTANT SAFETY INSTRUCTIONS .....	4
POWER SUPPLY CORD SELECTION .....	9
IMPORTANT PRECAUTIONS .....	9
EXEMPTION CLAUSES .....	10
OTHER CAUTIONS AND INFORMATIONS .....	11
REMOTE CONTROL BATTERIES .....	11
CONTENTS .....	12

## Preparations

Checking the package contents .....	14
Names of each part on the main unit .....	15
Names of each part on the control panel and remote control .....	16
Label locations .....	17
Parts on the rear panel .....	18
Preparing and using the remote control .....	20
Operating a computer using the remote control .....	21
Placement .....	22
Connection .....	24

## Operations

Turning the power on and off .....	26
Basic operations .....	28
Using handy features .....	30
Using auto setting .....	30
Correcting the keystone distortion .....	30
Resizing image .....	31
Cutting off the picture and sound temporarily (Mute) .....	32
Changing picture mode .....	33
Changing screen size .....	33
Freezing the image (Freeze) .....	33
Display a sub screen (PIP function) .....	34
Sub screen setting .....	34
Displaying two screens (SPLIT function) .....	35
SPLIT function setting .....	35
Screen combination of PIP and SPLIT functions .....	36
Password function .....	36
Using the menus .....	38
How to use the menus .....	38
The image adjustment menu .....	39
The display setting menu .....	41
The default setting menu .....	44
The control setting menu .....	46
Displaying Information (Status display) .....	48

## Maintenance

About lamp .....	49
Lamp replacement .....	49
Lens and main unit cleaning .....	52

## Others

Trouble indications .....	53
Before calling service personnel .....	54
Specifications .....	55
List of general specifications .....	55
Separately sold product .....	55
List of supported signals (RGB signals) .....	56
List of supported signals (Y/Pb/Pr signals) .....	57
List of supported signals (Video, S-Video signals) .....	57
Pin assignment of COMPUTER-2 & MONITOR terminals .....	57
Pin assignment of DVI-I terminal .....	58
CONTROL terminal .....	59

# Checking the package contents

Please make sure that the following items are included in the box, along with the main unit. If any item is missing, please contact the store immediately where you purchased the product.

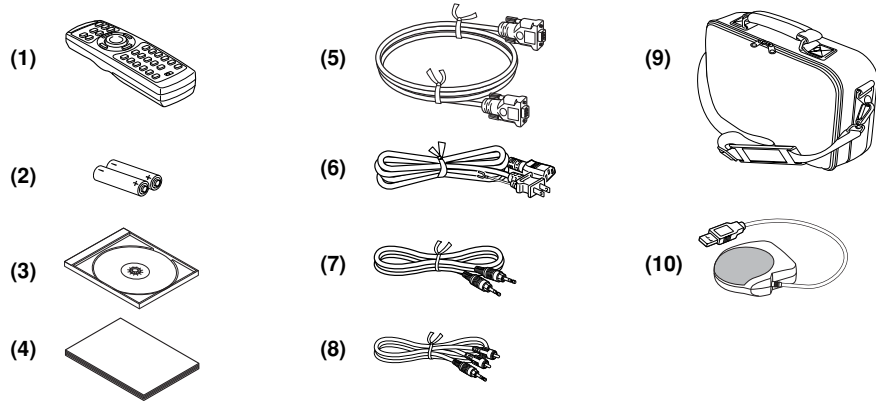

- (1) Remote control
- (2) LR03 (SIZE AAA) batteries for remote control (2)
- (3) CD-ROM
- (4) Owner's Manual
- (5) RGB cable (3m)
- (6) Power cord (See note)
- (7) Audio cable (for computer input)
- (8) Audio cable (for video input)
- (9) Carrying bag
- (10) Mouse remote control receiver

### Note

The shape and number of supplied power cords vary depending on the product destination.

## ◆The Supplied CD-ROM

The supplied CD-ROM contains an owner's manual, including information not available for the printed Owner's manual (Getting started) and Acrobat® Reader™ to view the manual.

### ■ Installing Acrobat® Reader™

Windows®: Run the CD-ROM, select the **Reader/English** folder, and run **ar500enu.exe**. Follow the on-screen instructions.

Macintosh: Run the CD-ROM, select the **Reader/English** folder, and run **Reader Installer**. Follow the on-screen instructions to install the software.

### ■ Viewing the manual

Run the CD-ROM and double-click on **Start.pdf**. Acrobat® Reader™ launches, and the menu screen of the Owner's manual appears. Click on your language. The Owner's Manual cover and list of bookmarks appear. Click on a bookmark title to view that section of the manual. Click on **p.** to view a reference page with related information. See the Help menu for more information about Acrobat® Reader™.

# Names of each part on the main unit

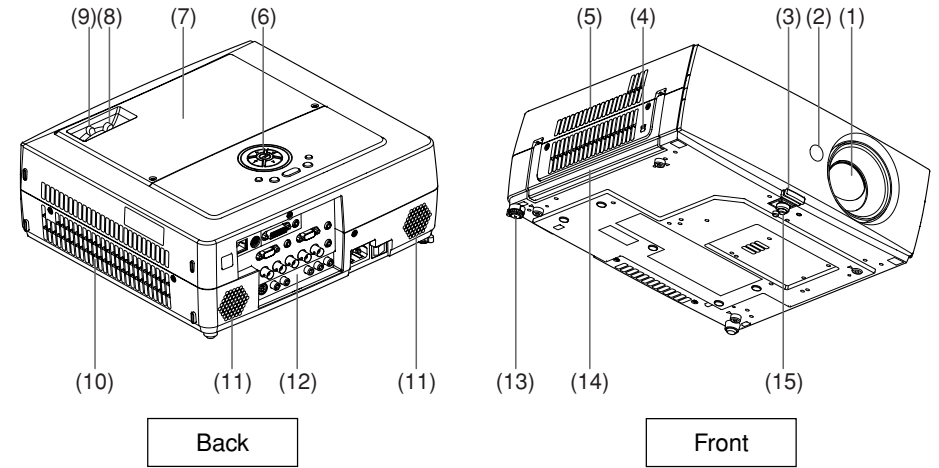

Name	Function
(1) Lens	: Projects expanded image.
(2) Infrared remote sensor	: Senses commands from the remote control. <a href="#">p.20</a>
(3) Foot adjuster release button	: Press to set up or stow the foot adjuster. <a href="#">p.29</a>
(4) Antitheft lock hole	: Attach a safety cable or any other antitheft device.
(5) Air exhaust	: Expels air that has grown hot inside the projector.
(6) Control panel	: Operates the projector. <a href="#">p.16</a>
(7) Lamp cover	: Remove to replace lamp. <a href="#">p.50</a>
(8) Zooming lever	: Adjusts screen size. <a href="#">p.29</a>
(9) Focusing lever	: Adjusts screen focus. <a href="#">p.29</a>
(10) Air intake	: Draws in air from outside the projector.
(11) Speaker	: Outputs audio sound.
(12) Rear panel	: Connects external devices. <a href="#">p.18</a>
(13) Tilt adjuster	: Adjusts the projector's horizontal tilt. <a href="#">p.29</a>
(14) Handle	: Hold to carry the projector.
(15) Foot adjuster	: Adjusts the vertical projection angle. <a href="#">p.29</a>

# Names of each part on the control panel and remote control

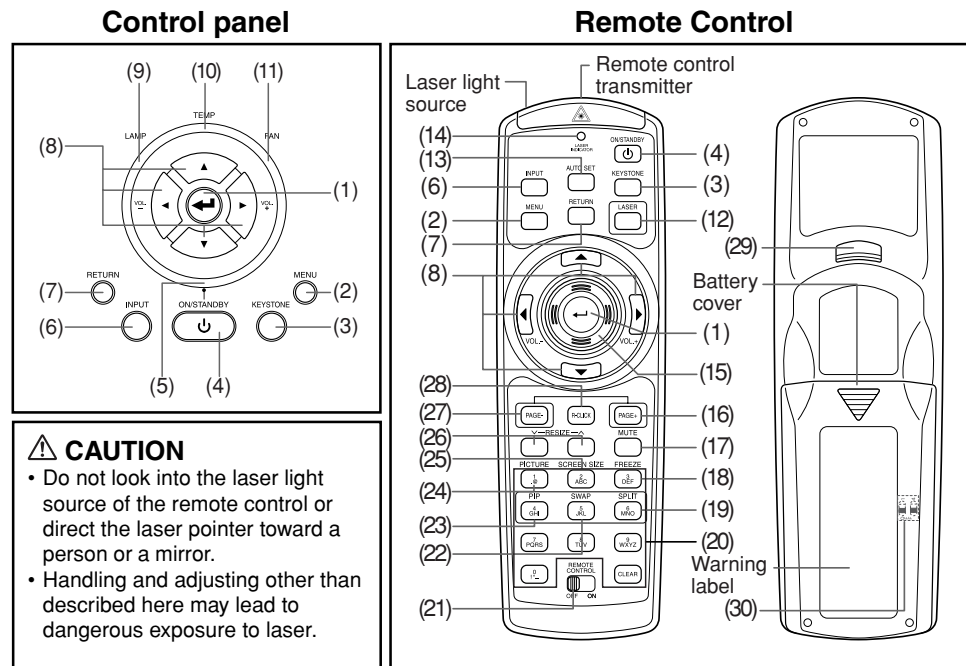

**CAUTION**

- Do not look into the laser light source of the remote control or direct the laser pointer toward a person or a mirror.
- Handling and adjusting other than described here may lead to dangerous exposure to laser.

Name	Main Function
(13) AUTO SET button	Sets up analog input from computer. <a href="#">p.30</a>
(14) Laser indicator	Lights when laser is on.
(15) Mouse control button	Controls a mouse pointer. <a href="#">p.21</a>
(16) PAGE+ button	Proceeds PowerPoint® slides. <a href="#">p.21</a>
(17) MUTE button	Cuts off the picture and sound temporarily. <a href="#">p.32</a>
(18) FREEZE button	Pauses image. <a href="#">p.33</a>
(19) SPLIT button	Displays two screens. <a href="#">p.35</a>
(20) Ten-Key button	Use as a ten-key pad with wired LAN, from which numbers and characters can be entered. <a href="#">p.47</a>
(21) Remote control ON/OFF switch	Switches on/off the remote control. <a href="#">p.20</a>
(22) SWAP button	Swaps the main screen and the sub screen in PIP mode, or swaps the two screens in SPLIT mode. <a href="#">p.34</a>
(23) PIP button	Displays the sub screen. <a href="#">p.34</a>
(24) PICTURE button	Changes image mode. <a href="#">p.33</a>
(25) SCREEN SIZE button	Changes screen size. <a href="#">p.33</a>
(26) RESIZE button	Enlarges image. <a href="#">p.31</a>
(27) PAGE- button	Goes back PowerPoint® slides. <a href="#">p.21</a>
(28) R-CLICK button	Functions as right-click of a mouse. <a href="#">p.21</a>
(29) L-CLICK button	Functions as left-click of a mouse. <a href="#">p.21</a>
(30) Remote control code switch (inside the battery cover)	Sets the code of remote control to that of the projector. <a href="#">p.45</a>

**Note**

- For the remainder of this manual, buttons are referred to as follows:  
Selection buttons ⇒ ▲ ▼ ◀ ▶; ENTER button ⇒ ⏎

Name	Main Function
------	---------------

## Control panel

- (1) ENTER button : Accepts the selected mode.
- (2) MENU button : Displays menus. [p.38](#)
- (3) KEYSTONE button : Adjusts keystone distortion. [p.30](#)
- (4) ON/STANDBY button : Turns the power on/off (standby). [p.26](#)
- (5) ON/STANDBY indicator : Displays whether power is on or off. [p.26](#)
- (6) INPUT button : Selects input. [p.28](#)
- (7) RETURN button : Goes back one screen.
- (8) Selection button : Menu selections and adjustments, volume control, etc. [p.38](#)
- (9) LAMP indicator : Displays lamp mode. [p.27](#)
- (10) TEMP indicator : Lights when internal temperature is too high. [p.53](#)
- (11) FAN indicator : Displays cooling fan mode. [p.53](#)

## Remote control

- (1) ENTER button : Accepts the selected mode.
- (2) MENU button : Displays menus. [p.38](#)
- (3) KEYSTONE button : Adjusts keystone distortion. [p.30](#)
- (4) ON/STANDBY button : Turns the power on/off (standby). [p.26](#)
- (6) INPUT button : Selects input. [p.28](#)
- (7) RETURN button : Goes back one screen.
- (8) Selection button : Menu selections and adjustments, volume control, etc. [p.38](#)
- (12) LASER button : Shows a laser pointer.

## Label locations

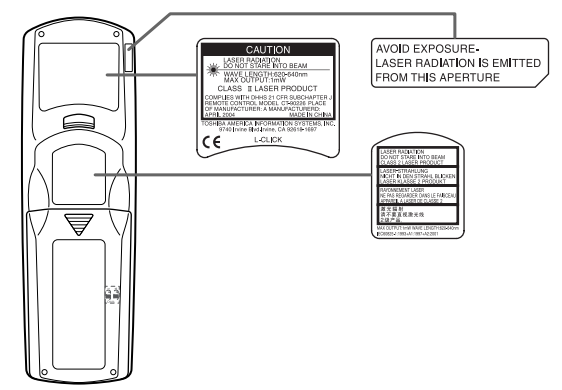

**Caution** – use of controls or adjustments or performance of procedures other than those specified herein may result in hazardous radiation exposure.

# Parts on the rear panel

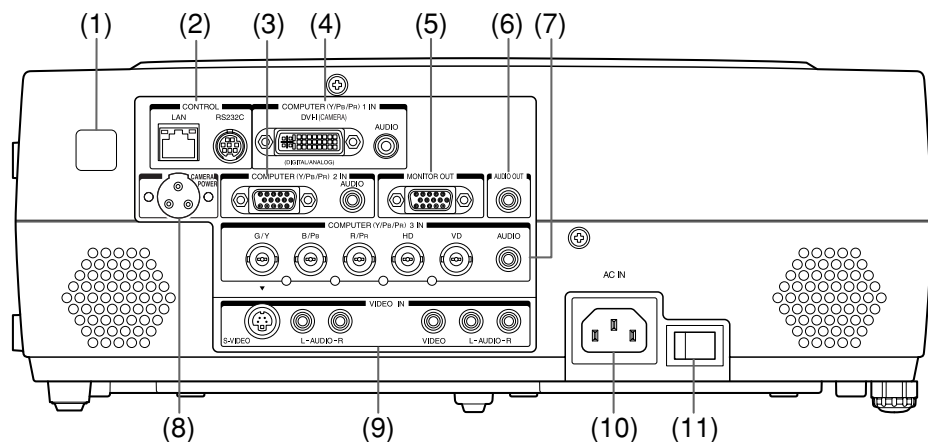

Name	Main Function
(9) VIDEO IN terminal	S-VIDEO : Input S video signals from video equipment. AUDIO (L/R) : Input audio signals from video equipment. VIDEO : Input video signals from video equipment. AUDIO (L/R) : Input audio signals from video equipment.
(10) AC IN socket	: Connect the supplied power cord here.
(11) Main power switch	: AC power line ON (standby)/OFF.

Name	Main Function
(1) Infrared remote sensor	: Senses commands from the remote control. <a href="#">p.20</a>
(2) CONTROL terminal	LAN : Connects a network cable. RS232C : When operating the projector via a computer, connect this to the controlling computer's RS-232C port. <a href="#">p.59</a>
(3) COMPUTER (Y/Pb/Pr) 2 IN terminal	RGB : Input analog RGB signal from a computer or other source, or a component video signal (Y/Pb/Pr) from video equipment. AUDIO : Input audio signals.
(4) COMPUTER (Y/Pb/Pr) 1 IN terminal	DVI-I : Input analog or digital RGB signal from a computer, or a component video signal (Y/Pb/Pr) from video equipment. AUDIO : Input audio signals.
(5) MONITOR terminal	: Connect to a computer display, etc.
(6) AUDIO OUT terminal	: Outputs audio signals.
(7) COMPUTER (Y/Pb/Pr) 3 IN terminal	BNC : Input G/B/R/HD/VD signal from a computer, or a component video signal (Y/Pb/Pr) from video equipment. AUDIO : Input audio signals.
(8) CAMERA POWER terminal	: DC power supply terminal (+15 V). Reserved for future use.



# Preparing and using the remote control

## ■ Loading dry-cell batteries into the remote control

### ① Remove the battery cover.

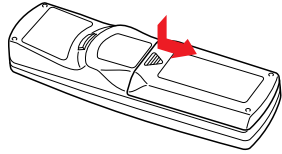

### ② Insert the dry-cell batteries.

Be sure to align the plus and minus ends of the batteries properly.

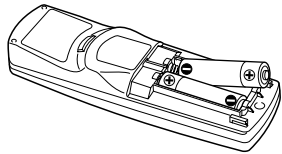

Two batteries (LR03, SIZE AAA) are used.

### ③ Replace the battery cover.

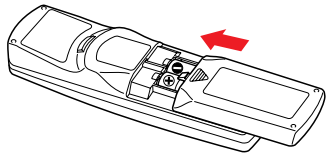

## ■ Dry-cell batteries

- Before using the batteries, be sure to observe the Safety Precautions described in previous pages.
- Remove batteries from remote control when not using for extended periods.
- If the remote control stops working, or if its range decreases, replace all the batteries with new ones.

## ■ The remote control

- Turn off the ON/OFF switch of the remote control when not in use or to store in baggage.
- The remote control may fail to operate if the infrared remote sensor is exposed to bright sunlight or fluorescent lighting.
- Do not drop or bang.
- Do not leave in hot or humid locations.
- Do not get wet or place on top of wet objects.
- Do not take apart.
- In rare cases, ambient conditions could impede the operation of the remote control. If this happens, point the remote control at the main unit again, and repeat the operation.

## ■ Operating the remote control

Turn on the ON/OFF switch of the remote control.

Point toward the projector's infrared remote sensor, and press a button on the remote control.

- Operating the projector from the front

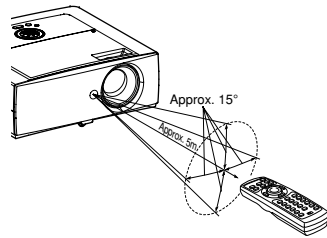

- Operating the projector from the rear

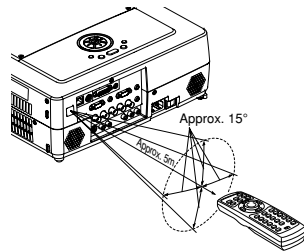

# Operating a computer using the remote control

A computer can be operated using the projector's remote control. This function is available on any computer with the Windows 98/98SE, Windows Me, Windows 2000, or Windows XP OS, that is equipped with a USB port which can support USB1.1 (The mouse remote control receiver is also supported on OS 9 or OS X for the Macintosh). However, please note that Toshiba does not guarantee the operation of all computers.

## ① Connecting a computer

Connect the mouse remote control receiver (supplied) to a computer.

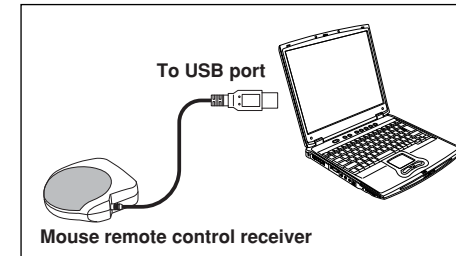

The remote control may fail to operate if the mouse remote control receiver is exposed to bright sunlight or fluorescent lighting.

In such a case, change position or direction of the mouse remote control receiver and retry.

## ② Operating a computer

Operate remote control's buttons towards the mouse remote control receiver.

### ● Moving the mouse pointer

Press the mouse control button in the direction you wish the mouse pointer to move, then press.

### ● To left click

Press the L-CLICK button.

### ● To right click

Press the R-CLICK button.

### ● To drag and drop

Holding down the L-CLICK button, move the mouse control button until the mouse pointer is over the desired location, then release the L-CLICK button.

### ● Using the computer's page up [↑] and down [↓] function

Press the PAGE+ and PAGE- buttons to switch PowerPoint® slides.

Remote Control Front

Remote Control Rear

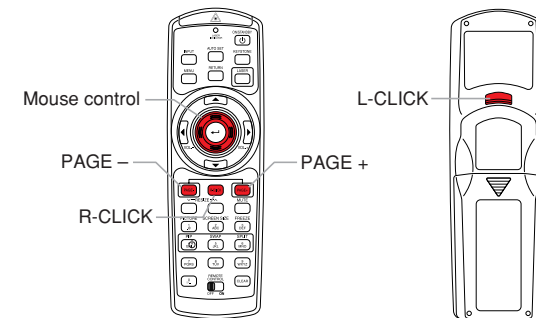

# Placement

## Placement Styles

As shown in the figures below, this device can be placed in 4 different styles. The factory setting is “floor-mounted front projection.” Set the [Projection mode] in the Default setting menu [p.44](#), in accordance with your needs.

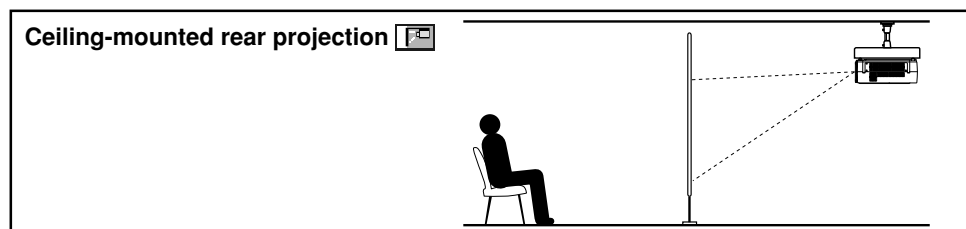
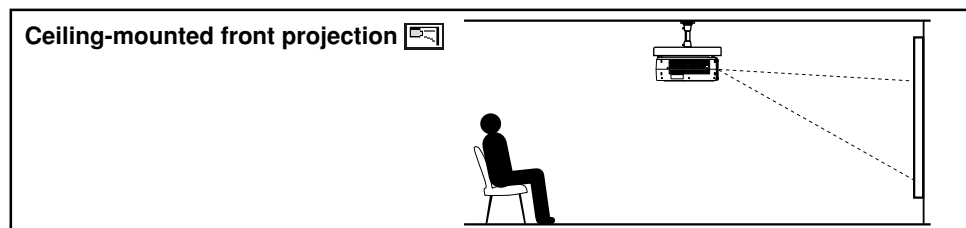
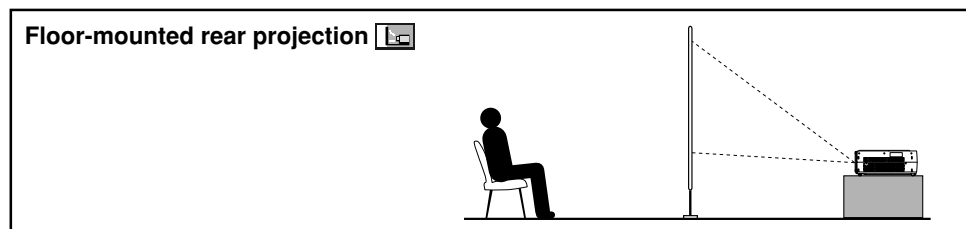
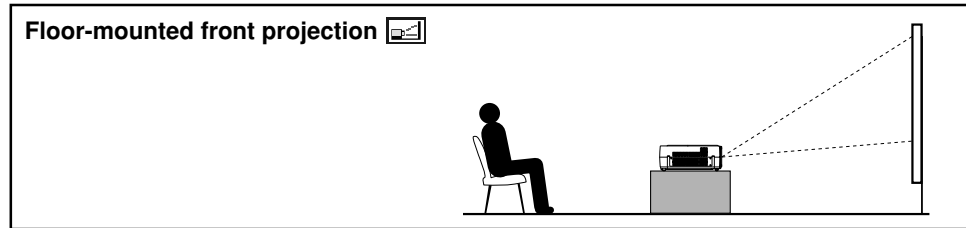

### WARNING

- Always obey the instructions listed in IMPORTANT SAFETY INSTRUCTIONS when placing the unit. Attempting to clean/replace the lamp at a high site by yourself may cause you to drop down, thus resulting in injury.
- If you wish to mount the projector on the ceiling, be sure to ask your dealer to do so. Mounting the projector on a ceiling requires special ceiling brackets (sold separately) and specialized knowledge. Improper mounting could cause the projector to fall, resulting in an accident.
- If the projector is ceiling-mounted, install the breaker for turning off the power in case of anomaly. Let everyone involved with the use of the projector know that fact.

## Projection Distance and Size

Use the figures, tables, and formulas below to determine the projection size and projection distance. (Projection sizes are approximate values for full-size picture with no keystone adjustment.)

Screen **As seen from above**

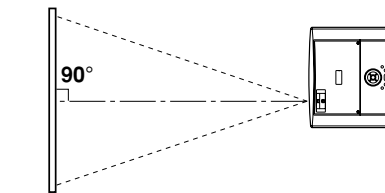

**As seen from the side**

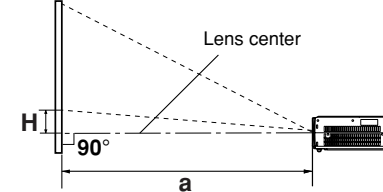

$$a \text{ (min length)} = \frac{\text{projection size (inches)} - 1.4596}{29.888}$$

$$a \text{ (max length)} = \frac{\text{projection size (inches)} - 1.2084}{24.744}$$

projection size (inches)	projection distance a (m)		height (H) (cm)
	min length (zooming max)	max length (zooming min)	
33	—	1.29	6.8
40	1.29	1.57	8.2
60	1.96	2.38	12.3
80	2.63	3.18	16.5
100	3.30	3.99	20.6
150	4.97	6.01	30.9
200	6.64	8.03	41.1
250	8.32	10.05	51.4
300	9.99	12.08	61.7

**a** is the distance (m) between the lens and the screen, and corresponds to a range of 1.29 m to 12.10 m. **H** is the height from the image bottom to the center of the lens.



# Connection

## Before connection

- Read the owner's manual of the device you are connecting to the projector.
- Some types of computer cannot be used or connected to this projector.  
Check for an RGB output terminal, supported signal [p.56](#), etc.
- Turn off the power of both devices before connecting.
- The figures are sample connections.

## Connecting with computers

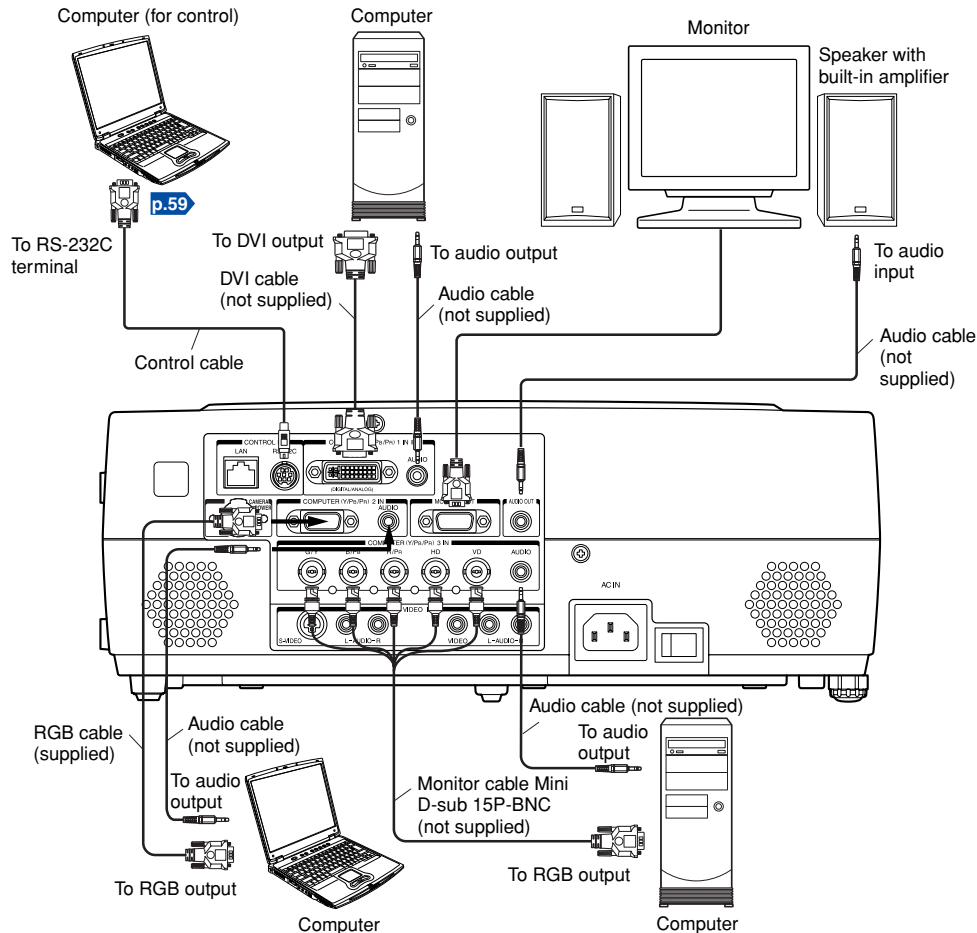

## Notes

- Signals are output from MONITOR OUT terminal even in standby mode.  
From AUDIO OUT terminal, no audio signal is output.
- Moving pictures played back on computers using DVD software may appear unnatural if it is projected with this projector, but it is not a malfunction.

## Connecting with AV equipment

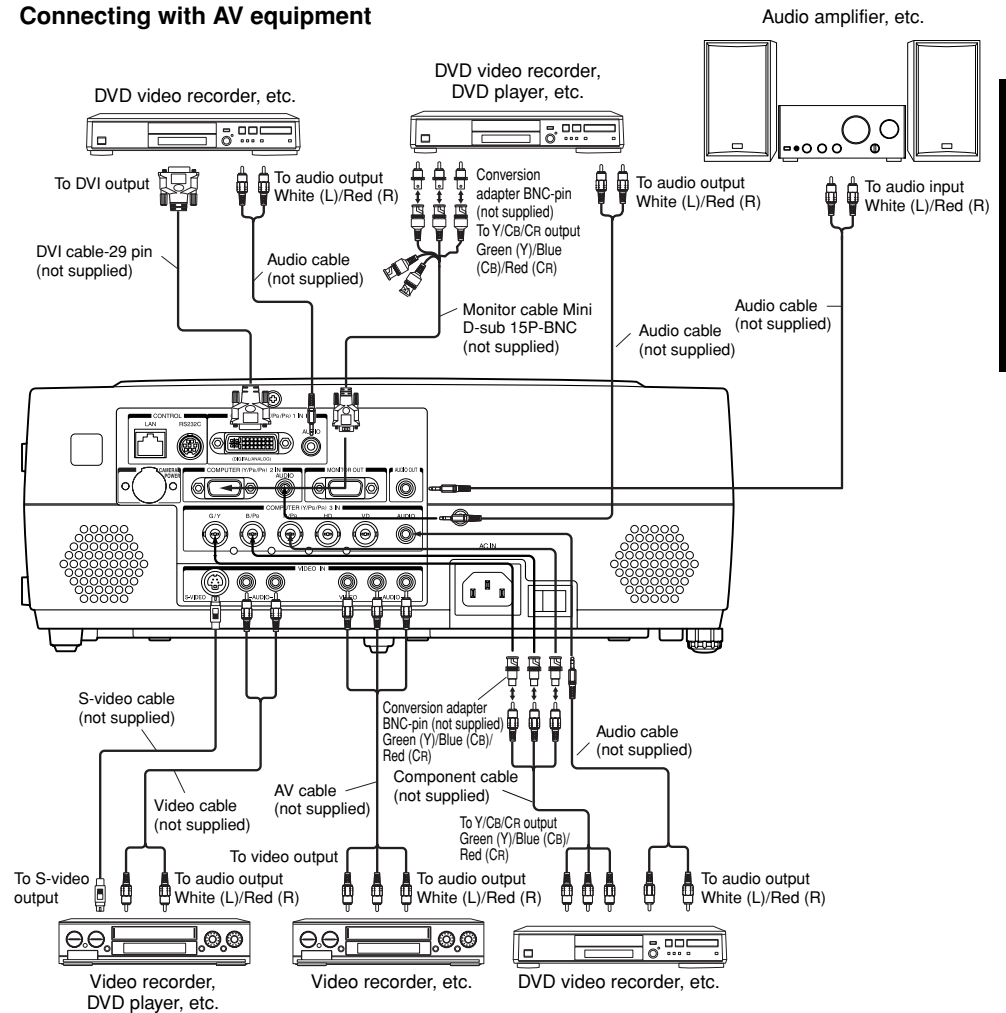

## Notes

- When an AUDIO OUT terminal is connected, sound is not output from the projector speaker.
- Output volume of AUDIO OUT terminal can be adjusted by the VOL button.

# Turning the power on and off

## ■ Connecting the power cord

- 1 Insert the power cord connector into the AC IN socket of the projector.
- 2 Insert the power cord plug into a wall or other power outlet.

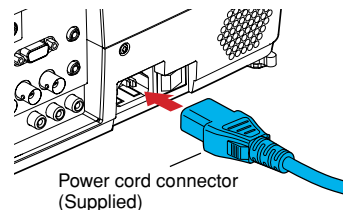

## ■ Removing the lens cover

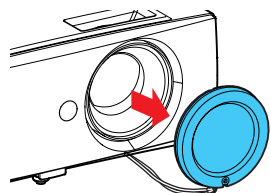

Be sure to remove the lens cover when the power is turned on. If it is left on, it could become deformed due to heat.

## ■ Turning the power on

- 1 Turn on the main power switch.

The ON/STANDBY indicator will change to orange, indicating standby mode.

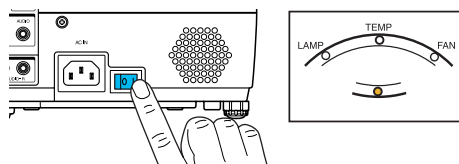

- 2 Press the ON/STANDBY button.

The power turns on with a beep sound (if the beep sound is set to [On]), and the following 3 green indicators light: ON/STANDBY, LAMP, and FAN. After a moment, the start-up screen appears.

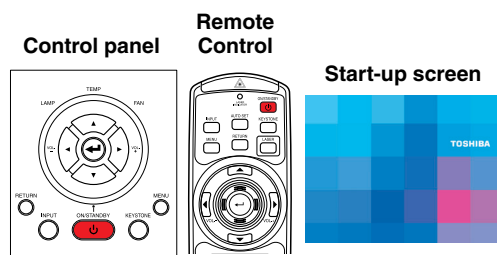

## ⚠ CAUTION

- Do not look into the lens while the lamp is on. The strong light from the lamp may cause damage to your eyes or sight.
- Do not block the air intake or exhaust. Doing so could cause a fire due to internal overheating.
- Do not place your hands, face, or other objects near the air exhaust. Doing so could cause burns, deform/break the object.

## ■ Notes

- The start-up screen will disappear after a moment. You can dismiss the start-up screen before this by performing any operation. You can also configure the start-up screen not to appear via the **Display setting** menu [p.41](#).

- The first time you use the projector after purchase, after the start-up screen disappears, the start menu is displayed [p.28](#).
- You can disable the beep sound in the **Display setting** menu [p.41](#).
- When **[Key lock]** is [On], the operation buttons of the projector do not work [p.44](#).
- When **[Password]** is [On], the start-up screen is displayed after the Password entry screen disappears [p.44](#).

## ■ Turning the power off

- 1 Press the ON/STANDBY button.

A message appears on the screen, confirming that you wish to shut off the power. This message will disappear after a moment. (This operation is no longer valid after the message disappears.)

- 2 Press the ON/STANDBY button again.

A beep sound is made (if the beep sound is set to [On]) and the screen turns off, but the internal cooling fan continues to operate for a short while. Then, the projector goes into standby mode.

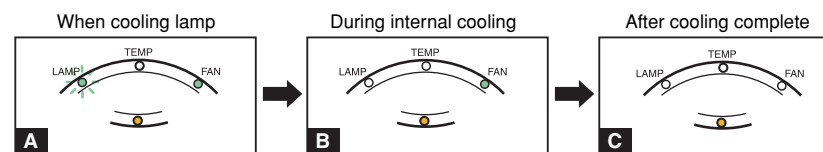

- A** During cooling, the LAMP indicator flashes. In this state, the power cannot be turned back on. If you are in a hurry, there is no problem with unplugging the power cord or turning off the main power switch in this state.
- B** After the LAMP indicator goes off, the FAN indicator keeps lighted and the cooling fan continues to operate for a short while, in order to expel excess internal heat.
- C** In standby mode

## ■ Note

- The projector consumes about 16W of power in standby. We recommend that you unplug the power cord or turn off the main power switch if you will not be using the projector for an extended period.

## ■ PRECAUTION

- If the power cord is unplugged before cooling is complete, give the lamp time (about 5 minutes) to cool before plugging it back in. If the lamp overheats, it may fail to light.

# Basic operations

## 1 Turn on the power.

Turn on the power by following the instructions in “Turning the power on” [p.26](#).

## 2 Select the language and the lamp power (When using the first time).

When the projector is used for the first time after purchase, the start menu for language (to display the menus and messages on the screen) and lamp power selection and configuration is displayed in English. (If the screen is out of focus, adjust it according to the step ⑥.)

### ① Use the ▲ or ▼ button to select the desired language and press the ⏻ button.

Message for setup confirmation is displayed in a selected language.

Then, the menu for lamp power selection and configuration is displayed. It is automatically set as Standard. To change the setting, follow the step ②.

### ② Use the ▲ or ▼ button to select the lamp power and press the ⏻ button.

The lamp power, if selected, will be toggled without pressing the ⏻ button. The display automatically disappears in a few seconds.

English	.....	English
Français	.....	French
Deutsch	.....	German
Italiano	.....	Italian
Español	.....	Spanish
Português	.....	Portuguese
Русский	.....	Russian
Svenska	.....	Swedish
Türkçe	.....	Turkish
Polski	.....	Polish
日本語	.....	Japanese
中文(简体字)	.....	Chinese (simplified)
中文(繁體字)	.....	Chinese (traditional)
한국어	.....	Korean

### Notes

- When the projector is turned on the next time, the start menu does not appear upon startup. However, if [Reset all] is executed from the **Default setting** menu [p.44](#), the start menu will be displayed the next time when the power is turned on.
- The language can also be set via the **Display setting** menu [p.41](#) and Lamp power via the **Default setting** menu [p.44](#).
- This owner's manual assumes that English has been selected.

## 3 Activate the connected device.

Turn on and start the connected device such as a computer.

## 4 Press the INPUT button.

An image of the connected equipment is projected.

Each time you press the **INPUT** button, it switches to the input of the connected equipment that is outputting video signals.

### Notes

- When [Auto input search] is set to [On] in the **Default setting** menu [p.44](#) (factory setting is [On]), the input is switched to the connected equipment that is outputting video signals each time you press the **INPUT** button [p.45](#).
- If no signal is being output from the connected equipment, pressing the **INPUT** button does not change the input and “There is no other input signal.” will appear.

## 5 Projector placement angle adjustments

The placement angle and the height of the projected image can be adjusted by the foot adjuster.

### ① Lift up the front of the projector to the desired angle, then press the foot adjuster release button.

The foot adjuster extends. Release the button to lock the position.

### ② To fine adjust the angle, twist the foot adjuster.

### ③ To adjust the horizontal angle, use the tilt adjuster.

To stow the foot adjuster, hold up the projector while pressing the foot adjuster release button, then slowly lower the projector.

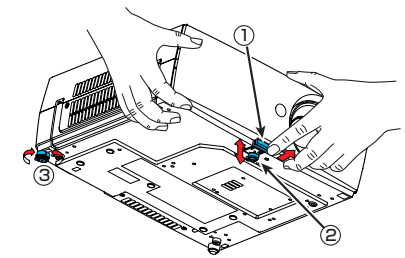

## 6 Adjusting the screen size and focus

### ① Use the zooming lever to adjust the screen size.

### ② Use the focusing lever to adjust the focus.

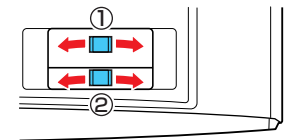

## 7 Adjusting the volume with the ◀ ▶ buttons

The speaker volume can be adjusted when an audio signal is being input.

### Notes

- Note that lamp characteristics may rarely cause the brightness to fluctuate slightly.
- A lamp is a consumable item. If used for extended periods, images will appear dark, and the lamp could burn out. This is characteristic of a lamp, and is not malfunction. (The lifetime of the lamp depends on conditions of use.)
- The DMD™ is made using extremely advanced technology, but there may be black spots (pixels that do not light) or bright spots (pixels that are constantly lit) on the panel. Please note that these are not malfunctions.
- Although this projector supports a wide range of RGB signals [p.56](#), any resolutions not supported by this projector (XGA) will be expanded or shrunk, which will affect image quality slightly. To view high-quality images, it is recommended that the computer's external output should be set to XGA resolution.
- With some models of computer having LCD displays or the like, displaying images simultaneously on the projector and the monitor's display may prevent the images from displaying properly. If this happens, turn off the computer's LCD display. For information on how to turn off the LCD display, see the owner's manual of your computer.
- If no signal is being input from the connected equipment or signal input is stopped while projecting, the “No signal” will appear.
- If a signal not supported by the projector is input, the “Unsupport signal” will appear.
- If an unavailable operation button is pressed, the ❌ icon will appear.

# Using handy features

## ■ Using auto setting (Only for analog input from computer)

This function sets up the projector to the optimum state such as sampling phase, frequency, screen position, and clamp for each type of the input signal by using simple operations.

### ● Press the remote control's AUTO SET button.

For computer input, the  icon will appear during processing. You can set as well by selecting [Auto setting] in the **Image adjustment** menu [p.39](#).

Remote Control



### ■ Notes

- The image may not be projected or auto adjustment/setting may not be performed correctly for input signals other than those supported by the projector [p.56](#), [p.57](#).
- If auto setting fails adjustment, adjust manually with the **Image adjustment** menu [p.39](#).

## ■ Correcting the keystone distortion

When the projector placement angle against the screen is changed while projecting the image, the picture will undergo keystone (trapezoidal) distortion.

This projector is capable of correcting this keystone distortion.

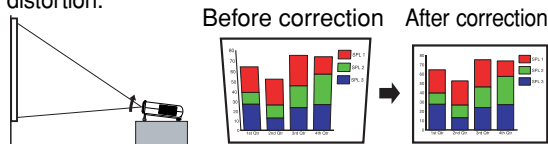





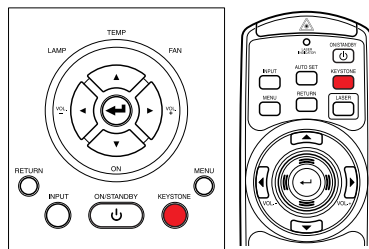



Control panel

Remote Control



### ① Press the KEYSTONE button.



The **Keystone** menu appears. By default, [Auto v-keystone] is selected.

Item	Description
 <b>Auto v-keystone</b>	Automatically corrects the vertical distortion. Press  .
 <b>V-keystone</b>	Screen shrinking at   Screen shrinking at bottom top
 <b>H-keystone</b>	Screen shrinking on   Screen shrinking on the left the right

## Adjusting vertical distortion [Auto]

### ② Press the button.

The keystone distortion is automatically corrected. The  icon appears during this correction.

When adjustment is finished, the **Keystone** menu appears again. For fine adjustment, select [V-keystone] by the  button and adjust image manually by the   buttons.

## Adjusting vertical distortion [Manual]

### ① Press the KEYSTONE button.

### ② Select [V-keystone] by the button.

### ③ Use the buttons for keystone adjustment.

## Adjusting horizontal distortion [Manual]

### ① Press the KEYSTONE button.

### ② Select [H-keystone] by the button.

### ③ Use the buttons for keystone adjustment.

When the adjustment is finished, the menu automatically disappears. The menu also disappears when the **KEYSTONE** or **RETURN** button is pressed.

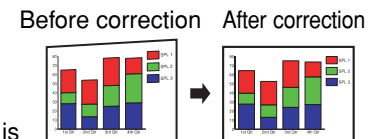

### ■ Notes

- To adjust both vertical and horizontal keystones, adjust vertical keystone at first.
- Depending on the amount of keystone adjustment and the content of images, some information may be lost, or the picture quality may suffer.

## ■ Resizing image

The projected image can be resized (zoomed in/out).

### ① Press the remote control's RESIZE button.

Each time you press the **RESIZE**  button, zoom ratio is up. You can keep pressing.

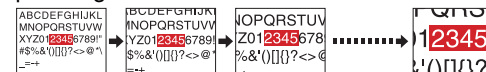

## Using handy features (Continued)

- 2 To zoom out, press the remote control's **RESIZE**  button.

Each time you press the **RESIZE**  button, zoom ratio is down. You can keep pressing.  
(However, the image cannot be smaller than the original size.)



- 3 To move the area to zoom in, use the , , , and  buttons.

You can keep pressing.



- 4 To reset the zoom, press the **RETURN** button.

The image is reset to the original size.

### Notes

- The  icon appears while resizing.
- Operating a function other than Mute will release resizing.
- As zooming is processed digitally, the image quality is degraded in larger zoom ratio.
- During resizing or moving the zooming area, the image may be distorted.

## ■ Cutting off the picture and sound temporarily (Mute)

When you want to project the images of another projector, overhead projector, etc. temporarily, this projector's images and sound can be turned off.

- Press the remote control's **MUTE** button.

The picture and sound are cut off. (The Mute function is released when pressing the **MUTE** button again.)

### Notes

- The  icon will appear while mute is in effect.
- Operating any other functions will also cancel the muting.

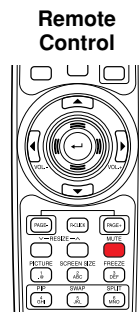
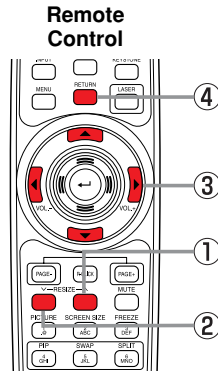

## ■ Changing picture mode

The projected image mode can be selected.

- Press the remote control's **PICTURE** button.

Pressing the button switches Bright/Standard/True color in turn.

### Note

- [Picture mode] of the **Image adjustment** menu has the same function [p.39](#).

## ■ Changing screen size

The screen size for the projected image can be changed.

- Press the remote control's **SCREEN SIZE** button.

Pressing the button switches Full/Thru/Wide in turn.

### Notes

- Thru display is available for computer-input images.
- [Screen size] of the **Display setting** menu has the same function [p.41](#).
- If you use this function on commercial video software, broadcast or cable-broadcasting except for the purpose of your private viewing and listening, it may infringe the copyright protected by the copyright laws.

## ■ Freezing the image (Freeze)

The image being projected can be frozen. This function is to be used to pause a video during a presentation, etc.

- Press the remote control's **FREEZE** button.

The picture pauses. (The Freeze function is released when pressing the **FREEZE** button again.)

### Notes

- The  icon will appear while freeze is in effect.
- Other operation will also release the freeze.
- Even if an image is frozen on the projector, the pictures are running on the video or other equipment.
- If you use this function on commercial video software, broadcast or cable-broadcasting except for the purpose of your private viewing and listening, it may infringe the copyright protected by the copyright laws.

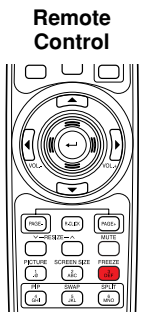
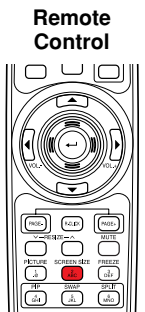
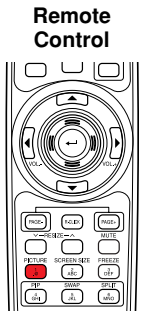



## Using handy features (Continued)

### ■ Display a sub screen (PIP function)

Another image can be added in smaller size (referred as sub screen in this manual) to the projected image (referred as main screen).

#### ● Press the remote control's PIP button.

A sub screen is displayed in the currently projected image (main screen).

To swap the main and sub screens, press the remote control's **SWAP** button.

To hide the sub screen, press the **PIP** button again.

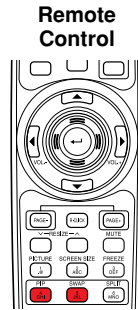
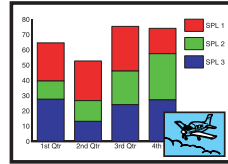

#### ■ Notes

- Sound of the main screen is output.
- Input select, display position and size of the sub screen can be changed in the **PIP** menu.
- Operating a function other than Mute, Freeze and volume control will release PIP mode.
- If you use this function on commercial video software, broadcast or cable-broadcasting except for the purpose of your private viewing and listening, it may infringe the copyright protected by the copyright laws.

### ■ Sub screen setting

Pressing the **MENU** button while the sub screen is displayed displays the **PIP** menu. This menu sets up the sub screen.

To hide the menu, press the **RETURN** button.

Item ▲ ▼	Description
<b>PIP size</b>	Sets the sub screen size. <b>Large</b> ◀ ▶ <b>Medium</b> ◀ ▶ <b>Small</b>
<b>PIP position</b>	Sets display position of the sub screen. ◻ ◀ ▶ ◻ ◀ ▶ ◻ ◀ ▶ ◻
<b>PIP input</b>	Selects the input source for the sub screen. When the main screen is input from computer or Y/PB/PR: Press ◀ or ▶, toggle the input with ▲ ▼ and fix selection with ◀. <b>Video/S-video</b> When the main screen is input from video or S-video: Press ◀ or ▶, toggle the input with ▲ ▼ and fix selection with ◀. <b>Computer (1) (Digital) / Y/PB/PR (1) (Digital) / Computer (1) (Analog) / Y/PB/PR (1) (Analog) / Computer (2) / Y/PB/PR (2) / Computer (3) / Y/PB/PR (3)</b>

### ■ Displaying two screens (SPLIT function)

This function displays two screens at a time.

#### ● Press the remote control's SPLIT button.

The projected image moves to the left (main screen), and a new image is displayed to the right (sub screen). To switch the sub and main screens, press the remote control's **SWAP** button.

To hide the sub screen, press the **SPLIT** button again.

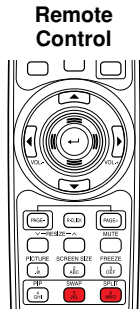

#### ■ Notes

- Sound of the main screen is output.
- Size of the screens and input source of the sub screen can be changed in the **SPLIT** menu.
- Compared with the main screen, the sub screen may suffer some slight image degradation.
- Operating a function other than Mute, Freeze and volume control will release the SPLIT mode.
- If you use this function on commercial video software, broadcast or cable-broadcasting except for the purpose of your private viewing and listening, it may infringe the copyright protected by the copyright laws.

### ■ SPLIT function setting

Pressing the **MENU** button while two screens are displayed displays the **SPLIT** menu. This menu sets up both screens.

To hide the menu, press the **RETURN** button.

Item ▲ ▼	Description
<b>Size</b>	Sets size of both screens. ◻ ◀ ▶ ◻
<b>Sub input</b>	Selects the input source for the sub screen. When the main screen is input from computer or Y/PB/PR: Press ◀ or ▶, toggle the input with ▲ ▼ and fix selection with ◀. <b>Video/S-video</b> When the main screen is input from video or S-video: Press ◀ or ▶, toggle the input with ▲ ▼ and fix selection with ◀. <b>Computer (1) (Digital) / Y/PB/PR (1) (Digital) / Computer (1) (Analog) / Y/PB/PR (1) (Analog) / Computer (2) / Y/PB/PR (2) / Computer (3) / Y/PB/PR (3)</b>

#### ■ Note

- To enlarge the screen fully, select **[Full]** for **[Size]**.

## Using handy features (Continued)

### ■ Screen combination of PIP and SPLIT functions

Group	Input signal
A	Computer (1) (Digital) / Y/PB/PR (1) (Digital)
	Computer (1) (Analog) / Y/PB/PR (1) (Analog)
	Computer (2) / Y/PB/PR (2)
	Computer (3) / Y/PB/PR (3)
B	Video
	S-video

#### ● For PIP function

A: Main screen, B: Sub screen  
A: Sub screen, B: Main screen

You cannot display two screens of the same group in the PIP mode.

#### ● For SPLIT function

A, B or B, A is available.

You cannot display two screens of the same group in the SPLIT mode.

### ■ Password function

When the password function is added and [Password] is set to [On], image projection requires an entry of the preset password at power-on.

To add the password function, perform the following procedure:

(The password function, once added, cannot be deleted. Set [Password] to [Off] if you do not want to use it after addition.)

① Set the projector to the operating status or the standby mode.

② Keep pressing the  button for about 10 seconds until a beep sounds.

The password function is added when the steps up to here have been completed. It is also added to the Default setting menu.

#### ● How to set password (from [Off] to [On])

① Select [Password] in the Default setting menu and press the  or  button.

The password setting confirmation screen is displayed. ([OK] or [Cancel])

② Select [OK] and press the  button.

The password entry screen is displayed.

③ Enter a four-digit number for the password using numeric keys of the remote control.

The input number appears as [\*\*\*\*].

④ Re-enter the same password for confirmation.

When the password is confirmed, the setting is complete and the password becomes [On].

If the password is wrong, repeat the procedure from step ②.

#### ● How to operate when password is [On]



① Turn on the power.

② The lamp lights and the password entry screen appears.

③ Enter the password using numeric keys of the remote control.

If the entered password is correct, the start-up screen appears and the projector goes into normal operation. If the password is wrong, a message appears to prompt you to re-enter the password. If you enter a wrong password for more than 5 times, the projector will automatically power off and enter standby mode.

#### ● How to cancel password (from [On] to [Off])

① Select [Password] in the Default setting menu and press the  or  button.

The password entry screen is displayed.

② Enter the password using numeric keys of the remote control.

③ The password cancel confirmation screen is displayed. ([OK] or [Cancel])

④ Select [OK] and press the  button.

The [Password] is canceled and becomes [Off].

#### ■ Note

- The password entry screen appears when the power is turned back on only after the main power switch is turned off or the power cord is unplugged.

**If you forgot the password, please inquire your dealer.**





## Using the menus (Continued)

Item ▲ ▼	Description	Digital (DVI)		Analog (D-SUB)(BNC)		Video	S-video
		RGB	Y/Pb/Pr	RGB	Y/Pb/Pr		
<b>V-position</b>	Adjust the vertical position of the image. Move down ◀ ▶ Move up	No	No	Yes	No	No	No
<b>Clamp 1</b>	Adjusts the clamp pulse position. Lower ▶ Higher	No	No	Yes	No	No	No
<b>Clamp 2</b>	Adjusts the clamp pulse width. Narrower ▶ Wider	No	No	Yes	No	No	No
<b>Equalizer</b>	Reduce noise on the screen. Adjust with ▶ ◀.	Yes	Yes	No	No	No	No

\*1: [Tint] and [NTSC mode] can be displayed and adjusted only when the video signal is set to [NTSC] and [NTSC4.43].

\*2: [Noise reduction] may not work depending on signal type.

\*3: [NTSC mode] is set to JAPAN when the language is set to Japanese. It is set to US for other languages.

## ■ The display setting menu

Use this menu to set screen display-related items.

(The items in gray color cannot be set with the current input selection.)

Item ▲ ▼	Description
<b>Screen size</b>	 (Full): Display with 1024 × 768 dot resolution (Thru): Display with sampling resolution (for computer input only) (Wide): Wide-screen display
<b>Language</b>	Select one of the languages below to use for displaying the menu and messages [◀ or ▶: Enter setting mode] → [▲ ▼: Selection] → [Apply: ↵] <b>English/Français/Deutsch/Italiano/Español/Português/Русский/Svenska/Türkçe/Polksi/日本語/中文(簡体字)/中文(繁体字)/한국어</b>
<b>Background</b>	Screen to display when there is no input signal [◀ or ▶: Enter setting mode] → [▲ ▼: Selection] → [Apply: ↵] <b>Logo/Blue/None</b>
<b>Icon</b>	Display icons as function guides <b>On ▶ Off</b>
<b>Beep</b>	Sound a beep when operation is done. <b>On ▶ Off</b>
<b>Start-up screen</b>	Display start-up screen when power is turned on <b>On ▶ Off</b>
<b>User logo</b>	Display a logo customized by the user for the start-up screen or when there is no input signal. [◀ or ▶: Enter setting mode] → [▲ ▼: Selection]
	<b>Logo registration</b> Press ◀ to display the registration menu.
	<b>Display style</b>
	<b>Background</b> <b>Black ▶ Blue ▶ White</b>
	<b>Logo confirmation</b> Press ◀.
	<b>Reset logo</b> <b>Yes ▶ No</b>

### ● Detailed description

#### [Screen size]

- If “Thru” is selected for [Screen size], portions exceeding the native resolution (1024 × 768 pixels) will not appear on the screen. Note that for RGB signals with clock frequency 140MHz or lower, all input pixel signals are sampled. However, if the clock speed is higher than this, the RGB pixel signal is thinned before sampling.
- If you use the screen size setting function on commercial video software, broadcast or cable-broadcasting programs to display images with the varying aspect ratio except for the purpose of your private viewing and listening, it may infringe the copyright protected by the copyright laws.

## Using the menus (Continued)

### [Background]

- TOSHIBA is set for [Logo] by factory setting.
- If user's logo has been registered, it is displayed when [Logo] is set for background.

### [Start-up screen]





If user's logo has been registered and this setting is [On], the logo is displayed at start-up.

### [User logo]

Registers a part of the image that is input from computer and displays it as a logo at start-up and when no signal is input.

### <Logo registration>

#### ● How to register user logo



- 1 Select [User logo] in the Display setting menu, and press the  or  button.
- 2 Select <Logo registration> from the displayed menu list and press the  button.
- 3 The registration area is displayed for confirmation. Select [OK] or [Cancel] and press the  button.
  - If the picture does not fall within the area, operate the computer to scroll the screen.
- 4 Press the  button to register.
- 5 Registration starts.
  - A message is displayed while registration is in process.

#### ■ Notes

- You can register a logo from computer input only.
- The area that can be registered is 512 × 384 dots at the center of the screen. To register a company logo, prepare the image within the limit.
- Only one logo can be registered. When a new image is registered, the old one is erased.
- The time needed to register or display the image varies depending on the data size.
- If you use this function on commercial video software, broadcast or cable-broadcasting except for the purpose of your private viewing and listening, it may infringe the copyright protected by the copyright laws.

### <Display style>

Select the size of the registered logo (except during the PIP and SPLIT modes).

- : Displays the registered image in original size at center of the screen.
- : Displays the registered image by enlarging fully in the screen.  
(As processed digitally, the image quality is degraded.)

### <Background>

Sets background color when [Center] is selected for the logo display mode.

### <Logo confirmation>

You can preview the registered logo.

### <Reset logo>

You can reset the registered logo, display style and background to the factory setting. (The logo set for the start-up screen and background is reset.)

# Using the menus (Continued)

## ■ The default setting menu

This menu shows placement status and other settings.

Item ▲▼	Description
<b>Projection mode</b>	Sets projection mode in accordance with Placement Style. <a href="#">p.22</a> (Standard)  (Rear)  (Ceiling)  (Rear ceiling)
<b>Blackboard mode</b>	When projecting on a non-screen surface, select a color in accordance with the projecting surface. Press  and switch with  and . <b>Off/Green/Black/Brown/Blue/Beige</b>
<b>No signal power off</b>	Set the time to wait for the power to be turned off after the last operation is made with no input signal. Press  and switch with  and . <b>Off (not turned off)/1 min./5 min./10 min./30 min./60 min.</b>
<b>Auto input search</b>	Set whether the input with signals is only selected or not. <b>On   Off</b>
<b>Power on</b>	Sets whether to turn on the power when the <b>ON/STANDBY</b> button is pressed (Manual), or when the main power switch is turned on (Auto). <b>Manual   Auto</b>
<b>Lamp power</b>	Sets the lamp power. <b>Low   Standard</b>
<b>Fan mode</b>	Sets the cooling fan speed. <b>Standard   High</b>
<b>Remote control</b>	When two or more projectors are used and controlled by the remote control respectively, this menu sets the code for the projector and the remote control. [ or  : Enter setting mode] → [  : Select item] → [  : Select from 1, 2, 3, 4] → [ : Confirm] → [  : Select OK to end] Press [ <b>Cancel</b> ] to return.
<b>Key lock</b>	Lock the control panel buttons. [ or  : Enter setting mode] → [  : Select item] → [  : Select <b>On/Off</b> ] → [ : Confirm] → [  : Select OK to end] Press [ <b>Cancel</b> ] to return.
<b>Reset all</b>	Press . (The password and user logo are not reset.) Resets all adjustments and settings to their factory settings. <b>Yes   No</b>
<b>Password</b>	Password function <a href="#">p.36</a> <b>Off   On</b> When [ <b>Password</b> ] is [ <b>On</b> ], the Password Setting screen is displayed.

### ● Detailed description

#### [Blackboard mode]

Projects the image in colors more like projecting on a screen.

#### ■ Note

- The projected image may differ depending on the type, color, and material of the blackboard and wall even if the selected color is the same as the projected screen.

### [Auto input search]

**[On]:** Automatically searches the signals that can be projected, and switches input from the connected device that outputs the signals each time the **INPUT** button is pressed. The input from the connected device that outputs no signals is skipped.

**[Off]:** Displays the **Input select** menu.

Toggle with buttons and press button. (The input without signals can be selected.)

### Input select menu

Input select	
<input checked="" type="radio"/>	Computer (1) (Digital)
<input type="radio"/>	Y/Pb/Pr (1) (Digital)
<input type="radio"/>	Computer (1) (Analog)
<input type="radio"/>	Y/Pb/Pr (1) (Analog)
<input checked="" type="radio"/>	Computer (2)
<input type="radio"/>	Y/Pb/Pr (2)
<input type="radio"/>	Computer (3)
<input type="radio"/>	Y/Pb/Pr (3)
<input checked="" type="radio"/>	Video
<input type="radio"/>	S-video

●/○ shows whether signal is input or not.

### [Power on]

Note that if [**Power on**] is set to [**Auto**], then if the **main power switch** is ON when power is restored after a power outage, the projector will come on.

### [Lamp power]

When [**Lamp power**] is set to [**Low**], the screen becomes a little darker, but the cooling fan noise gets quieter.

### [Fan mode]

Setting [**Fan mode**] to [**High**] increases the cooling fan speed. Set this option to use the projector, for example, at high altitude (over 1,500 meters above sea level).

### [Remote control]

Sets a remote control code from 4 types. You can set each code respectively for up to 4 projectors. The factory setting is [1].

To switch codes, set the same code for the projector and the remote control. A remote control code is applied after the setting is done.

- You cannot operate the remote control if the codes of the projector and the remote control do not match.

### ● Remote control code setting for remote control

Remove the battery cover and set the same **remote control code switch** as the projector. [p.16](#) (Use a screwdriver with thin tip to set.)



### [Key lock]

Protect from operating errors by locking on the control panel buttons of the projector. (The remote control operations are available.)

Control panel operations are locked after the setting is done.

- To release the key lock, press the control panel's **RETURN** button for 10 seconds. The key lock is released with a beep sound.

# Using the menus (Continued)

## ■ The control setting menu

This menu sets items regarding wired LAN.

By this setting, you can transmit operation status messages from the projector to the specified E-mail address.

Item	Description
<b>Wired LAN</b>	[  : Wired LAN setting ] → [  : Select item ]
	<b>Projector name:</b> Enter a character string (0 to 64 characters) using numeric keys of the remote control.
	<b>DHCP: Use</b> <b>Not use</b>
	<b>IP address:</b> Enter a character string using numeric keys of the remote control.
	<b>Subnet mask:</b> Enter a character string using numeric keys of the remote control.
	<b>Gateway:</b> Enter a character string using numeric keys of the remote control.
	<b>Confirm:</b> [OK   Cancel] →
<b>Email</b>	[  : E-mail setting ] → [  : Select item ]
	<b>Status notification:</b> On <b>Off</b>
	<b>SMTP server:</b> Enter a character string using numeric keys of the remote control.
	<b>Port number:</b> Enter a character string using numeric keys of the remote control.
	<b>Destination address:</b> Enter a character string using numeric keys of the remote control.
	<b>Confirm:</b> [OK   Cancel] →
<b>PJLink</b>	[  : PJLink setting ] → [  : Select item ]
	<b>PJLink authentication:</b> On <b>Off</b>
	<b>Password:</b> Enter a desired character string (1 to 32 characters) using numeric keys of the remote control.
	<b>Confirm:</b> [OK   Cancel] →

### ● Detailed description

#### [Wired LAN]

<**Projector name**>: Setting a projector name helps you identify each of the projectors that are connected to the network.

- You cannot set a projector name starting with ERR.

<**DHCP**>: When <**DHCP**> is set to [Use], an IP address is automatically assigned to the projector by a DHCP server. In case of a network that an IP address cannot be assigned automatically, set <**DHCP**> to [Not use].

When <**DHCP**> is set to [Not use], ask your network administrator for **IP address**, **subnet mask**, and **gateway**, then set the following items manually:

<**IP address**>: This is a unique number assigned for a terminal to connect to a network. The format is a quartet of 3-digit decimal number. (Example: 111.112.xxx.xxx)

<**Subnet mask**>: For dividing the network, the subnet mask determines the range of an IP address assigned to a terminal. (Example: 255.255.xxx.xxx)

<**Gateway**>: Gateway specifies a network device like a router when accessing a server outside the network. It is identified by an IP address. (Example: 111.112.xxx.xxx)

#### [Email]

<**Status notification**>: Sends alarm information to the specified E-mail address when an error such as lamp blowout occurs.

<**SMTP server**>: Set an IP address of the SMTP server.

<**Port number**>: Enter a port number of the SMTP server.

<**Destination address**>: Enter within 60 characters. (Example: xxx@xxx.xxx)

#### [PJLink]

<**PJLink authentication**>: Set whether or not to authenticate the user by password when the projector is accessed via the **PJLink**-compliant Software Application. (Set [On] or [Off].)

<**Password**>: Enter a password for confirmation when the above <**PJLink authentication**> is set to [On].

### ■ Precautions

- When purchased, <**PJLink authentication**> is set to [Off] and <**Password**> is not set by factory setting. You are recommended to make authentication setting as soon as possible.
- If you forget a password, set it again.

### ● Character entry

Enter characters using numeric keys of the remote control.

The character is entered with a beep sound if the beep sound is set to [On].

Character entry mode		
Remote control button	Items using characters, numbers, and symbols (e.g., projector name and destination address)	Number only
	"1" "." "@" "-" "_"	"1"
	"2" "A" "B" "C" "a" "b" "c"	"2"
	"3" "D" "E" "F" "d" "e" "f"	"3"
	"4" "G" "H" "I" "g" "h" "i"	"4"
	"5" "J" "K" "L" "j" "k" "l"	"5"
	"6" "M" "N" "O" "m" "n" "o"	"6"
	"7" "P" "Q" "R" "S" "p" "q" "r" "s"	"7"
	"8" "T" "U" "V" "t" "u" "v"	"8"
	"9" "W" "X" "Y" "Z" "w" "x" "y" "z"	"9"
	"0" "space!"#\$%&'()*+,-./:;<=>?@[\\]^_`{ }~"	"0"
	Deletes one character.	Deletes one character.

## Using the menus (Continued)

### ■ Displaying Information (Status display)

This displays information about the input signal, lamp use time, LAN connection status, etc.

“Yes”: displayed, “No”: not displayed

Item	Description	Computer	Y/Pb/Pr	Video	S-video
<b>Projector</b>					
Input	Input source name	Yes	Yes	Yes	Yes
Mode name	RGB input mode <sup>[Note 1]</sup>	Yes	No	No	No
Resolution	Resolution (in dots)	Yes	No	No	No
Frequency	Sync frequency	Yes	No	No	No
Sync	Sync signal polarity <sup>[Note 2]</sup>	Yes	No	No	No
Signal format	Y/Pb/Pr signal format	No	Yes	No	No
Video mode	Color method of video signal	No	No	Yes	Yes
Lamp time	Time of lamp use <sup>[Note 3]</sup>	Yes	Yes	Yes	Yes
Lamp reset count	The count for lamp replacement	Yes	Yes	Yes	Yes
Total time	The total time that this projector is used.	Yes	Yes	Yes	Yes
Version	Firmware version <sup>[Note 4]</sup>	Yes	Yes	Yes	Yes
<b>Wired LAN</b>					
Connection status	Displays connection status of LAN.	Yes	Yes	Yes	Yes
IP address	Displays the IP address.	Yes	Yes	Yes	Yes
Subnet mask	Displays numeric value of subnet mask.	Yes	Yes	Yes	Yes
Gateway	Displays numeric value of gateway.	Yes	Yes	Yes	Yes
MAC address	Displays MAC address of the projector. <sup>[Note 5]</sup>	Yes	Yes	Yes	Yes
PJLink class	PJLink version	Yes	Yes	Yes	Yes

#### Notes

- 1: The mode of supported RGB signals [p.56](#) is shown.
- 2: Sync signal polarity shown as P (positive) or N (negative) for [H/V].
- 3: Displays [**Lamp time**] as a measure of when the lamp should be replaced. (Cannot be used as a counter of guaranteed lamp time.) When the displayed time approaches 1,500 hours, consult with a store about getting a TLPLW13 replacement lamp (sold separately) prepared.
- 4: [**Version**] shows the version of the projector's internal control program. This version is referred to for customer service, etc.
- 5: In case that "-----" appears for MAC address, please contact your dealer.

#### ■ Note

- The displayed information will not be refreshed if the status changes. To refresh the information, dismiss the display, then display it again. The information regarding wired LAN is refreshed every time it is displayed.

## About lamp

The product's light source is a mercury lamp that lights at increased internal pressure. Be sure to fully understand the following characteristics of the lamp and handle it with extreme care.

- The lamp may burst with a loud noise due to impact or deterioration, or fail to light at the expiration of its life.
- How long it takes before the lamp bursts or the life expires may vary greatly by lamp. Some may burst shortly after first use.
- Burst is likely to happen if the lamp is used after the replacement period has elapsed.
- When the lamp bursts, the broken pieces of glass may get inside the product or be released outside from the openings for ventilation.
- When the lamp bursts, a slight amount of mercury gas enclosed in the lamp along with glass dust may be released from the openings for ventilation.

### ■ Immediately replace the lamp when a sign appears on the screen.

- When the replacement time approaches, a message will appear on the screen.
- The risk of burst will increase if the lamp is continuously used without being replaced.
- Frequently check the used hours and prepare spares when the replacement time approaches. (Refer to “Status display”. [p.48](#))

### ■ When the lamp is broken

- If glass components, including a lamp and a lens, should break, handle the broken pieces with care to avoid injury and contact your dealer for repair service.
- In the event of lamp burst, unplug the product from the wall outlet, leave and completely ventilate the room. Then, thoroughly clean the area around the projector and discard any edible items placed in that area.
- When the lamp bursts, consult a doctor if glass dust or mercury gas gets into your eyes or you breathe it.

## Lamp replacement

A lamp is consumable supplies. If used for extended periods, images will appear dark, and the lamp could burn out. This is characteristic of a lamp, and is not malfunction. (The lifetime of the lamp depends on condition of use.) If this happens, replace it with a new one.

### ⚠ WARNING

- **If the projector is mounted on the ceiling, it is recommended to use your Toshiba dealership when the lamp has to be exchanged.**  
Uncovering the lamp while the projector is mounted on a ceiling may lead to a danger of damage from falling pieces of glass if the lamp is broken. Besides, working at high elevations can also be hazardous. Do not attempt to replace the lamp by yourself.
- When replacing, always use lamp “TLPLW13” (sold separately).

### ⚠ CAUTION

- If you have been using the projector, the lamp will be very hot, and may cause burn injuries. Wait for the lamp to cool (for longer than 1 hour) before replacing it.
- If the lamp should break, please handle with care to avoid injury due to broken pieces and contact your dealer for repair service.

## Lamp replacement (Continued)

### 1 Unplug power cord.

### 2 Wait until lamp is sufficiently cooled.

Wait for at least 1 hour.

### 3 Remove the outer lamp cover.

Loosen the two screws, raise the outer lamp cover with your fingers as shown to remove the outer lamp cover. Use care to avoid any damage to nails and/or tip of your finger(s). If you have any difficulty in removal, you can use a screwdriver or any other smaller tool for your convenience.

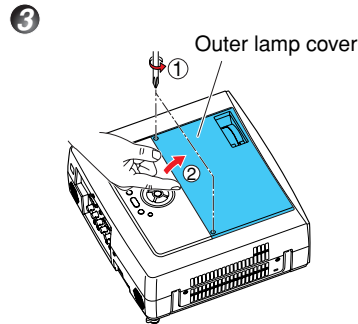

### 4 Remove the inner lamp cover.

Loosen the screw to remove the inner lamp cover.

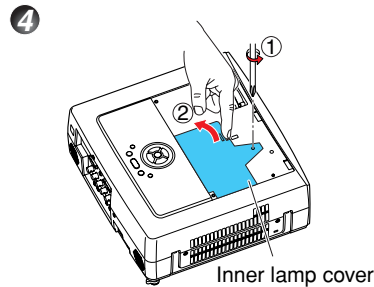

### 5 Pull out the lamp.

Loosen the three lamp locking screws, pull up the handle, and press the tab to remove the lamp.

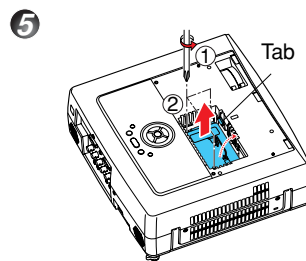

### 6 Mount the new lamp.

Align the orientation, press down the new lamp until the bottom is reached, and lock in place using the three lamp locking screws.

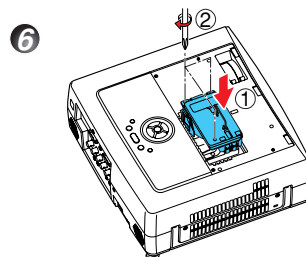

### 7 Replace the inner lamp cover.

Tighten the screw loosened in step 4 until the inner lamp cover is no longer loose.



### 8 Replace the outer lamp cover.

Align the cover, and press it in, then tighten the screws loosened in step 3 until the outer lamp cover is no longer loose. (Be sure to replace the outer lamp cover.)

### 9 Reset the lamp timer.

See the lamp's manual for instructions on resetting the lamp timer.

### Notes and Precautions

- The **Lamp time** item in the **Status display** menu indicates the time of lamp use (as a rough guide). [p.48](#)
- It is recommended that the lamp be replaced after 1,500 hours of use. When [Lamp time] reaches 1,500 hours, the  icon and a message will appear with a beep sound. (After 1,500 hours, they will appear when the power is on at the first time every 100 hours.) This display disappears when you press the  button.
- Attach the outer lamp cover correctly so that it is not loose. If it is not attached correctly, the projector may fail to be powered on or the lamp may fail to come on.
- Always replace the lamp with a new one.
- The lamp is made out of glass. Do not touch the glass surface with your bare hands, bang it, or scratch it. (Dirt, jolts, scratches and the like could break the lamp.)

### Used Lamps

This projector's lamps contain trace amounts of environmentally harmful inorganic mercury. Be careful not to break used lamps, and dispose of them in accordance with local regulations.



# Lens and main unit cleaning

## ⚠ WARNING

- Request cleaning and maintenance of a ceiling-mounted unit from your projector dealership. Attempting to clean/replace the lamp at a high site by yourself may cause you to fall down, thus resulting in injury.

## ■ Lens cleaning

- Clean the lens with a commercially available blower and/or lens cleaner.
- The lens is easily scratched, so do not rub it with hard objects, or strike it.

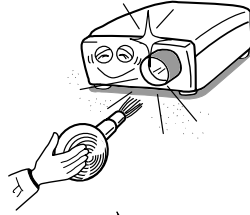

## ■ Main unit cleaning

- Clean the main unit after unplugging the power cord.
- Wipe dirt off the main unit gently with a soft cloth.
- Do not wipe the main unit with a damp cloth. Doing so may allow water to get inside, resulting in an electric shock or failure.
- Do not use benzene, thinner and the like as they may deform or discolor the unit or damage the paint surface.
- When using a chemically treated cloth, follow the precautions included with the cloth.

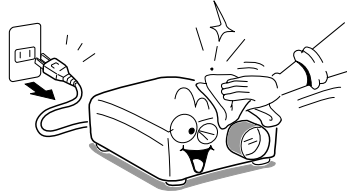

# Trouble indications

The indicator lights and a beep sound inform you of internal abnormalities.

	<p><b>No power</b></p> <p>⇒ Problem with projector</p> <ul style="list-style-type: none"> <li>• Unplug the power cord, and contact your dealer.</li> </ul>
	<p><b>Lamp went out during use, or won't come on</b></p> <p>⇒ Lamp temperature is high so that it is difficult to turn on, the lifetime of the lamp has ended or the projector is malfunctioning.</p> <ul style="list-style-type: none"> <li>• Unplug the power cord and wait for a short while, then turn the power back on.</li> <li>• If a lamp burns out, replace it with a new one.</li> </ul> <p>※ After approx. one minute of abnormal display, the projector returns to the standby state waiting for internal cool down.</p>
	<p><b>Power went out during use</b></p> <p>⇒ Internal overheating, or the outside temperature is too high.</p> <ul style="list-style-type: none"> <li>• Place the projector so that the air intake and exhaust are not blocked.</li> <li>• Unplug the power cord and wait for a short while, then turn the power back on.</li> </ul> <p>※ The  icon will appear before the power goes out.</p> <p>※ After approx. one minute of abnormal display, the projector returns to the standby state waiting for internal cool down.</p>
	<p><b>Power went out during use</b></p> <p>⇒ Problem with internal cooling fan.</p> <ul style="list-style-type: none"> <li>• Unplug the power cord, and contact your dealer.</li> </ul> <p>※ The  icon will appear before the power goes out.</p> <p>※ After approx. one minute of abnormal display, the projector returns to the standby state waiting for internal cool down.</p>
	<p><b>Power went out during use, or power won't come on</b></p> <p>⇒ The lamp cover is not properly attached.</p> <ul style="list-style-type: none"> <li>• Unplug the power cord, and reattach the lamp cover. <a href="#">p.51</a></li> </ul> <p>※ After approx. one minute of abnormal display, the projector returns to the standby state waiting for internal cool down.</p>
	<p><b>Power went out during use</b></p> <p>⇒ Problem inside the projector.</p> <ul style="list-style-type: none"> <li>• Unplug the power cord and wait for a short while, then turn the power back on.</li> <li>• If the above action will not clear the problem, unplug the power cord, and contact your dealer.</li> </ul> <p>※ The  icon will appear before the power goes out.</p> <p>※ After approx. one minute of abnormal display, the projector returns to the standby state waiting for internal cool down.</p>

# Before calling service personnel

If you think something is wrong, check the followings before contacting customer service. Please see "Trouble indications" p.53 as well.

If This Happens	Check
<b>No power</b>	<ul style="list-style-type: none"> <li>Is the power cord plugged in? Is it connected to the projector?</li> <li>Is the main power switch turned on? p.26</li> <li>Is the outer lamp cover attached properly? p.50</li> </ul>
<b>Power goes out during use</b>	<ul style="list-style-type: none"> <li>Is the ambient temperature high? p.53</li> <li>Is the air intake or air exhaust blocked? p.53</li> </ul>
<b>No picture</b>	<ul style="list-style-type: none"> <li>Is the projector turned on? (When [Auto input search] is [Off]) p.45</li> <li>Is the mute function on? p.32</li> <li>Is the brightness setting minimized? p.39</li> <li>Are the connections set up correctly? p.24</li> <li>Are all the connected devices functioning properly?</li> </ul>
<b>No audio</b>	<ul style="list-style-type: none"> <li>Is the mute function on? p.32</li> <li>Is the volume setting minimized? p.29</li> <li>Are the connections set up correctly? p.24</li> <li>Are all the connected devices functioning properly?</li> </ul>
<b>Picture not displayed correctly</b>	<ul style="list-style-type: none"> <li>Is the input signal supported by the projector? p.56, p.57</li> <li>Is there something generating an abnormal video signal, for instance the video tape?</li> </ul>
<b>Picture blurred Part of picture out of focus</b>	<ul style="list-style-type: none"> <li>Is the lens dirty? p.52</li> <li>Is the lens focus adjusted optimally? p.29</li> <li>Is the projection distance within the projector's supported range? p.23</li> <li>Is the projector's screen placement angle tilted too far? p.23</li> <li>Are the sharpness or sampling phase adjustments off? p.39</li> </ul>
<b>Image is dark</b>	<ul style="list-style-type: none"> <li>Are the brightness or contrast adjustments off? p.39</li> <li>Is the lamp nearing the end of its service life? p.48</li> </ul>
<b>Colors too light Bad shading</b>	<ul style="list-style-type: none"> <li>Are the color, tint, R-level, G-level, or B-level adjustments off? p.39</li> <li>Is the screen dirty?</li> <li>Is the blackboard mode set properly? p.44</li> <li>Is the lamp nearing the end of its service life? p.48</li> </ul>
<b>Control panel key doesn't work</b>	<ul style="list-style-type: none"> <li>Is the key lock function on? p.44</li> </ul>
<b>Remote control doesn't work</b>	<ul style="list-style-type: none"> <li>Is the remote control ON/OFF switch set off? p.20</li> <li>Is the remote control code identical with the projector's code? p.45</li> <li>Are the remote control's batteries drained?</li> <li>Are the batteries inserted into the remote control correctly? p.20</li> <li>Is the remote control being used within the effective range? p.20</li> <li>Are there any obstructions between the remote control and projector?</li> <li>Are there any fluorescent or other bright lights shining at the projector's infrared remote sensor?</li> </ul>

# Specifications

## List of general specifications

Item	Specification	
Consumption Power	390 W	
Weight	4.9 kg	
External Dimensions (including protruding parts)	340 × 115 × 314 mm (W × H × D)	
Cabinet material	PC+ABS resin and ABS resin	
Conditions for usage environment	Temp: 5°C to 35°C; relative humidity: 30% to 70%	
Display pixels	1 chip DMD™	
Picture elements	786,432 pixels (1024H × 768V)	
Lens	Zoom lens F=2.4-2.6 f=23-27.6 mm	
Lamp	High-pressure mercury lamp (300 W)	
Projection screen size	33-300 inches	
Projection distance	1.29-12.10m	
Speaker	4 W + 4 W (stereo)	
Connection terminal	CONTROL terminal	LAN: 10BASE-T/100BASE-TX RS-232C: Mini DIN 8 pin
	COMPUTER(Y/PB/PR) 1 IN terminal	DVI-I: Analog RGB / Digital RGB / Y/PB/PR (dual use) AUDIO: 3.5mm dia. stereo mini-jack, 1.5 V (rms)
	COMPUTER(Y/PB/PR) 2 IN terminal	Mini D sub 15 pin Analog RGB / Y/PB/PR (dual use) AUDIO: 3.5mm dia. stereo mini-jack, 1.5 V (rms), 22 kΩ or more
	COMPUTER(Y/PB/PR) 3 IN terminal	G/Y: BNC Jack G: 0.7 V (p-p), 75Ω, Y: 1 V (p-p), 75Ω B/PB: BNC Jack 0.7 V (p-p), 75Ω R/PR: BNC Jack 0.7 V (p-p), 75Ω HD (Horizontal sync signal): BNC Jack TTL level (Pos/neg polarity) VD (Vertical sync signal): BNC Jack TTL level (Pos/neg polarity) AUDIO: 3.5mm dia. stereo mini-jack, 1.5 V (rms), 22 kΩ or more
	VIDEO IN terminal	S-VIDEO: Mini DIN 4 pin AUDIO (L/R): RCA Pin Jack × 2, 1.5 V (rms), 22 kΩ or more VIDEO: RCA Pin Jack, 1 V (p-p), 75Ω AUDIO (L/R): RCA Pin Jack × 2, 1.5 V (rms), 22 kΩ or more
	MONITOR OUT terminal	Mini D sub 15 pin RGB / Y/PB/PR (dual use)
	AUDIO OUT terminal	3.5mm dia. stereo mini-jack, 1.5 V (rms), 22 kΩ or more

## Notes

- This model complies with the above specifications.
- Designs and specifications are subject to change without notice.
- This model may not be compatible with features and/or specifications that may be added in the future.

## Separately sold product

Replacement Lamp Model TLPLW13



## Specifications (Continued)

### List of supported signals (RGB signals)

This projector supports the following RGB signals. Note, however, that depending on the computer model, the screen may show flicker or streaking. Please adjust the projector if this happens.

Resolution	Mode	Refresh rate (Hz)	H-frequency (kHz)	Clock (MHz)
720 x 400	720x400_85	85.039	37.927	35.500
640 x 480	VGA_60	59.940	31.469	25.175
	VGA_72	72.809	37.861	31.500
	VGA_75	75.000	37.500	31.500
	VGA_85	85.008	43.269	36.000
800 x 600	SVGA_56	56.250	35.156	36.000
	SVGA_60	60.317	37.879	40.000
	SVGA_72	72.188	48.077	50.000
	SVGA_75	75.000	46.875	49.500
	SVGA_85	85.061	53.674	56.250
832 x 624	MAC16"	74.550	49.725	57.283
1024 x 768	XGA_60	60.004	48.363	65.000
	XGA_70	70.069	56.476	75.000
	XGA_75	75.029	60.023	78.750
	XGA_85	84.997	68.667	94.500
	MAC19"	74.700	60.134	79.857
1152 x 864	SXGA1_75	75.000	67.500	108.000
1280 x 960	QuadVGA_60	60.000	60.000	108.000
	QuadVGA_85	85.002	85.938	148.500
1280 x 1024	SXGA3_60	60.020	63.981	108.000
	SXGA3_75	75.025	79.976	135.000
	SXGA3_85	85.024	91.146	157.500
* 1400 x 1050	SXGA+	59.978	65.317	121.750
* 1600 x 1200	UXGA_60	60.000	75.000	162.000
	UXGA_65	65.000	81.250	175.500
	UXGA_70	70.000	87.500	189.000
	UXGA_75	75.000	93.750	202.500
	UXGA_85	85.000	106.250	229.500

\* Depending on the model of computer, the image may not be displayed properly with the DVI input.

### Note

- Signals whose resolution exceeds the native resolution (1024 x 768 pixels) will be compressed. For this reason, some information may be lost, or image quality may be affected.

### List of supported signals (Y/P<sub>B</sub>/P<sub>R</sub> signals)

Signal format	fh(kHz)	fv(Hz)
* 480i(525i)@60Hz	15.73	59.94
480p(525p)@60Hz	31.47	59.94
* 576i(625i)@50Hz	15.63	50.00
576p(625p)@50Hz	31.25	50.00
720p(750p)@60Hz	45.00	60.00
720p(750p)@50Hz	37.50	50.00
1080i(1125i)@60Hz	33.75	60.00
1080i(1125i)@50Hz	28.13	50.00

\* DVI digital input is not supported.

### List of supported signals (Video, S-Video signals)

Video mode	fh(kHz)	fv(Hz)	fsc(MHz)
NTSC	15.73	60	3.58
PAL	15.63	50	4.43
SECAM	15.63	50	4.25 or 4.41
PAL-M	15.73	60	3.58
PAL-N	15.63	50	3.58
PAL-60	15.73	60	4.43
NTSC4.43	15.73	60	4.43

### Pin assignment of COMPUTER-2 & MONITOR terminals

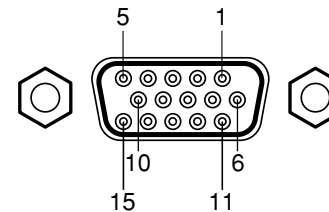

Mini D sub 15 Pin connector

#### Input Signal

- RGB input
  - RGB signals: 0.7V (p-p) 75 Ω
  - Horizontal sync signal: TTL level (Pos/neg polarity)
  - Vertical sync signal: TTL level (Pos/neg polarity)
- Y/P<sub>B</sub>/P<sub>R</sub> input
  - Y signal: 1.0V (p-p) 75 Ω
  - P<sub>B</sub>/P<sub>R</sub> signals: 0.7V (p-p) 75 Ω

Pin No.	Pin description	
	During RGB input	During Y/P <sub>B</sub> /P <sub>R</sub> input
1	Video signal (R)	Color difference signal (P <sub>R</sub> )
2	Video signal (G)	Luminance signal (Y)
3	Video signal (B)	Color difference signal (P <sub>B</sub> )
4	GND	*
5	GND	*
6	GND (R)	GND (P <sub>R</sub> )
7	GND (G)	GND (Y)
8	GND (B)	GND (P <sub>B</sub> )
9	N.C	*
10	GND	*
11	GND	*
12	N.C	*
13	Horizontal sync signal	*
14	Vertical sync signal	*
15	N.C	*

\* Do not connect anything.

## Specifications (Continued)

### Pin assignment of DVI-I terminal

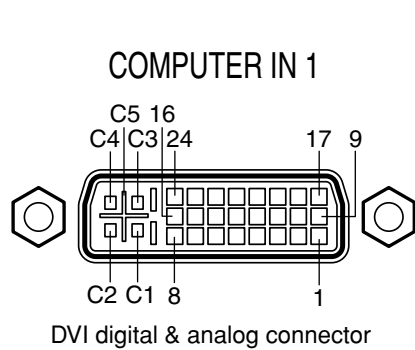

- Analog input signal
- Analog RGB input  
RGB signals: 0.7V (p-p) 75 Ω
  - Horizontal sync signal: TTL level (Pos/neg polarity)
  - Vertical sync signal: TTL level (Pos/neg polarity)
  - Y/P<sub>B</sub>/P<sub>R</sub> input  
Y signal: 1.0V (p-p) 75 Ω
  - P<sub>B</sub>/P<sub>R</sub> signals: 0.7V (p-p) 75 Ω

Pin No.	Pin description
1	T.M.D.S. data 2 -
2	T.M.D.S. data 2 +
3	T.M.D.S. data 2/4 shielded
4	T.M.D.S. data 4 - (N.C)
5	T.M.D.S. data 4 + (N.C)
6	DDC clock
7	DDC data
8	Analog vertical sync signal
9	T.M.D.S. data 1 -
10	T.M.D.S. data 1 +
11	T.M.D.S. data 1/3 shielded
12	T.M.D.S. data 3 - (N.C)
13	T.M.D.S. data 3 + (N.C)
14	+5V power source
15	GND(+5V, H Sync & V Sync)

Pin No.	Pin description
16	Hot plug detection
17	T.M.D.S. data 0 -
18	T.M.D.S. data 0 +
19	T.M.D.S. data 0/5 shielded
20	T.M.D.S. data 5 - (N.C)
21	T.M.D.S. data 5 + (N.C)
22	T.M.D.S. clock shielded
23	T.M.D.S. clock +
24	T.M.D.S. clock -
C1	Analog video signal (R / P <sub>R</sub> )
C2	Analog video signal (G / Y)
C3	Analog video signal (B / P <sub>B</sub> )
C4	Analog horizontal sync signal
C5	Analog GND(R/P <sub>R</sub> ,G/Y,B/P <sub>B</sub> )

### CONTROL terminal

#### Pin assignment

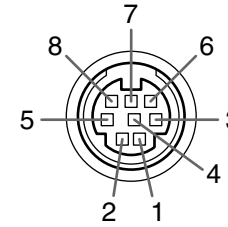

Mini DIN 8 pin connector

Pin No.	Signal Name	Description
1	RXD	Receiving data
2	CTS	Consent to send
3	DSR	Data set ready
4	GND	Signal ground
5	RTS	Request to send
6	N.C	No connection
7	TXD	Sending data
8	GND	Signal ground

#### Interface format

- Communication method: RS-232C, 9600bps, No Parity, Data Length: 8 bits; Stop Bit Length: 1 bit
- Communication format: STX (02h) | Command (3Byte) | ETX (03h)  
Only 1 command valid per communication.
- Data format: For input commands, only ASCII-compliant all-uppercase alphanumeric characters supported.
- Replies:
 

Acknowledge	ACK (06h)   CR (0Dh)   Data	... Normally ended
	ACK (06h)   ESC (1Bh)	... Aborted
No acknowledge	NAK (15h)	

If commands are to be sent consecutively, wait for the response from the projector before sending the next command.

#### Main Commands

Item	Command
Power on	PON
Power off	POF
Icon display on	MO0
Icon display off	MO1
Auto setting (RGB input)	PAT
Status display on	DON
Status display off	DOF

#### Note

- Contact your dealer for control cable and other commands.

**TOSHIBA CORPORATION**