

TOSHIBA

OWNER'S MANUAL

DATA PROJECTOR

TDP-TW90

(XGA / With PC Card Slot)

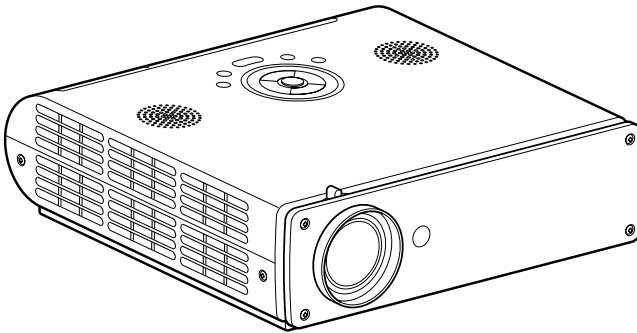

Before Using

Preparations

Operations

Maintenance

Others

SAFETY PRECAUTIONS



The lightning flash with arrowhead symbol, within an equilateral triangle, is intended to alert the user to the presence of uninsulated "dangerous voltage" within the product's enclosure that may be of sufficient magnitude to constitute a risk of electric shock to persons.



The exclamation point within an equilateral triangle is intended to alert the user to the presence of important operating and maintenance (servicing) instructions in the literature accompanying the appliance.

WARNING: TO REDUCE THE RISK OF FIRE OR ELECTRIC SHOCK, DO NOT EXPOSE THIS APPLIANCE TO RAIN OR MOISTURE. DANGEROUS HIGH VOLTAGES ARE PRESENT INSIDE THE ENCLOSURE. DO NOT OPEN THE CABINET. REFER SERVICING TO QUALIFIED PERSONNEL ONLY.

WARNING: Handling the cord on this product or cords associated with accessories sold with this product, will expose you to lead, a chemical known to the State of California to cause birth defects or other reproductive harm. **Wash hands after handling.**

WARNING: This [product] contains mercury. Disposal of mercury may be regulated due to environmental considerations. For disposal or recycling information, please contact your local authorities or the Electronic Industries Alliance: www.eiae.org.

FCC Radio Frequency Interference Statement

Note: This equipment has been tested and found to comply with the limits for a Class A digital device, pursuant to part 15 of the FCC Rules. These limits are designed to provide reasonable protection against harmful interference when the equipment is operated in a commercial environment. This equipment generates, uses, and can radiates radio frequency energy and, if not installed and used in accordance with the instruction manual, may cause harmful interference to radio communications. Operation of this equipment in a residential area is likely to cause harmful interference in which case the user will be required to correct the interference at his own expense.

WARNING: Changes or modifications made to this equipment, not expressly approved by Toshiba, or parties authorized by Toshiba, could void the user's authority to operate the equipment.

Notice: This Class A digital apparatus complies with Canadian ICES-003. Cet appareil numérique de la classe A est conforme à la norme NMB-003 du Canada.

WARNING: This is a Class A product. In a domestic environment this product may cause radio interference in which case the user may be required to take adequate measures.

IMPORTANT SAFETY INSTRUCTIONS

CAUTION: PLEASE READ AND OBSERVE ALL WARNINGS AND INSTRUCTIONS GIVEN IN THIS OWNER'S MANUAL AND THOSE MARKED ON THE UNIT. RETAIN THIS BOOKLET FOR FUTURE REFERENCE.

This set has been designed and manufactured to assure personal safety. Improper use can result in electric shock or fire hazard. The safeguards incorporated in this unit will protect you if you observe the following procedures for installation, use and servicing. This unit is fully transistorized and does not contain any parts that can be repaired by the user.

DO NOT REMOVE THE CABINET COVER, OR YOU MAY BE EXPOSED TO DANGEROUS VOLTAGE. REFER SERVICING TO QUALIFIED SERVICE PERSONNEL ONLY.

1. Read Owner's Manual

After unpacking this product, read the owner's manual carefully, and follow all the operating and other instructions.



2. Power Sources

This product should be operated only from the type of power source indicated on the marking label. If you are not sure of the type of power supply to your home, consult your product dealer or local power company. For products intended to operate from battery power, or other sources, refer to the operating instructions.



3. Source of Light

Do not look into the lens while the lamp is on. The strong light from the lamp may cause damage to your eyes or sight.



4. Ventilation

Openings in the cabinet are provided for ventilation and to ensure reliable operation of the product and to protect it from overheating, and these openings must not be blocked or covered. The openings should never be blocked by placing the product on a bed, sofa, rug or other similar surface. This product should not be placed in a built-in installation such as a bookcase or rack unless proper ventilation is provided or the manufacturer's instructions have been adhered to.



IMPORTANT SAFETY INSTRUCTIONS (Continued)

5. Heat

The product should be situated away from heat sources such as radiators, heat registers, stoves, or other products (including amplifiers) that produce heat.

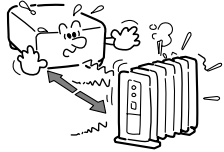

6. Water and Moisture

Do not use this product near water. - for example, near a bath tub, wash bowl, kitchen sink, or laundry tub; in a wet basement; or near a swimming pool and the like.

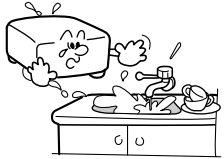

7. Cleaning

Unplug this product from the wall outlet before cleaning. Do not use liquid cleaners or aerosol cleaners. Use a soft cloth for cleaning.

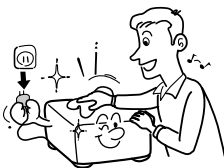

8. Power-Cord Protection

Power-supply cords should be routed so that they are not likely to be walked on or pinched by items placed upon or against them, paying particular attention to cords at plugs, convenience receptacles, and the point where they exit from the product.



9. Overloading

Do not overload wall outlets; extension cords, or integral convenience receptacles as this can result in a risk of fire or electric shock.



10. Lightning storms

For added protection for this product during storm, or when it is left unattended and unused for long periods of time, unplug it from the wall outlet. This will prevent damage to the product due to lightning and power-line surges. However, while it is thundering or lightning, do not touch the apparatus and any connected cable and/or equipment. This will prevent you from receiving the electric shock by an electric surge.



11. Object and Liquid Entry

Never push objects of any kind into this product through openings as they may touch dangerous voltage points or short-out parts that could result in a fire or electric shock. Never spill liquid of any kind on the product.



12. Do not place the product vertically

Do not use the product in the upright position to project the pictures at the ceiling, or any other vertical positions. It may fall down and dangerous.

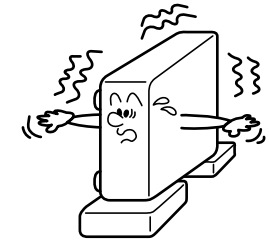

13. Stack Inhibited

Do not stack other equipment on this product or do not place this product on the other equipment. Top and bottom plates of this product develops heat and may give some undesirable damage to other unit.

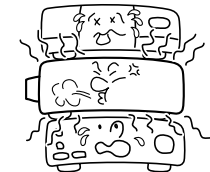

14. Attachments

Do not use attachments not recommended by the product manufacturer as they may cause hazards.

IMPORTANT SAFETY INSTRUCTIONS (Continued)

15. Accessories

Do not place this product on an unstable cart, stand, tripod, bracket, or table. The product may fall, causing serious injury to a child or adult, and serious damage to the product. A product and cart combination should be moved with care. Quick stops, excessive force, and uneven surfaces may cause the product and cart combination to overturn.



16. Damage Requiring Service

Unplug this product from the wall outlet and refer servicing to qualified service personnel under the following conditions:

- When the power-supply cord or plug is damaged.
- If liquid has been spilled, or objects have fallen into the product.
- If the product has been exposed to rain or water.
- If the product does not operate normally by following the operating instructions. Adjust only those controls that are covered by the operating instructions as an improper adjustment of other controls may result in damage and will often require extensive work by a qualified technician to restore the product to its normal operation.

- If the product has been dropped or damaged in any way.
- When the product exhibits a distinct change in performance - this indicates a need for service.

17. If glass components, including lens and lamp, should break, contact your dealer for repair service.

This product incorporates glass components, including a lens and a lamp. If such parts should break, please handle with care to avoid injury and contact your dealer for repair service. The broken pieces of glass may cause injury. In the unlikely event of the lamp rupturing, thoroughly clean the area around the projector and discard any edible items placed in that area.

18. Servicing

Do not attempt to service this product yourself as opening or removing covers may expose you to dangerous voltage or other hazards. Refer all servicing to qualified service personnel.



19. Replacement Parts

When replacement parts are required, be sure the service technician has used replacement parts specified by the manufacturer or have the same characteristics as the original part. Unauthorized substitutions may result in fire, electric shock, or other hazards. (Replacement of the lamp only should be made by users.)

20. Safety Check

Upon completion of any service or repairs to this product, ask the service technician to perform safety checks to determine that the product is in proper operating condition.

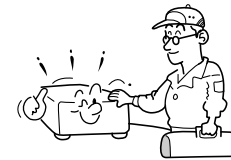

21. Do not leave thermal-paper documents or easily deformed items on top of the unit or near the air exhaust for long periods of time.

The heat from the unit could erase the information on the thermal paper, or cause deformation or warping.

22. Do not use the product in a closed installation state.

Do not place the product in a box or in any other closed installation state. Otherwise it may overheat. This could result in a risk of fire.

23. When using a wireless LAN PC card:

- Do not use near people with heart pacemakers
- Do not use near electronic medical equipment, or in hospitals or other medical institutions
- Do not use inside aircraft or in places where the wireless LAN card could interfere with electromagnetic signals.

The electromagnetic interference could cause a malfunction, resulting in an accident.

24. If the use of a wireless LAN PC card interferes with another device's electromagnetic signals, cease use immediately.

The electromagnetic interference could cause a malfunction, resulting in an accident.

IMPORTANT SAFETY INSTRUCTIONS (Continued)

25. Do not carry the projector by having the terminal cover parts or the PC card cover part

Doing so, the projector may fall if that cover comes off, and injury or damage may result.

POWER SUPPLY CORD SELECTION

If your line voltage is 220 to 240V, use one of the following types of cable.

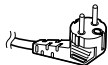
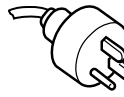
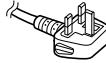
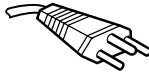
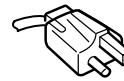
Plug configuration	Plug type	Line voltage	Plug configuration	Plug type	Line voltage
	EURO	220 – 240V		Australian 240V 10A	200 – 240V
	UK	220 – 240V		Switzerland 240V 6A	200 – 240V
Use a 5A fuse which is approved by ASTA or BSI to BSI362. Always replace the fuse cover after changing the fuse.				North American 240V 15A	200 – 240V

IMPORTANT PRECAUTIONS

Save Original Packing Materials

The original shipping carton and packing materials will come in handy if you ever have to ship your projector. For maximum protection, repack the set as it was originally packed at the factory.

Moisture Condensation

Never operate this unit immediately after moving it from a cold location to a warm location. When the unit is exposed to such a change in temperature, moisture may condense on the crucial internal parts. To prevent the unit from possible damage, do not use the unit for at least 2 hours when there is an extreme or sudden change in temperature.

Place and Manner of Installation

- Do not place in hot locations, such as near heating equipment. Doing so could cause malfunction, and shorten the life of the projector.
- Avoid locations with oil or cigarette smoke. Doing so will dirty the optical parts, shortening their lives, and darkening the screen.
- Do not use the product vertically in any upright position or slantwise in an angle of 20 degrees or more.
- Using this instrument near a TV or radio may cause interference to the images or audio sound. If this happens, move it away from the TV or radio.
- Moving the projector from a low-temperature room to a high-temperature room may cause condensation on the lens or internal parts in the instrument. If you continue to use it in that situation, the malfunction may result. Ensure to wait until the condensation naturally disappears.
- In a high altitude location where air is thin, cooling efficiency is reduced so use it with the ambient temperature being lowered.

IMPORTANT PRECAUTIONS (Continued)

Avoid Volatile Liquid

Do not use volatile liquids, such as an insect spray, near the unit. Do not leave rubber or plastic products touching the unit for a long time. They will leave marks on the finish. If cleaning with a chemically saturated cloth, be sure to follow the product's precautions.

Wireless LAN PC Card

- Do not connect the supplied wireless LAN PC card to devices other than this unit. Doing so could cause malfunction.
- To protect the PC card from static electricity, touch some nearby metal, such as a doorknob or aluminum window frame, before touching the PC card, to rid your body of static electricity.
- This PC card is a radio product. Concerning the regulations applied in each country/area, please refer to "Information to the user" supplied.

In the spaces provided below, record the Model and Serial No. located at the bottom of your projector.

Model No. _____ Serial No. _____

Retain this information for future reference.

EXEMPTION CLAUSES

- Toshiba Corporation bears no responsibility in the case of damages arising from natural disaster such as earthquakes, lightning, etc., fire not liable to Toshiba Corporation, operation, theft or mischief by third parties, other accidents, or use under abnormal conditions including erroneous or improper operation and other problems.
- Toshiba Corporation bears no responsibility for incidental damages (lost profit, work interruption, corruption or loss of the memory contents, etc.) arising from the use of or the inability to use this unit.
- Toshiba Corporation accepts no liability whatsoever for any damages arising from not having followed the descriptions in this Instruction Manual.
- Toshiba Corporation accepts no liability whatsoever for any damages arising from malfunctions arising from combination with equipment or software that is not related to Toshiba Corporation.
- Toshiba bears no responsibility for information being intercepted or leaked due to the use of a wireless LAN, or any damages therefor.

OTHER CAUTIONS AND INFORMATIONS

Copyrights

Showing or transmitting commercial imaging software or broadcast or cable-broad casting programs with the purpose of other than the personal and private viewing, including modifying images using the freeze or resize functions, or displaying with the varying aspect ratio of the images, could violate the direct or indirect copyrights of the imaging software or broadcast program, etc., if done without first consulting with the copyright holder. For this reason, please take appropriate measures before performing one of the actions listed above, including obtaining a license from the copyright holder.

Disposal

This product contains substances which are harmful to humans and the environment.

- Solder used in the internal parts contains the lead.
- The lamp contains inorganic mercury.

Please dispose of this product or used lamps in accordance with local regulations.

Trademarks

- VGA, SVGA, XGA, SXGA, UXGA are trademarks or registered trademarks of International Business Machines Corporation.
- Digital Light Processing, Digital Micromirror Device and DMD are trademarks of Texas Instruments.
- Macintosh is a registered trademark of Apple Computer, Inc.
- Windows is a registered trademark of Microsoft Corporation in the U.S. and other countries.
- Adobe is a registered trademark and Acrobat Reader is a trademark of Adobe Systems Incorporated.

Notational Conventions Used in This Manual

- References to pages with related information are annotated as follows. For example, if making a reference to page 36: [p.36](#)
- The illustrations in this document are for reference purposes only and may not reflect your package exactly.

REMOTE CONTROL BATTERIES

- Be sure to use AA size batteries.
- Do not reverse the polarity when inserting the battery.
- Do not recharge, heat, disassemble, short-circuit, or burn the battery.
- Do not use the battery beyond the expiration date indicated on the battery or leave a dead battery in the remote control.
- Do not mix batteries of different types, such as alkaline and manganese. Do not mix new and used batteries.

Using the batteries improperly may cause them to explode or leak and lead to burn or injury. If battery-leaking fluid contacts skin, wash the fluid off immediately with clean water and consult a doctor. If the fluid is spilt on an instrument, avoid contact and wipe it off using tissue paper. (Dispose of the used tissue paper as flammable garbage after moistening with water.)

CONTENTS

Before Using

SAFETY PRECAUTIONS	2
IMPORTANT SAFETY INSTRUCTIONS	3
POWER SUPPLY CORD SELECTION	9
IMPORTANT PRECAUTIONS	9
EXEMPTION CLAUSES	10
OTHER CAUTIONS AND INFORMATIONS	11
REMOTE CONTROL BATTERIES	11
CONTENTS	12

Preparations

Checking the package contents	14
Names of each part on the main unit	15
Names of each part on the control panel and remote control	16
Parts on the rear panel	17
Preparing and using the remote control	18
Placement	19
Connection	20
How to use the PC card slot	21

Operations

Turning the power on and off	22
Basic operations	24
Using handy features	26
Using auto setting	26
Cutting off the picture and sound temporarily (Mute)	28
Freezing the image (Freeze)	28
Using the menus	29
How to use the menus	29
The image adjustment menu	30
The display setting menu	31
The default setting menu	32
Displaying Information (Status display)	33
Setting up the wireless LAN	34
Functions	34
Communication mode	34
Caution when using the wireless LAN functions	35
Setup using the Wireless/Card menu	36
How to enter characters	37
Setting up the network	38
Computer settings	41
Projecting images stored in a memory PC card	42
Memory PC cards	42
JPEG files	43
Setting slideshow options	43

Automatic demonstration	45
Playing a slide show from a thumbnail list	46
Checking the projector status	48
Status display	48
Installing the applications	49
Using the Wireless Utility	50
Displaying a computer's screen via the projector	50
Displaying a JPEG image saved on a computer via the projector	52
Operating the projector	53
Document camera function	54
How to use the JPEG Conversion Tool	55
Launching the JPEG Conversion Tool	55
Converting an image file	55
Converting files created with Microsoft® PowerPoint®	56
Making a presentation with converted JPEG files	57
Creating a screen capture and converting it into a JPEG file	57
Setting up the projector using a Web browser	58
How to use the "Projector Configuration Tool"	58

Maintenance

About lamp	62
Lamp replacement	62
Lens and main unit cleaning	64

Others

Trouble indications	65
Before calling service personnel	66
Specifications	68
List of general specifications	68
Separately sold product	68
List of supported signals (RGB signals)	69
List of supported signals (Y/Pb/Pr signals)	70
List of supported signals (Video, S-Video signals)	70
Pin assignment of COMPUTER-1/2 & MONITOR terminals	70
CONTROL terminal	71

Checking the package contents

Please make sure that the following items are included in the box, along with the main unit. If any item is missing, please contact the store immediately where you purchased the product.

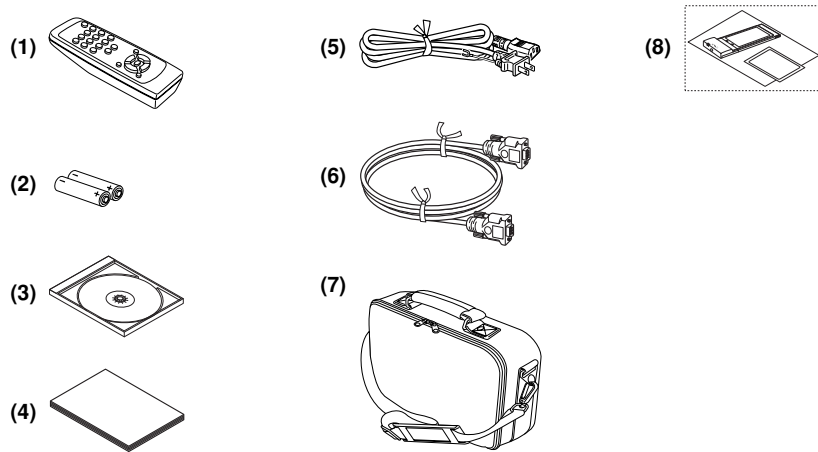

- (1) Remote control
- (2) R6 (SIZE AA) batteries for remote control (2)
- (3) CD-ROM
- (4) Owner's Manual
- (5) Power cord (See note)
- (6) RGB cable (3m)
- (7) Carrying bag
- (8) Wireless LAN PC card
 - "About the Wireless LAN PC Card"
 - Sticker

Note

The shape and number of supplied power cords vary depending on the product destination.

◆The Supplied CD-ROM

The supplied CD-ROM contains the owner's manual including information not available for its simplified hardcopy, Owner's Manual (Getting Started), Acrobat® Reader™ to view the manual, and application software [p.49](#) to use the functions of the wireless LAN/PC card.

■ Installing Acrobat® Reader™

Windows®: Run the CD-ROM, select the **Reader/English** folder, and run **ar500enu.exe**. Follow the on-screen instructions.

Macintosh: Run the CD-ROM, select the **Reader/English** folder, and run **Reader Installer**. Follow the on-screen instructions to install the software.

■ Viewing the manual

Run the CD-ROM and double-click on **Start.pdf**. Acrobat® Reader™ launches, and the menu screen of the Owner's manual appears. Click on your language. The Owner's Manual cover and list of bookmarks appear. Click on a bookmark title to view that section of the manual. Click on [p.](#) to view a reference page with related information. See the Help menu for more information about Acrobat® Reader™.

Names of each part on the main unit

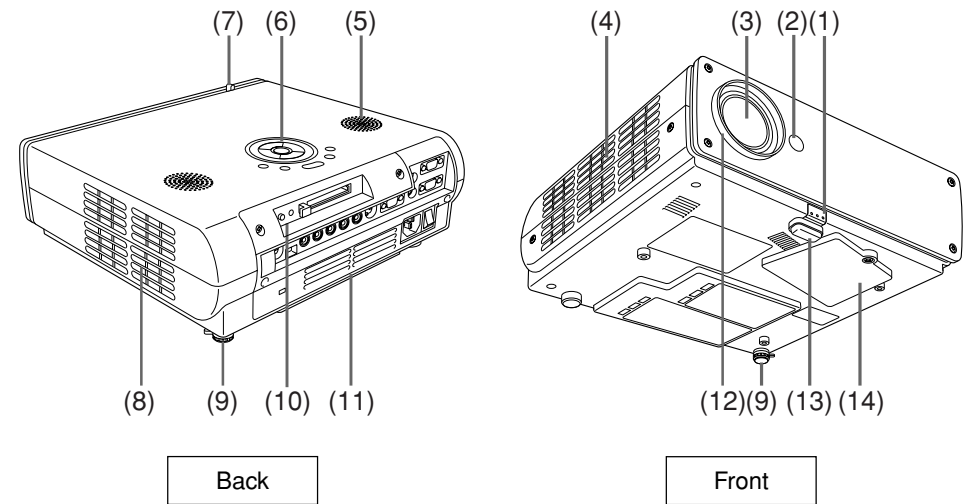

Name	Function
(1) Foot adjuster release button	: Press to stow the foot adjuster. p.25
(2) Infrared remote sensor	: Senses commands from the remote control. p.18
(3) Lens	: Projects expanded image.
(4) Air intake	: Draws in air from outside the projector.
(5) Speaker	: Outputs audio sound.
(6) Control panel	: Operates the projector. p.16
(7) Zooming lever	: Adjusts screen size. p.25
(8) Air exhaust	: Expels air that has grown hot inside the projector.
(9) Tilt adjuster	: Adjusts the projector's horizontal tilt. p.25
(10) PC card slot section	: Mounts/removes the PC card. p.21
(11) Rear panel	: Connects external devices. p.17
(12) Focusing ring	: Adjusts screen focus. p.25
(13) Foot adjuster	: Adjusts the vertical projection angle. p.25
(14) Lamp cover	: Remove to replace lamp. p.63

Names of each part on the control panel and remote control

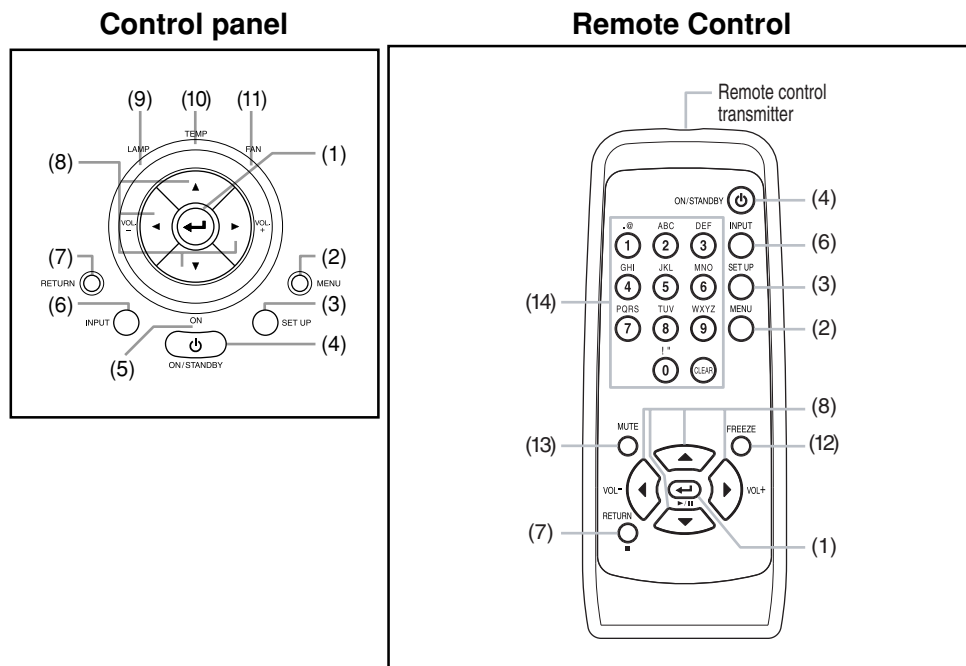

Name	Main Function
(1) ENTER button	: Accepts the selected mode.
(2) MENU button	: Displays menus. p.29
(3) SET UP button	: Sets up image and mode. p.26
(4) ON/STANDBY button	: Turns the power on/off (standby). p.22
(5) ON indicator	: Displays whether power is on or off. p.22
(6) INPUT button	: Selects input. p.24
(7) RETURN button	: Goes back one screen.
(8) Selection button	: Menu selections and adjustments, etc. p.30
(9) LAMP indicator	: Displays lamp mode. p.23
(10) TEMP indicator	: Lights when internal temperature too high. p.65
(11) FAN indicator	: Displays cooling fan mode. p.65
(12) FREEZE button	: Pauses image. p.28
(13) MUTE button	: Cuts off the picture and sound temporarily. p.28
(14) Numeric keypad	: Use to set up the wireless LAN. Numbers and characters can be entered. p.37

Note

- For the remainder of this manual, buttons are referred to as follows:
Selection buttons ⇒ ; ENTER button ⇒

Parts on the rear panel

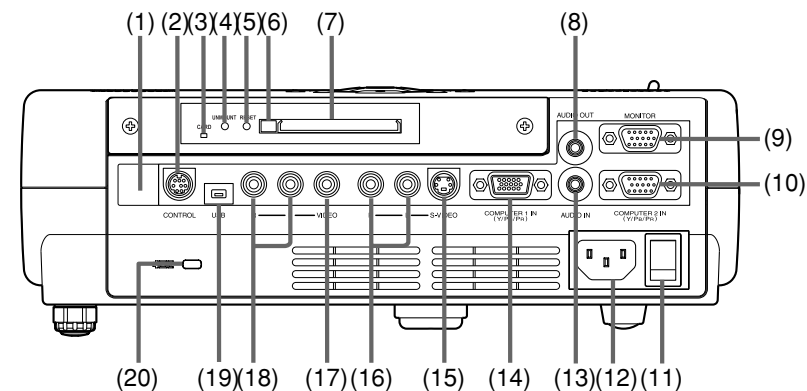

Name	Main Function
(1) Infrared remote sensor	: Senses commands from the remote control. p.18
(2) CONTROL terminal	: When operating the projector via a computer, connect this to the controlling computer's RS-232C port. p.71
(3) CARD indicator	: Displays PC card's status. p.21
(4) UNMOUNT button	: Press before removing PC card. p.21
(5) RESET switch (inside depression)	: Press if CARD indicator turns red. p.21
(6) Eject button	: Press to remove PC card. p.21
(7) PC card slot	: Insert PC cards here. p.21
(8) AUDIO OUT terminal	: Outputs audio signals.
(9) MONITOR terminal	: Connect to a computer display, etc.
(10) COMPUTER 2 terminal	: Input RGB signal from a computer or other source, or a component video signal (Y/Pb/Pr) from video equipment.
(11) Main power switch	: AC power line ON (standby)/OFF.
(12) AC IN socket	: Connect the supplied power cord here.
(13) AUDIO IN terminal	: Input audio signals from a computer or video equipment with a component video signal output terminal.
(14) COMPUTER 1 terminal	: Input RGB signal from a computer or other source, or a component video signal (Y/Pb/Pr) from video equipment.
(15) S-VIDEO terminal	: Input S video signals from video equipment.
(16) AUDIO (L/R) terminal	: Input audio signals from video equipment.
(17) VIDEO terminal	: Input video signals from video equipment.
(18) AUDIO (L/R) terminal	: Input audio signals from video equipment.
(19) USB terminal	: Provided for servicing purposes only. Do not use for any connection.
(20) Antitheft lock hole	: Attach a safety cable or any other antitheft device.

Note

- Although this owner's manual abbreviates component video signals as Y/Pb/Pr, the product also supports signals from video equipment marked "Y/Cb/Cr."

Preparing and using the remote control

■ Loading dry-cell batteries into the remote control

- 1 Remove the battery cover.

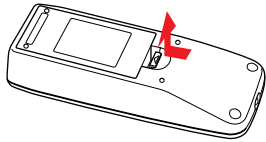

- 2 Insert the dry-cell batteries.

Be sure to align the plus and minus ends of the batteries properly.

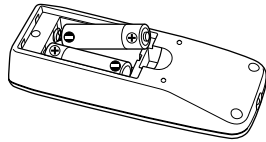

Two batteries (R6, SIZE AA) are used.

- 3 Replace the battery cover.

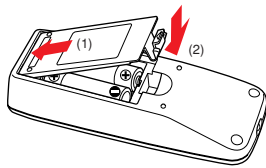

■ Dry-cell batteries

- Before using the batteries, be sure to observe the Safety Precautions described in previous pages.
- Remove batteries from remote control when not using for extended periods.
- If the remote control stops working, or if its range decreases, replace all the batteries with new ones.

■ The remote control

- The remote control may fail to operate if the infrared remote sensor is exposed to bright sunlight or fluorescent lighting.
- Do not drop or bang.
- Do not leave in hot or humid locations.
- Do not get wet or place on top of wet objects.
- Do not take apart.
- In rare cases, ambient conditions could impede the operation of the remote control. If this happens, point the remote control at the main unit again, and repeat the operation.

■ Operating the remote control

Point the remote control toward the projector's infrared remote sensor, and press a button on the remote control.

- Operating the projector from the front

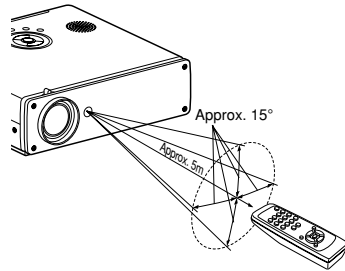

- Operating the projector from the rear

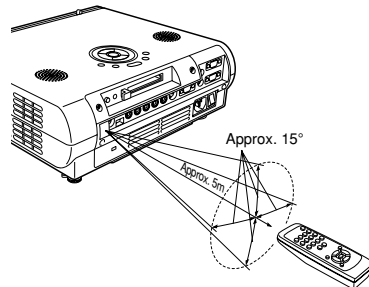

Placement

Placement Styles

As shown in the figures below, this device can be placed in 4 different styles. The factory setting is "floor-mounted front projection." Set the **Projection mode** in the default setting menu [p.32](#), in accordance with your needs.

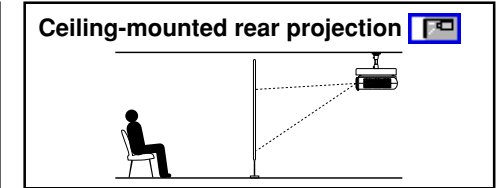
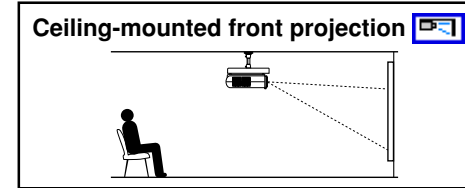
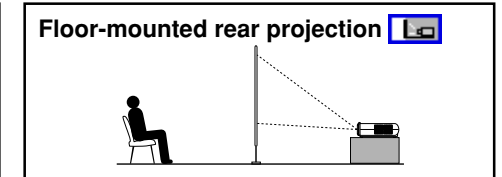
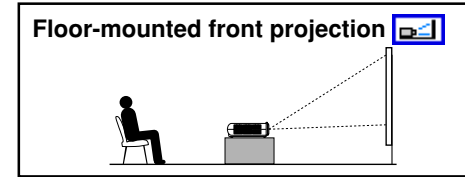

⚠ WARNING

- Always obey the instructions listed in IMPORTANT SAFETY INSTRUCTIONS when placing the unit. Attempting to clean/replace the lamp at a high site by yourself may cause you to drop down, thus resulting in injury.
- If you wish to mount the projector on the ceiling, be sure to ask your dealer to do so. Mounting the projector on a ceiling requires special ceiling brackets (sold separately) and specialized knowledge. Improper mounting could cause the projector to fall, resulting in an accident.
- If the projector is ceiling-mounted, install the breaker for turning off the power in case of anomaly. Let everyone involved with the use of the projector know that fact.

Projection Distance and Size

Use the figures, tables, and formulas below to determine the projection size and projection distance. (Projection sizes are approximate values for full-size picture with no keystone adjustment.)

Screen **As seen from above**

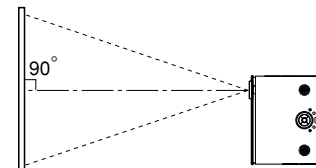

As seen from the side

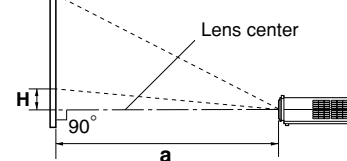

$$a \text{ (min length)} = \text{projection size (inches)} \times 0.04064$$

$$a \text{ (max length)} = \text{projection size (inches)} \times 0.04878$$

projection size (inches)	projection distance a (m)		height (H) (cm)
	min length (zooming max)	max length (zooming min)	
24.6	—	1.20	5.6
40	1.62	1.95	9.1
60	2.44	2.93	13.8
80	3.25	3.90	18.3
100	4.00	4.88	22.9
150	6.10	7.30	34.3
200	8.10	9.76	45.7
246	10.00	—	56.2

a is the distance (m) between the lens and the screen, and corresponds to a range of 1.20 m to 10.00 m. **H** is the height from the image bottom to the center of the lens.

Connection

Before connection

- Read the owner's manual of the device you are connecting to the projector.
- Some types of computer cannot be used or connected to this projector. Check for an RGB output terminal, supported signal [p.69](#), etc.
- Turn off the power of both devices before connecting.
- The figure below is a sample connection. This does not mean that all of these devices can or must be connected simultaneously. (Dotted lines mean items can be exchanged.)

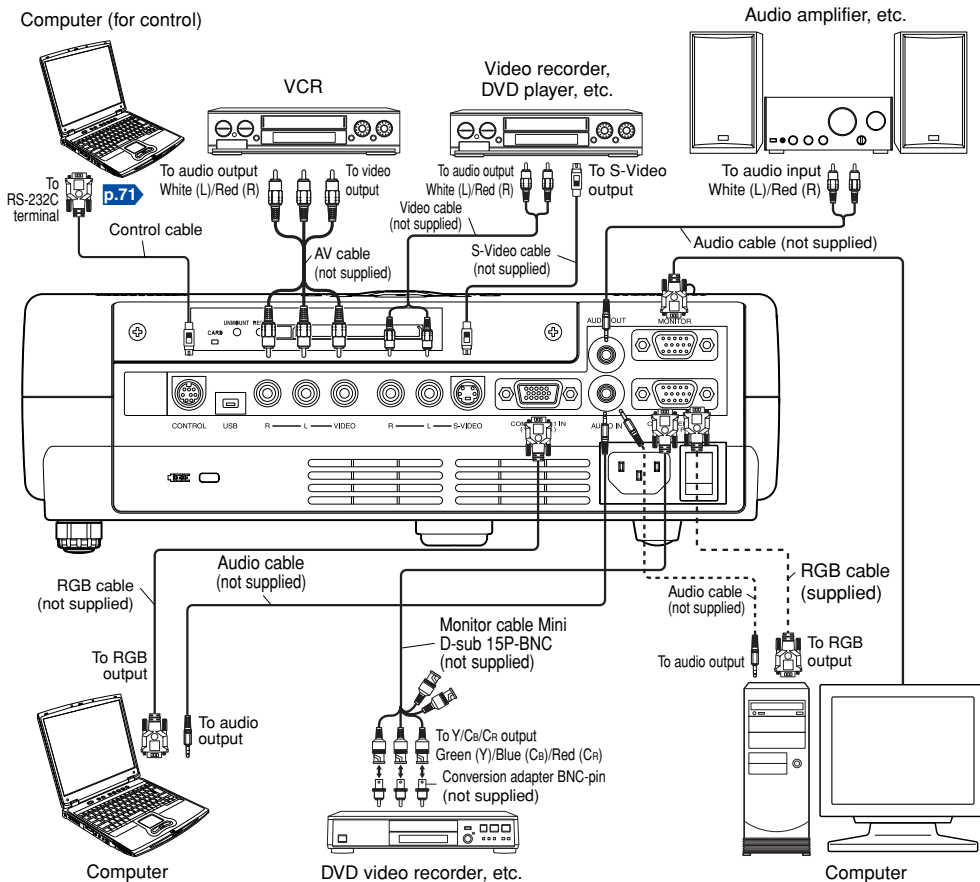

Notes

- COMPUTER terminals 1 and 2 function identically.
- The AUDIO IN terminal doubles for devices connected to COMPUTER terminals 1 and 2.

How to use the PC card slot

The wireless LAN PC card enables you to connect the projector wirelessly with a personal computer that supports IEEE802.11b based wireless LAN. [p.34](#) (Please note that communication between all the computers based on IEEE802.11b and this projector is not guaranteed.) You can also use a commercially available memory card to project JPEG image files using this projector. [p.42](#) Please follow the steps below when removing or mounting a PC card.

Mounting a PC card

- 1 **Insert the PC card.**
After making sure of the card orientation, press it in firmly until it stops.

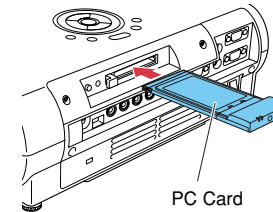

When the PC card is detected correctly, the CARD indicator comes on in green.

Removing a PC card

- 1 **Look at CARD indicator.**
If it is off, proceed to step ④.
- 2 **Press the UNMOUNT button.**
Begins processing for PC card removal.
- 3 **Wait until CARD indicator goes out.**
Never remove the PC card while lit. Doing so could damage the PC card or corrupt your data.
- 4 **Press the Eject button.**

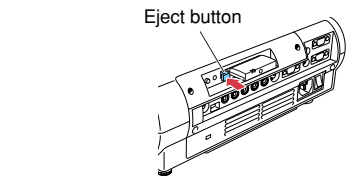
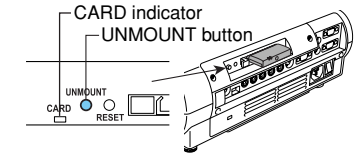

The Eject button is a bit stiff, so press firmly while supporting the projector. Be careful to avoid injury when doing so.

If CARD indicator turns red

Press the RESET switch with a thin pin or similar implement (it is at the bottom of a recess).

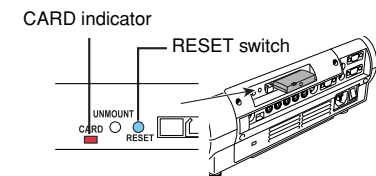

Turning the power on and off

■ Connecting the power cord

- 1 Insert the power cord connector into the AC IN socket of the projector.
- 2 Insert the power cord plug into a wall or other power outlet.

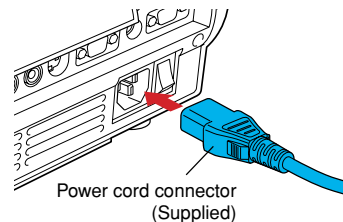

■ Removing the lens cover

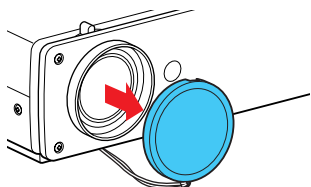

Be sure to remove the lens cover when the power is turned on. If it is left on, it could become deformed due to heat.

■ Turning the power on

- 1 Turn on the main power switch.

The ON indicator will change to orange, indicating standby mode.

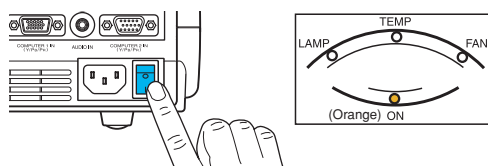

- 2 Press the ON/STANDBY button.

The power turns on, and the following 3 green indicators light: ON, LAMP, and FAN. After a moment, the start-up screen appears.

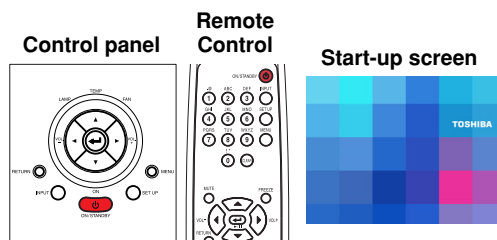

⚠ CAUTION

- Do not look into the lens while the lamp is on. The strong light from the lamp may cause damage to your eyes or sight.
- Do not block the air intake or exhaust. Doing so could cause a fire due to internal overheating.
- Do not place your hands, face, or other objects near the air exhaust. Doing so could cause burns, deform/break the object.

■ Notes

- The start-up screen will disappear after a moment. You can dismiss the start-up screen before this by performing any operation. You can also configure the start-up screen not to appear via the **Display setting menu** [p.31](#).
- The first time you use the projector after purchase, after the start-up screen disappears, the Language menu is displayed [p.24](#).

■ Turning the power off

- 1 Press the ON/STANDBY button.

A message appears on the screen, confirming that you wish to shut off the power. This message will disappear after a moment. (This operation is no longer valid after the message disappears.)

- 2 Press the ON/STANDBY button again.

The screen turns off, but the internal cooling fan continues to operate for a short while. Then, the projector goes into standby mode.

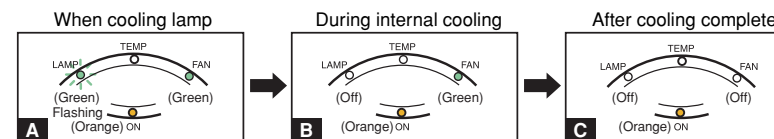

- A During cooling, the LAMP indicator flashes. In this state, the power cannot be turned back on.
- B After the LAMP indicator goes off, the cooling fan continues to operate for a short while, in order to expel excess internal heat. If you are in a hurry, there is no problem with unplugging the power cord or turning off the main power switch in this state.
- C In standby mode

■ Note

- The projector consumes about 18W of power in standby. We recommend that you unplug the power cord or turn off the main power switch if you will not be using the projector for an extended period.

■ PRECAUTION

- If the power cord is unplugged before cooling is complete, give the lamp time (about 5 minutes) to cool before plugging it back in. If the lamp overheats, it may fail to light, and its lifetime will be shortened.

Basic operations

1 Turn on the power.

Turn on the power by following the instructions in “Turning the power on” p.22.

2 Select the language and the lamp power (When using the first time).

When the projector is used for the first time after purchase, menu for language and lamp power selection and configuration is displayed in English. (If the screen is out of focus, adjust it according to the step 6.)

1 Use the ▲ or ▼ button to select the desired language and press the ⏺ button.

Message for setup confirmation is displayed in a selected language.

Then, the menu for lamp power selection and configuration is displayed. It is automatically set as Standard. To change the setting, follow the step 2.

2 Using the ▲ or ▼ button, select Low, Standard or High for the lamp power (menu item) and press the ⏺ button.

The lamp power, if selected, will be toggled without pressing the ⏺ button. The display automatically disappears in a few seconds.

English	English
Français	French
Deutsch	German
Italiano	Italian
Español	Spanish
Português	Portuguese
Русский	Russian
Svenska	Swedish
Türkçe	Turkish
日本語	Japanese
中文(简体字)	Chinese (simplified)
中文(繁體字)	Chinese (traditional)
한국어	Korean

Notes

- When the projector is turned on the next time, the Language and Lamp power menus do not appear upon startup. However, if “Reset all” is executed from the **Default setting** menu p.32, the Language and Lamp power menus will be displayed the next time when the power is turned on.
- The language can also be set via the Display setting menu p.31 and Lamp power via the Default setting menu p.32.
- This owner’s manual assumes that English has been selected.

3 Activate the connected device.

Turn on and start the connected device such as a computer.

4 Press the INPUT button.

An image of the connected equipment is projected.

Each time you press the INPUT button, it switches to the input of the connected equipment.

Notes

- When [Auto input search] is set to [On] in the **default setting menu** p.32, the image of the equipment which is connected and turned on is projected.
- Moving pictures generated with the DVD software for computers may appear unnatural if it is projected with this projector, but it is not a malfunction.

5 Projector placement angle adjustments

The placement angle and the height of the projected image can be adjusted by the foot adjuster.

1 Lift up the front of the projector to the desired angle, then press the foot adjuster release button.

The foot adjuster extends. Release the button to lock the position.

2 To adjust the horizontal angle, use the tilt adjuster.

To stow the foot adjuster, hold up the projector while pressing the foot adjuster release button, then slowly lower the projector.

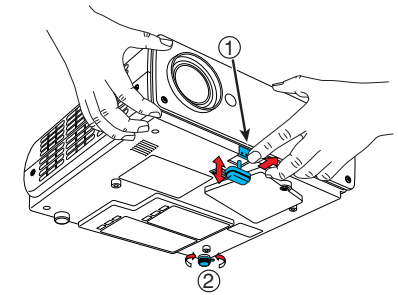

6 Adjusting the screen size and focus

1 Use the zooming lever to adjust the screen size.

2 Use the focusing ring to adjust the focus.

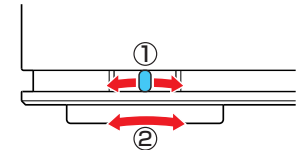

7 Adjusting the volume with the ◀ ▶ buttons

The speaker volume can be adjusted when an audio signal is being input.

Notes

- Note that a lamp characteristics may rarely cause the brightness to fluctuate slightly.
- A lamp is consumable item. If used for extended periods, images will appear dark, and the lamp could burn out. This is characteristic of a lamp, and is not malfunction. (The lifetime of the lamp depends on conditions of use.)
- The DMD™ is made using extremely advanced technology, but there may be black spots (pixels that do not light) or bright spots (pixels that are constantly lit) on the panel. Please note that these are not malfunctions.
- Although this projector supports a wide range of RGB signals p.69, any resolutions not supported by this projector (XGA) will be expanded or shrunk, which will affect image quality slightly. To view high-quality images, it is recommended that the computer’s external output should be set to XGA resolution.
- With some models of computer having LCD displays or the like, displaying images simultaneously on the projector and the monitor’s display may prevent the images from displaying properly. If this happens, turn off the computer’s LCD display. For information on how to turn off the LCD display, see the owner’s manual of your computer.
- If a signal not supported by the projector is input, the “Unsupported signal” will appear.
- If no signal is being input from the connected device, the “No signal” will appear.
- If an unavailable operation button is pressed, the ❌ icon will appear.

Using handy features

■ Using auto setting

This function sets up the projector to the optimum state for each type of the input signal by using simple operations.

1 Press the SET UP button.

The Set up menu appears.

2 Press the SET UP button again.

The menu item is automatically adjusted/set.

For computer input, the  icon will appear during processing.

For manual adjustment and setting, see the following table [p.27](#).

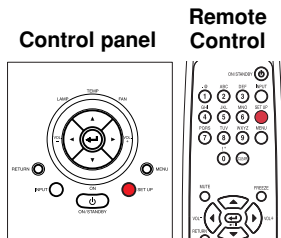

■ Note

- The image may not be projected or auto adjustment/setting may not be performed correctly for input signals other than those supported by the projector [p.69](#), [p.70](#).

● Correcting the keystone distortion

When the foot adjuster [p.25](#) is used to change the projector placement angle while projecting the image, the picture will undergo keystone (trapezoidal) distortion. This projector is capable of correcting this keystone distortion.

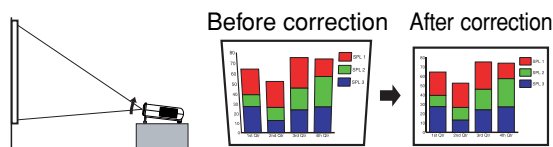



1 Press the SET UP button.

2 Press the button.

The keystone distortion is automatically corrected. The  icon appears during this correction.

● Manual adjustment





Press the SET UP button to display the Set up menu and select [Keystone]. Use the   buttons for keystone adjustment. When the adjustment is finished, press the RETURN button. The menu disappears.



























■ Notes

- Depending on the amount of keystone adjustment and the content of images, some information may be lost, or the picture quality may suffer.
- Keystone adjustment is available for the keystone distortion in a slant angle of ± 15 degrees.

● Manual adjustments and settings

The menu items of the Set up menu vary depending on the input type, as shown in the table below.

Use the      buttons to adjust the items in the table below, then press the RETURN button when you are finished.

Select Item  	Description	Computer	Y/Pb/Pb	Video S-video	PC card
 Auto. Keystone	Automatically corrects the keystone distortion. Press  .	Yes	Yes	Yes	Yes
 Keystone	Correct the keystone (trapezoid) distortion of the screen. Screen shrinking   Screen shrinking downward upward	Yes	Yes	Yes	Yes
 Auto setting	Automatically adjusts items such as the sampling phase depending on the type of input signal. Press the SET UP button.	Yes	No	No	No
 Phase	Adjust with   to eliminate flicker.	Yes	No	No	No
 Frequency	Adjust with   to eliminate periodic patterns and flickering when many vertical lines appear on the screen.	Yes	No	No	No
 H-position	Adjust the horizontal position of the image. Move left   Move right	Yes	No	No	No
 V-position	Adjust the vertical position of the image. Move down   Move up	Yes	No	No	No
 Clamp 1	Adjusts the clamp pulse position. Lower   Higher	Yes	No	No	No
 Clamp 2	Adjusts the clamp pulse width. Narrower   Wider	Yes	No	No	No

Using handy features (Continued)

■ Cutting off the picture and sound temporarily (Mute)

When you want to project the images of another projector, overhead projector, etc. temporarily, this projector's images and sound can be turned off.

● Press the remote control's MUTE button.

The picture and sound are cut off. (The Mute function is released when pressing the MUTE button again.)

■ Notes

- The  icon will appear while mute is in effect.
- Operating any other functions will also cancel the muting.

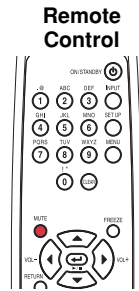

■ Freezing the image (Freeze)

The image being projected can be made to be frozen. This function is to be used to pause a video during a presentation, etc.

● Press the remote control's FREEZE button.

The picture pauses. (The Freeze function is released when pressing the FREEZE button again.)

■ Notes

- The  icon will appear while freeze is in effect.
- Other operation will also release the freeze.
- Even if an image is frozen on the projector, the pictures are running on the video or other equipment.
- If you use this function on video software sold on the market, broadcast or broadcast on cable except for the purpose of your private viewing and listening, it may infringe the copyright protected by the copyright laws.

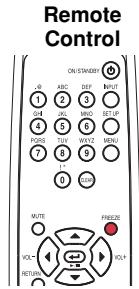

Using the menus

You can call up on-screen menus, and conduct a number of adjustments and settings using the operation buttons [p.16](#) on the control panel (main unit side) and remote control.





■ How to use the menus

The menu shown below is for operation instructions purposes and might differ from the actual display.



- 1. Press the MENU button** Display the **Setting display** menu
- 2. Select a Category**

Select a category by using .

There are following four categories:

 -  **Image adjustment menu** [p.30](#)
 -  **Display setting menu** [p.31](#)
 -  **Default setting menu** [p.32](#)
 -  **Status display menu** [p.33](#)



Displays the current adjustments and settings of selected category. Item shown with gray cannot be adjusted with the current input source.

- 3. Adjustments & Settings** Press  to open the menu.

Item Adjustment/Setting Value

These marks signify the items can be adjusted/set by using .

These marks signify that there are options. Press  to display a list of options.

These marks signify the items can be selected from the list by using . After an item is selected, apply it by pressing .

The figure shows displays given for operation instructions purposes. As the display may differ depending on the item, use the following pages as a reference.

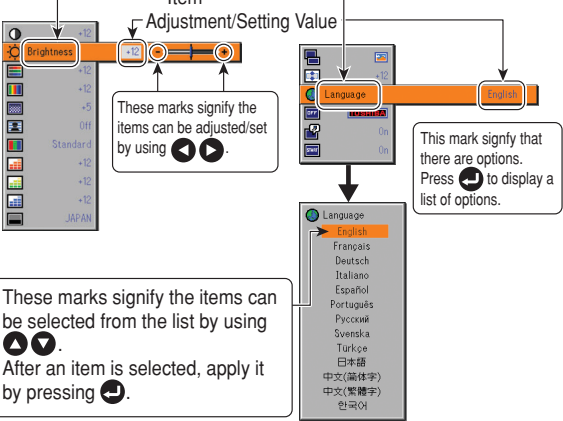
- 4. Back** Press the **RETURN** button
- 5. Press the MENU button**

The **Wireless/Card** menu appears.
* Displayed only in wireless/card input mode.

To **Wireless/Card** menu [p.36](#).

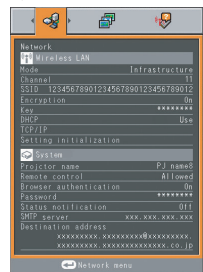
- 6. End** Press the **MENU** button
The menu disappears.

■ Note

- Menu adjustments and settings are saved when the power is turned off via the **ON/STANDBY** button. If the power cable is disconnected before this, or the power goes out, then the data will not be saved.

Using the menu (Continued)

■ The image adjustment menu

Use this menu to adjust image-related items.

Items that can be adjusted are marked with “Yes”, and those that cannot are marked with “No”.

Item	Description	Computer	Y/Pb/Pr	Video S-video	PC card
Contrast	Adjust the image contrast. Lower Higher	Yes	Yes	Yes	Yes
Brightness	Adjust the brightness of the image. Darker Brighter	Yes	Yes	Yes	Yes
Color	Adjust the color of the image. Lighter Deeper	No	Yes	Yes	No
Tint *1	Adjust the tint of the image color. Reddish Greenish	No	No	Yes	No
Sharpness	Adjust the sharpness of the image. Softer Sharper	No	Yes	Yes	Yes
Noise reduction	Set the function to reduce screen noise. On (Enable) Off (Disable)	No	Yes	Yes	No
Picture mode	Press . Toggle the picture mode with . Bright/Standard/True color	Yes	Yes	Yes	No
R-level	Adjust red of the image color. Less red More red	Yes	Yes	Yes	Yes
G-level	Adjust green of the image color. Less green More green	Yes	Yes	Yes	Yes
B-level	Adjust blue of the image color. Less blue More blue	Yes	Yes	Yes	Yes
NTSC mode *1	Set the black level with / button. US: NTSC (US) mode Japan: NTSC (JAPAN) mode	No	No	Yes	No

*1: [Tint] and [NTSC mode] can be displayed and adjusted only when the video signal is set to [NTSC] and [NTSC4.43]. (NTSC mode is set to JAPAN when the language is set to Japanese. It is set to US for other languages.)

■ The display setting menu

Use this menu to set screen display-related items.

Item	Description
Screen size	 (Full): Display with 1024 × 768 dot resolution (Thru): Display with sampling resolution (for computer input) (Wide): Wide-screen display (for Video, S-video, and Y/Pb/Pr)
Language	Select one of the languages below to use for displaying the menu and messages [: Enter setting mode] → [: Selection] → [Apply:] English/Français/Deutsch/Italiano/Español/Português/Русский/Svenska/Türkçe/日本語/中文(简体字)/中文(繁体字)/한국어
Background	Screen to display when there is no input signal (Logo) (Blue) (Black)
Icon	Display icons as function guides On Off
Start-up screen	Display start-up screen when power is turned on On Off

■ Note

- If “Thru” is selected for **screen size**, portions exceeding the native resolution (1024 × 768 pixels) will not appear on the screen. Note that for RGB signals with clock frequency 140MHz or lower, all input pixel signals are sampled. However, if the clock speed is higher than this, the RGB pixel signal is thinned before sampling.

Using the menu (Continued)

■ The default setting menu

This menu shows placement status and other settings.

Item ▲▼	Description
Projection mode	Sets projection mode in accordance with Placement Style. p.19 (Standard) (Rear) (Mounted from ceiling) (Rear mounted from ceiling)
No signal power off	Set the timer to wait for the power to be turned off after signal input stops. Press . Switch with ▲ and ▼. Off (not turned off)/ 1 min./5 min./10 min./30 min./60 min.
Auto input search	Set whether the input with signals is only selected or not. On Off
Power on	Sets whether to turn on the power when the ON/STANDBY button is pressed (Manual), or when the power cord is plugged in (Auto). Manual Auto
Lamp power ^[Note 1]	Sets the lamp power. Low Standard High
Fan mode ^[Note 2]	Sets the cooling fan speed. Standard High
Reset all	Press . Resets all adjustments and settings to their factory settings. Yes No

Notes

- When **Lamp power** is set to **Low**, the screen becomes a little darker, but the cooling fan noise gets quieter. The setting is cleared when you turn the power off, and the item is reset to **Standard** the next time you turn the power on.
- Setting **[Fan mode]** to **[High]** increases the cooling fan speed. Set this option to use the projector, for example, at high altitude (over 1,500 meters above sea level).

■ Notes

- Note that in the event of a power outage but the power is restored afterwards, the projector power will come on if **Power on** is set to **Auto**, and the power cord is plugged in.
- When you turn off the projector even if **Power on** is set to **Auto**, you must press the **ON/STANDBY** button to turn the power off.

■ Displaying Information (Status display)

This displays information about the input signal, lamp use time, etc.

“Yes”: displayed, “No”: not displayed

Item	Description	Computer	Y/P _B /P _R	Video S-video	PC card
Input	Input source name	Yes	Yes	Yes	Yes
Mode name	RGB input mode ^[Note 1]	Yes	No	No	No
H-resolution	Horizontal resolution (in dots)	Yes	No	No	No
V-resolution	Vertical resolution (in dots)	Yes	No	No	No
H-frequency	Horizontal sync frequency	Yes	No	No	No
V-frequency	Vertical sync frequency ^[Note 2]	Yes	No	No	No
Sync	Sync signal polarity ^[Note 3]	Yes	No	No	No
Signal format	Y/P _B /P _R signal format	No	Yes	No	No
Video mode	Color method of video signal	No	No	Yes	No
Lamp time	Time of lamp use ^[Note 4]	Yes	Yes	Yes	Yes
Lamp reset count	The count for lamp replacement	Yes	Yes	Yes	Yes
Total time	The total time that this projector is used	Yes	Yes	Yes	Yes
Version	Firmware version ^[Note 5]	Yes	Yes	Yes	Yes

Notes

- The mode of supported RGB signals [p.69](#) is shown.
- Same as the refresh rate of the computer signal.
- Sync signal polarity shown as P (positive) or N (negative) for [H/V].
- Displays **[Lamp time]** as a measure of when the lamp should be replaced. (Cannot be used as a counter of guaranteed lamp time.) When the displayed time approaches 2,000 hours, consult with a store about getting a TLPLW3 replacement lamp (sold separately) prepared.
- [Version]** shows the version of the projector's internal control program. This version is referred to for customer service, etc.

■ Note

- The displayed information will not be refreshed if the status changes. To refresh the information, dismiss the display, then display it again.

Setting up the wireless LAN

■ Functions

The following functions are available via wireless communications, when the wireless LAN PC card and dedicated **Wireless Utility** software [p.50](#) included with this projector are used.

Note: A wireless LAN PC card except the supplied one (or recommended by Toshiba) does not work with this product. Please ask your dealer about the available wireless LAN PC card.

1) Displaying a computer's screen via the projector

The computer's desktop screen can be sent, as well as the screens of a variety of software applications, to the projector for display.

2) Displaying an image saved on a computer via the projector

JPEG files can be sent to the projector for display.

3) Operating the projector by means of a computer

Some of the same functions available from the remote control can be performed.

■ Communication mode

This projector supports both Ad hoc and Infrastructure Communication modes.

◆ Ad hoc communication mode

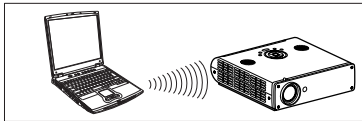

This is transmission mode to communicate between wireless LAN equipment. Wireless communication can be performed via the simple configurations. This function can only be used if the projector is in range of the computer's wireless signals.

For security reason, confirm the specifications of your computer for the distance that the radio wave can reach. The coverage of this projector may vary, depending on the computer and the surrounding environment. When tested with a PC manufactured by Toshiba with built-in wireless LAN system, the coverage is approximately 60 m with an unobstructed path between the projector and computer placed indoors. This figure is not guaranteed and should be considered as merely a guideline.

◆ Infrastructure communication mode

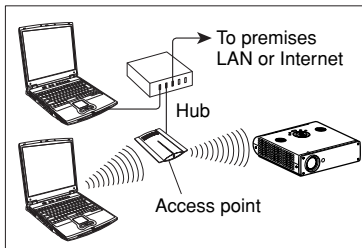

This mode allows the projector to communicate with a wireless-LAN/wired-LAN mixed network via an access point. (It even allows for communication between wireless LAN devices.) Connecting to the rest of the world via a wired LAN or the Internet generally requires a high level of security.

Use the appropriate transmission mode for your network environment.

■ Caution when using the wireless LAN functions

The Wireless LAN in this unit uses the 2.4 GHz waveband. If there is a similar wireless LAN in the area, or a wireless device using the 2.4 GHz waveband, or a microwave oven, the communication efficiency of this apparatus will be reduced, and may become unusable, but it is not a fault. If this happens, check an area away from the current location that will not cause radio interference to medical, industrial and public equipment, and change to it, or stop using the unit.

Setting up the wireless LAN (Continued)

■ Setup using the Wireless/Card menu

● Projector settings (Be sure to read this subsection.)

The factory settings can be used as-is. However, if you need higher security, the projector settings should be changed.

1. Press the MENU button twice

Display the Wireless/Card menu.
* Displayed only in Wireless/Card input mode.

2. Select a Category

Select a category by using .
The following three categories are available:

- Network setup **p.38**
- Slide Show setup **p.43**
- Status display **p.48**

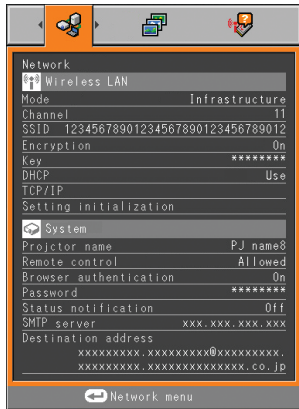

Displays the current settings of selected category.
Dimmed items cannot be changed under the current settings.

3. Make settings

Press to open the menu.

These marks signify that options can be selected by using .

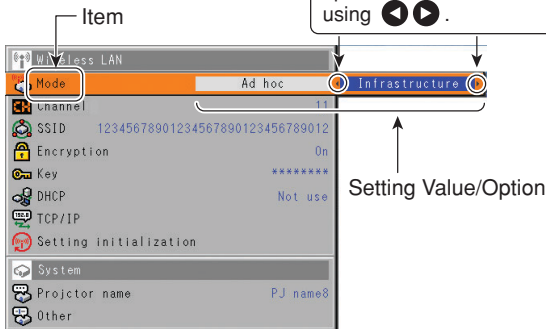

The figure shows a typical example. As the display may differ depending on the item, use the following pages as a reference.

4. Back Press the RETURN button

■ How to enter characters

Use the numeric keypad on the remote control to enter characters. Enter each character of interest and press the button to accept it.

Text input mode		
Remote control buttons	Alphanumeric character/symbol input items (Examples: SSID, Key settings)	Only-digital input items (Examples: TCP/IP settings)
1	"1" "." "@" "-" "	"1"
2	"2" "A" "B" "C" "a" "b" "c"	"2"
3	"3" "D" "E" "F" "d" "e" "f"	"3"
4	"4" "G" "H" "I" "g" "h" "i"	"4"
5	"5" "J" "K" "L" "j" "k" "l"	"5"
6	"6" "M" "N" "O" "m" "n" "o"	"6"
7	"7" "P" "Q" "R" "S" "p" "q" "r" "s"	"7"
8	"8" "T" "U" "V" "t" "u" "v"	"8"
9	"9" "W" "X" "Y" "Z" "w" "x" "y" "z"	"9"
0	"0" "space" "#\$%&'()*+,-./:;<=>?[\] ^ _ { } ~"	"0"
CLEAR	Erase one character.	Erase one character.

5. End Press the MENU button

The menu disappears.

Setting up the wireless LAN (Continued)

■ Setting up the network

If you select **Network** in step 2 in “**Projector settings**” p.36, the following items can be set.

Item	Description
Mode	Ad hoc Infrastructure
Channel	Use to select the number (1 to 11) to be set.
SSID	Specify an arbitrary character string (1 to 32 characters). [: Enter the setting mode]→[: Move from digit to digit] ↔ [: to : Enter the string]→[Accept:
Encryption	On Off
Key	Specify an arbitrary character string. (A string of 5 or 13 characters or a string of 10 or 26 characters in hexadecimal notation) [: Enter the setting mode]→[: Move from digit to digit] ↔ [: to : Enter the string]→[Accept:
DHCP	Use Not use
TCP/IP	Enter single-byte numeric characters to specify the IP address/subnet mask/gateway. [: Enter the setting mode]→[: Select an item]→[: Move from digit to digit] ↔ [: to : Enter the string]→[Accept:
Setting initialization	Initialize the wireless LAN settings. [: Enter the execution mode]→[Yes No]→[Accept:
Projector name	Specify an arbitrary character string (0 to 8 characters). [: Enter the setting mode]→[: Move from digit to digit] ↔ [: to : Enter the string]→[Accept:
Other	Remote control/Browser authentication/Password/Status notification/SMTP server/Destination address

* To enter characters, use the numeric keypad on the remote control.

■ Note

- The wireless LAN settings take effect the moment you closes the menu.

● Details on individual items

• [Mode]

Your projector is set to **Ad hoc** in the factory. Change the setting if you want to use the projector in **Infrastructure** mode.

• [Channel]

Usually, you do not have to set this item. If a network group having the same **SSID** already exists in the projector's coverage, the channel is changed automatically to the channel of that network group.

Note 1: If a set channel is in bad connections for wireless connection, try the other channels to avoid the effects of radio waves to select the one in possibly the best communication conditions.

Note 2: To communicate in Ad hoc mode with a computer that cannot change the channel, start up the projector before the computer.

• [SSID]

This is an ID code for connecting to specific individuals over a wireless LAN. This may also be called “**Network group**” or “**Network name**”. Please read the following carefully.

Note 1: The **SSID** is set to **DPJ** when shipped from the factory. If you leave this setting as it is, security may be compromised due to access by a third party using the “**Wireless Utility**” within the projector's possible communication area. Before using the projector, therefore, be sure to set **SSID** to a character string different from the default.

Note 2: When you use the Ad hoc communication mode, if there is a similar SSID network group (for example DPJ, DPJ1, DPJ2, etc.) in the possible communication area, it is possible that your projector name will not be displayed in the **Wireless Utility** projector list column. If this is the case, set **SSID** to a completely different character string.

• [Encryption]

Enable or disable encryption for security purposes.

Note: **Encryption** is factory-set to **Off**. If you use the projector with this setting left unchanged, security may be compromised due to access by a third party using the Wireless Utility within the projector's coverage. Before using the projector, therefore, be sure to set **Encryption** to **On**.

• [Key]

When you have set **Encryption** to **On**, the encryption key must be set. For use at an encryption level of **64-bit**, specify a string of 5 arbitrary characters or a string of ten characters in hexadecimal notation. For use at the **128-bit** level, specify a string of 13 arbitrary characters or a string of 26 characters in hexadecimal notation.

Note: Alphabetic characters (A to F, a to f) used in hexadecimal notation are case insensitive; the uppercase characters and their lowercase equivalents are handled to be identical.

The higher the number of bits, the stronger the encryption, and hence the harder it will be for a third party to decipher your communications. However, setting higher encryption levels may slow down communication speed. To set the highest security level, specify a **128-bit** encryption key. For higher security, avoid using a word found in a dictionary and change the key sometimes.

Set the following item if you have set the communication mode to Infrastructure.

• [DHCP]

If you set **DHCP** to **Use**, the IP address of the projector is assigned automatically by the DHCP server. If your network environment does not assign IP addresses automatically, set **DHCP** to **Not use**, then set the following item **TCP/IP** manually.

• [TCP/IP]

If you have set **DHCP** to **Not use**, ask the network administrator to check for the following items, then perform the **TCP/IP** settings manually.

• IP address

An IP address is a unique number assigned to a terminal for connection to the Internet. The format is a string of four dot-separated three-digit numbers. (Example: 111.112.xxx.xxx)

Setting up the wireless LAN (Continued)

- **Subnet mask**

A subnet mask is used to determine what subnet the IP address assigned to a terminal belongs to. (Example: 255.255.xxx.xxx)

- **Gateway**

This value specifies the device, such as a router, to be used to access servers outside the network. It is identified by the IP address. (Example: 111.112.xxx.xxx)

- **[Setting initialization]**





























This item resets the wireless LAN settings to their factory defaults.

- **[Projector name]**

This can be used to identify projectors when communicating with multiple projectors, or if there is a possibility that another person who is out of communication range will be using the same projector. It is recommended this is set to prevent wrong transmission.

- **[Other]**

This item is expanded into the following items:

Item ▲▼	Description
 Remote control	Select whether this projector is to be remote-controlled by the computer. Allowed  Presentation  Forbidden  Allowed : Always accepts remote commands from the computer. Presentation : Accepts remote commands only from the computer, the screen of which is currently being displayed via the projector by the Wireless Utility (Update automatically). Forbidden : Always ignores remote commands from the computer.
 Browser authentication	Enable or disable password authentication for access to the setting menu of the Projector Configuration Tool. On  Off 
 Password	Set the password to be made valid for access to the setting menu when [Browser authentication] is set to [On]. Specify a string of arbitrary characters (1 to 8 characters). []: Enter the setting mode → []: Move from digit to digit] ↔ [ to []: Enter the string] → [Accept: 
 Status notification	Select whether to automatically send error information to a specified e-mail address if an error occurs, for example, when the lamp has blown. On  Off 
 SMTP server	Set the IP address of the SMTP server. []: Enter the setting mode → []: Move from digit to digit] ↔ [ to []: Enter the string] → [Accept: 
 Destination address	Set the e-mail address of the recipient of the status notification, within 60 characters. (xxx@xxx.xxx) []: Enter the setting mode → []: Move from digit to digit] ↔ [ to []: Enter the string] → [Accept: 

PRECAUTIONS

- **Browser authentication** and **Password** are factory-set to **Off** and no string, respectively. You should set them as soon as possible.
- If you have forgotten your password, set it again using the menu on the main unit.

Computer settings

Refer to instruction manuals of your computer or wireless LAN PC card to perform the following settings.

- Select **Ad hoc** (for some PC cards, this is **Peer-to-Peer Group**).
- Set the **Channel** to channel assigned to the projector (in factory reset mode, this is set to **10**).
For some computers, you cannot set the channel in Ad hoc mode.
- Set **SSID** (for some types of PC card, use **Network name** instead) as the same as projector's **SSID** (at factory shipment, this is set to **DPJ**).
- If **Encryption** and **Key** are set on the projector, set to the same values.

Note: It is imperative that the projector and computer encryption settings are the same. If the settings are different, the encryption may be invalid when sending in the Ad hoc communication mode, so be careful.

Projecting images stored in a memory PC card

This projector can read JPEG files from a memory PC card to display them on the screen. This allows you to give presentations without a computer, create an advertising screen board using the slideshow function, and more. (The projector cannot reproduce animation effects such as those produced by Microsoft® PowerPoint®.)

Memory PC cards

PC card slot types

The PC card slot installed on this projector is TYPE II (PCMCIA Release 2.1)-compliant. Please use memory PC cards and conversion adapters compliant with this type of PC card slot.

Only a 3.3-V PC card can be used. (A 5-V only PC card cannot be used.)

Supported storage media types

This projector supports the following types of ATA-compliant storage media. This owner's manual refers to the combination of the ATA conversion adapter and media in use as a "memory PC card."

Storage media that can be used as-is

Flash ATA card, TOSHIBA Mobile Disk

Storage media that can be used in combination with each of the ATA conversion adapter types

SmartMedia™, CompactFlash card, SD memory card, miniSD card, MMC, memory stick, xD-Picture Card™

Note that inserting conversion adapters and memory cards with different functions than above, and other memory cards (excluding the supplied wireless LAN PC card) into the projector could damage the PC card or cause malfunctions.

Memory PC Cards Whose Operation Have Been Confirmed

Please note that presence on this list is not a guarantee of operation.

- TOSHIBA Mobile Disk: PAMHD005 (5GB), PAMHD002 (2GB)
- SmartMedia™: TOSHIBA PDR-SM32 (32MB), PDR-SM64 (64MB)
- SD memory cards: TOSHIBA SD-M512 (512MB), SD-M256 (256MB), SD-M128 (128MB)
- miniSD cards: TOSHIBA SD-S64 (64MB), SD-S32 (32MB)
- Adapters: BUFFALO MCR-5A, RXD-A

The TOSHIBA IPC5019A SmartMedia™ PC card adapter is not ATA-compliant, and so cannot be used by this projector.

Backing up data

Toshiba recommend that you back up the data on the memory PC card before use. (Toshiba assume no liability for losses incurred by data lost through the use of this projector.)

JPEG files

- (1) Supported file extensions are jpg, JPG, jpeg, and JPEG.
- (2) The maximum number including both folders and files is 512.
- (3) Some JPEG files are not supported by this projector.

The limitations in (3) above can be alleviated by converting the JPEG file with the supplied JPEG Conversion Tool [p.55](#) software application.

Setting slideshow options

Slideshow is the function to display the JPEG image files stored in a memory PC card one after another at fixed time intervals. When switching from one image to the next, Slideshow can add various display effects (transitions) to them. If you select **Slide Show** in step 2 in "Projector settings" [p.36](#), the following items can be set.

Item ▲▼	Description
PC card display	Manual ◀▶ Auto. (Select whether to automatically switch to wireless/card input when a PC card in plugged.)
Auto. demo	On ◀▶ Off (Select whether to automatically start a slide show when a PC card in plugged.)
Interval	Select the slide show display interval from among the following options using ◀▶: 5 sec./10 sec./30 sec./1 min./3 min./5 min./10 min.
Display effect	Select the type of transition for slide shows from among the following options using ▲▼◀▶: None / Wipe ↑ / Wipe ↓ / Wipe ← / Wipe → / Dissolve / Cover ↑ / Cover ↓ / Cover ← / Cover → / Checker / Zoom / Rotate zoom / Belt wipe / Blind
Play icon	Standard ◀▶ Continuous

Details on individual items

[PC card display] function

- If you set **PC card display** to **Auto.**, the projector switches to wireless/card input mode automatically when a PC card is plugged into the PC card slot. Although this item is provided as one of slideshow options, the setting works the same way even when a wireless LAN PC card is plugged into the PC card slot.
- If you set **PC card display** to **Manual**, the projector makes no response to the plugging of a PC card into the PC card slot.

[Auto. demo] function

- If you set **Auto. demo** to **On**, the projector starts a slide show automatically when it switches to the wireless/card input mode with a memory PC card plugged into the PC card slot. The slide show displays the JPEG files stored in the root directory of the memory PC card.
- If you set **Auto. demo** to **Off**, a thumbnail list [p.45](#) appears automatically on the screen when it switches to the wireless/card input mode with a memory PC card plugged into the PC card slot. Select and view desired JPEG image files.

Projecting images stored in a memory PC card (Continued)

• [Interval]

You can set the display interval of time (in seconds or minutes) for slide shows to be played automatically.

• [Display effect]

When playing a slide show, the projector can give various display effects or transitions to each slide being displayed.

The transitions available are listed below:

• None

Display each slide normally.

• Wipe

Display the next slide gradually upward (Wipe ↑), downward (Wipe ↓), to the left (Wipe ←), or to the right (Wipe →), over the current slide.

• Dissolve

Display the next slide gradually in a certain fixed block pattern over the current slide.

• Cover

Display the next slide as sliding upward (Cover ↑), downward (Cover ↓), to the left (Cover ←), or to the right (Cover →), over the current slide.

• Checker

Display the next slide gradually from the left using checkered blocks over the current slide.

• Zoom/Rotate zoom

Display the next slide by enlarging it gradually, either straight from the center (Zoom) or while turning it starting from the center (Spin zoom), over the current slide.

• Belt wipe

Display the next slide gradually in stripes from both sides, over the current slide.

• Blind

Display the next slide, as if it opened like a window blind, over the current slide.

• [Play icon]

The slideshow icon can be displayed.

• Standard

The projector handles the slideshow icon as follows depending on the “On/Off” setting of **Icon** on the projector’s menu.

Icon On: The projector displays the icon upon the start of playing a slide show and turns it off after a few seconds.

Icon Off: The projector does not display the icon.

• Continuous

The projector keeps the icon displayed during the slide show.

■ Automatic demonstration

If you set **Auto. demo** to **On** in “**Setting slideshow options**” [p.43](#), the projector starts a slide show automatically when it switches to the wireless/card input mode with a memory PC card plugged into the PC card slot according to the procedure in “**Mounting a PC card**” [p.21](#).

- The slide show is played as set in “**Setting slideshow options**”.
- The slide show displays the JPEG files stored in the root directory of the memory PC card.
- If you set **PC card display** to **Auto**, the projector starts a slide show automatically when the power is turned on with a memory PC card plugged.
- To suspend the slide show, press the  button. Pressing it again resumes the slide show.
- To end the slide show, press the RETURN button. A thumbnail list will then be displayed.

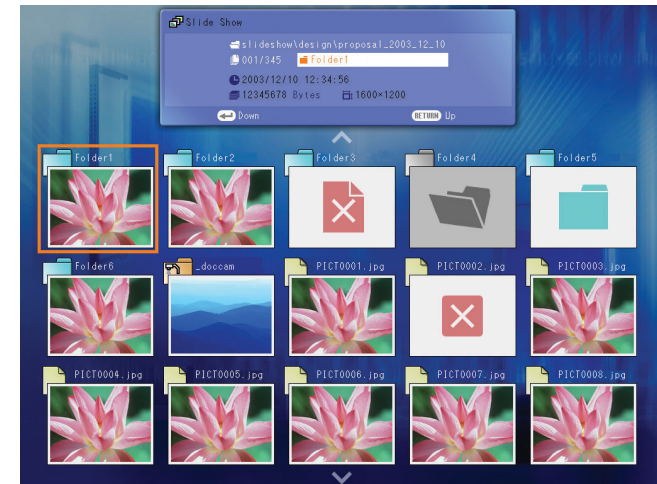

Projecting images stored in a memory PC card (Continued)

■ Playing a slide show from a thumbnail list

① Plugging a memory PC card.

If you set **Auto. demo** to **Off** in “**Setting slideshow options**” [p.43](#) and plug a memory PC card into the PC card slot according to the procedure in “**Mounting a PC card**” [p.21](#), the projector starts loading data from the PC card to display a thumbnail list on the screen when the projector switches to the wireless/card input mode. The screenshot below is an example of the thumbnail list. The actual list will vary depending on the data stored on your memory PC card.

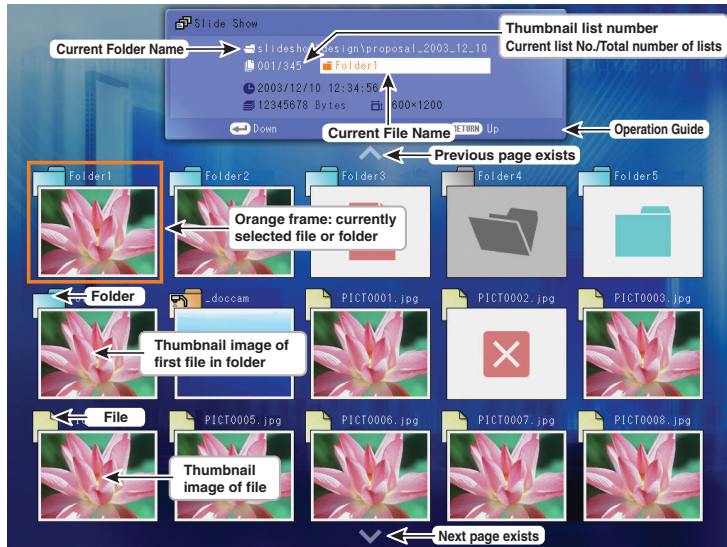

Symbols in the thumbnail list



Indicates that only folders are inside the folder.



Indicates that there is no data to be displayed in the folder.



Indicates that the JPEG or other file is not supported.



Indicates that an unsupported JPEG or other file is present.

② Searching for a target file

- Use the buttons to move the orange frame over the desired file or folder.
- If there are multiple pages of thumbnails, click the button on the bottom row to go to the next page, and the button on the top row to go to the previous page.
- To open a folder, move the orange frame to the desired folder and press the button. You can navigate down up to 5 levels using the same procedure. Pressing the RETURN button returns you to the next or other upper level folder.

③ Displaying slides

- Pressing the button with a file selected displays the image in that file only in full-screen view on the screen as a slide. Pressing the button enters the automatic play mode.
- To return to the thumbnail list display screen, press the RETURN button.

④ Changing slides

Pressing the buttons with a slide displayed changes slides.

(: previous slide; : next slide. These buttons are not available during an automatic play.)

⑤ Rotating a slide

Pressing the buttons with a slide displayed rotates the slide 90 degrees. The rotation information is preserved as long as you remain in the current folder.

(: Rotate left; : Rotate right. These buttons are not available during an automatic play.)

■ Notes

- The thumbnail display order and slide order goes in order from shortest file name to longest. If two file names have the same number of characters, they are ordered numerically if numbers are used in the file name, and alphabetically otherwise.
- It is possible to give presentations without using a computer by converting presentations created with Microsoft® PowerPoint® into JPEG files using the **JPEG Conversion Tool**, and storing them on a memory PC card. [p.57](#)
Note, however, that functions such as animation effects and hyperlinks cannot be used, so it should be tested before the actual presentation.

Checking the projector status

■ Status display

To check the current status of the projector, select **Status display** in step 2 in “**Projector settings**” [p.36](#). The following items of information will then be displayed.

<Application> The name of the application currently running on the projector is displayed. (Examples: Slide Show, Wireless Utility)
<PC card> When no card is plugged → “Type” is displayed. When a memory PC card is plugged → “Type/Free space/Status” are displayed. When a wireless LAN PC card is plugged → “Type/MAC address/DHCP/IP address/ Subnet mask/Gateway” are displayed.
<Version> The firmware version number of the wireless/card feature is displayed.

■ Note

- This product contains a piece of software (hereafter the Software) licensed to TOSHIBA CORPORATION (hereafter TOSHIBA) by AXE, Inc. (hereafter AXE). The copyright and other intellectual property rights of the software are held by AXE or the licensor. The software is protected by the Copyright Law, Universal Copyright Convention, and other intellectual property laws and agreements. The permission of AXE or the licensor must therefore be obtained before the software can be reproduced. Note, however, that the software is partly covered under the GNU General Public License Version 2 (hereafter GPL2). You can obtain a copy of GPL2 at <http://www.fsf.org/copyleft/gpl.html>. AXE will provide the GPL-covered source code of the software in accordance with the terms of GPL2. Contact AXE if you need it.

An OS of axLinux is a registered trademark of AXE, Inc.

Installing the applications

If you will use the wireless LAN PC card function, install the application on the supplied CD-ROM onto your computer.

■ System Requirements

Supported OS:	Windows® 2000, Windows® XP
CPU:	Pentium III 750 MHz or higher recommended
RAM:	256 MB or more recommended
Screen area (resolution):	1024 by 768 pixels recommended

■ Application Types and Major Functions

Wireless Utility

This application is used for wireless connections. Use it to send the images from the computer's screen to your projector, and display on the screen.

JPEG Conversion Tool

Use to convert JPEG and other files into a format that can be displayed as a slide show using a memory PC card.

■ How to install

In the supplied CD-ROM, select the **Applications** folder, and run **setup.exe**. Follow the instructions on your computer screen.

During the installation, a dialog box may appear with the message “**Digital Signature Not Found**” and the prompt “**Do you want to continue the installation?**”. Click on the [Yes (Y)] button to continue the installation.

When installation is finished, the following shortcuts will appear on your computer's desktop:

Wireless Utility →  Operations [p.50](#)

JPEG Conversion Tool →  Operations [p.55](#)

■ How to uninstall

Select [Start Menu] → [Settings] → [Control Panel] → [Add/Remove Programs], and remove **Toshiba Data Projector** from currently installed programs.

■ Note

- Your computer screen may temporarily go out during installation, but it is not an error.

Using the Wireless Utility

■ Displaying a computer's screen via the projector

1 Launch the Wireless Utility software application.

When the **Wireless Utility** launches, the **Screen Image** transmission mode window appears on the computer screen.

To switch to the **Screen Image** transmission mode window from another mode (**File** or **Projector Camera**), click on the **Screen Image** icon .

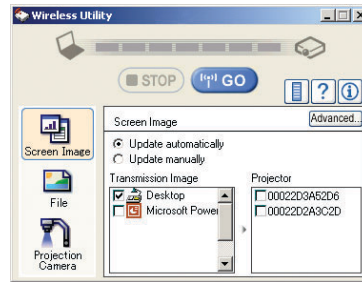

2 Select Transmission mode.

Click on **Update automatically** or **Update manually**. See step 6 for the meanings of **Update automatically** and **Update manually**.

3 Click on the Advanced button.

The **Screen Image: Advanced Settings** dialog appears. Set the dialog as shown below, as necessary.

• Interruption

Check the **No Interruptions** checkbox to prevent other computers from interrupting the projector, for example, during presentation in the **Update automatically** mode.

• Window

Select the **Place in Tasktray at the start of transmission** checkbox to iconify the **Wireless Utility** and place it in the computer's tasktray when transmission initiated.

To display the window, double click on this icon, or right click and select **Open** from the popup menu. Even with the **Wireless Utility** window minimized, you can use the pop-up menu to stop or resume transmission as described in step 4 and later

• Mode

Selecting **High quality** improves the quality of the projected image, but lowers communication speed. Selecting **High speed** has the opposite effect.

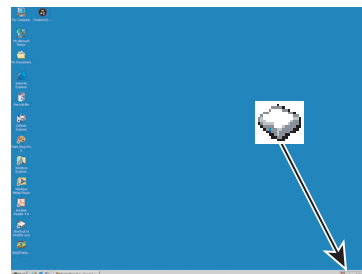
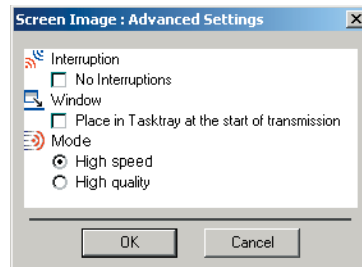

4 Select the screen image you wish the projector to display.

Select Desktop

The computer screen image is transmitted as-is.

Select application window

Select a running application (e.g. Microsoft® PowerPoint®), and send that application's window only.

The desktop and a list of running applications are displayed. Select the desired application from this list. (If the desired application is not on the list, launch it. Note that if too many applications are running, it will consume the computer's resources, which could slow communication speed.)

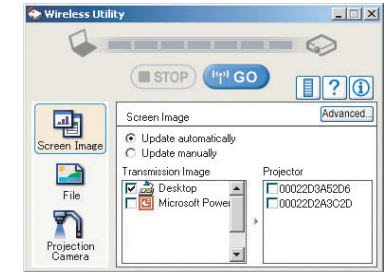

5 Select the projector to be transmitted.

The IDs of projectors accessible for communication will be listed. (When a projector name is set, that name appears instead of MAC address.) Select the checkbox of the projector you wish to transmit to from this list. Then icon  is displayed on the projector's screen for few seconds. It is possible to select up-to four projectors.

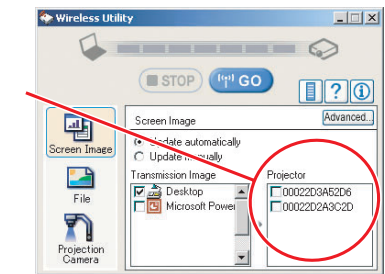

6 Click on the GO button.

When **"Update automatically"** is selected in step 2

Screen images are sent consecutively after the **GO** button is clicked.

When **"Update manually"** is selected in step 2

A single screen image is sent when the **GO** button is clicked.

7 To halt transmission from Update automatically, click on the STOP button.

If the **Wireless Utility** icon has been placed in the tasktray, double click on the icon to display the window, then halt transmission, or right click on the icon, and halt transmission.

■ Notes

- It may not be possible to transmit the images from movie player or other video applications.
- When using **"Update automatically"**, the transmitted image refresh rate depends on the performance of the computer you are using and the surrounding radio wave environment.
- The projector screen may have a few differences from the computer screen.
- It is not possible to transmit to a projector that is already receiving from another computer.
- If you selected application window in step 4, if that application is not active (in use), the image may not be correctly displayed by the projector.
- The projector ID is the MAC address of the wireless LAN PC card inserted into the projector.

Using the Wireless Utility (Continued)

■ Displaying a JPEG image saved on a computer via the projector

1 Launch the Wireless Utility software application.

The **Screen Image** transmission mode window appears on the computer's screen.

2 Click on the File icon .

The **Wireless Utility** window changes to **File** transmission mode.

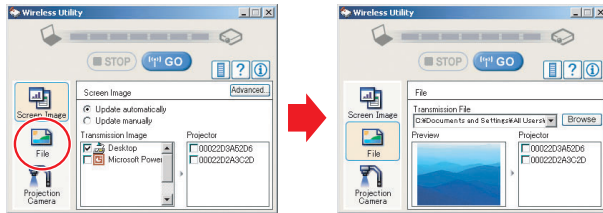

3 Click on the Browse button, and select the file to send.

Clicking on the **Browse** button displays the **Open** dialog box. Select the file to send, then click on the **Open** button.

The selected file is added to the pull-down list in the **Wireless Utility's** **Transmission File** field.

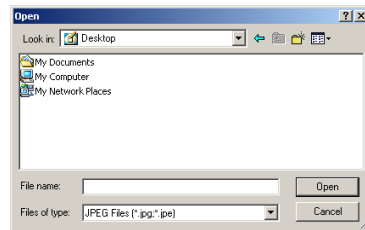

4 Select the file to be sent from the pull-down list of the Transmission File field.

Click on the **Transmission File** field's  button to display the pull-down list. Select the file to be sent from this list.

A thumbnail of the selected file appears in the **Preview** box. The file displayed here will be transmitted.

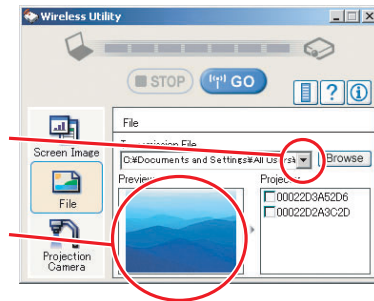

Step 3 can be skipped.

The way that drag and drop the file to be sent from the desktop or Windows Explorer into the **Preview** box is also available. In this case as well, the selected file is added to the file pull-down list **Transmission File** field's.

5 Select the projector to be transmitted.

The IDs of projectors accessible for communication will be listed. (If projector name has been set up already, it is shown instead of the MAC address.) Select the checkbox of the projector to be transmitted to from this list. Then icon  is displayed on the projector's screen for few seconds. It is possible to select up-to four projectors.

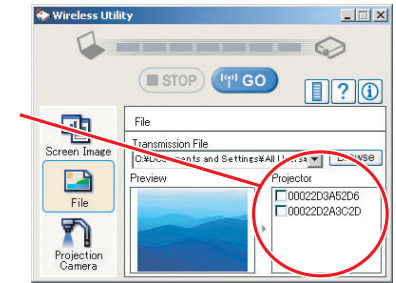

6 Click on the button.

The selected file's image is displayed by the projector.

■ Note

- Only one file can be sent at a time. To send another file, repeat steps 4 and 6.

■ Operating the projector

This function can be used with any projector input.

Note, however, that this will not function with a memory PC card.

1 Launch the Wireless Utility software application.

The **Screen Image** transmission mode window appears on the computer's screen.

2 Click on the Remote Control button.

The **Remote Control** window appears.

As the **Wireless Utility** window is still displayed, you can operate the projector via the **Remote Control** window, while using the **Wireless Utility's** functions.

While it is possible to use this function merely to operate the projector, closing the **Wireless Utility** also closes the **Remote Control** window.

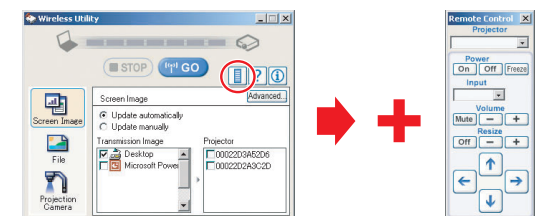

Using the Wireless Utility (Continued)

3 Select the projector to be operated.

In the **Remote Control** window, click on the ▾ button, and select the desired projector from the pull-down list. The remote control screen will then change to the new one as shown on the right. Only one projector can be selected. (It is not possible to operate multiple projectors.)

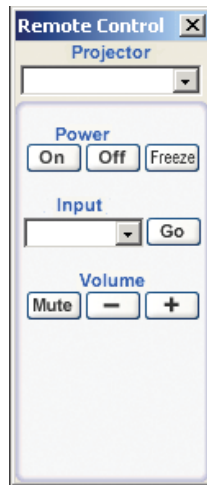

4 Click on the Remote Control window's buttons.

The function of each button and box is as follows:

Power On: Turns projector power on.

Power Off: Turns projector power off.

Input (box): Click on the ▾ button, and select the desired input from the pull-down list.

Go: Switches to the input selected in the Input box.

Freeze: The picture is paused.

Mute: Cuts off picture and sound. Click again to restore picture and sound.

+/-: Adjust sound volume.

5 To quit, click on the [X] button on the Remote Control window.

Performing this does not close the **Wireless Utility** window.

To exit both the **Wireless Utility** and the **Remote Control**, click on the [X] button on the **Wireless Utility** window.

Note

- Remote control's functions can be restricted by setting Remote control [p.40](#).

Document camera function

The document camera function is available for the Toshiba LCD data projector TLP-T701/T721/T501/T521/T521E.

For details, consult your local dealer.

How to use the JPEG Conversion Tool

The **JPEG Conversion Tool** converts JPEG files not supported by the projector, image files in other formats, Microsoft® PowerPoint® files, and the like into JPEG files supported by the projector. The JPEG files converted with this tool can be displayed by sending them using the wireless LAN PC card [p.52](#), or saving them on a memory PC card [p.42](#).

■ Launching the JPEG Conversion Tool

The window shown in the figure to the right appears on the computer screen.

Drag the **Image Quality Settings** slider to the left or right to set the image quality of the file after conversion. Lower values create smaller files, but lower the image quality. (It is not possible to restore the quality of an image after it has been lowered.)

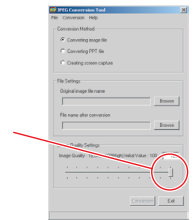

■ Converting an image file

This converts JPEG files using compression formats not supported by the projector, Windows® metafiles (wmf), and bitmapped files (bmp) into JPEG files.

- In the **Conversion Method** field, select **Converting image file**. (Status on launch)
- In the **File settings** field, click on the **Browse** button for **Original Image File Name**. The **Open** dialog box appears.
- In the **Open** dialog box:
 - Specify the location of the file to be converted; and
 - In the **Files of Type** field, click on the ▾ button to select the file format. A list of files of that format appear in the **Open** dialog box.
- In the **Open** dialog box, select the file to convert, then click on the **Open** button.
- In the **JPEG Conversion Tool** window, in the **File settings** field, select **Browse** for **File name after conversion**. The **Save As** dialog box appears.
- In the **Save As** dialog box:
 - Specify the location in which to save the converted file;
 - Enter a file name of up to 8 characters in the **File Name** field; and
 - Press the **Save** button.
- In the **JPEG Conversion Tool**, click on the **Conversion** button.
 - A confirmation dialog box opens. Click **Yes**. The computer converts the file. When it finishes a message appears informing you that a **JPEG file has been created**.

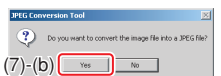
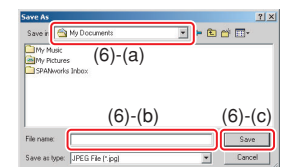
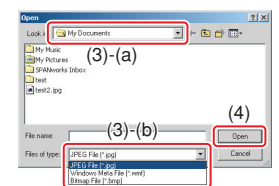
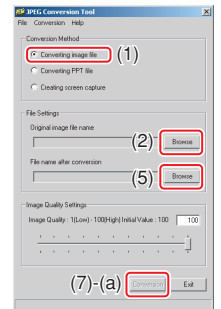

How to use the JPEG Conversion Tool (Continued)

■ Converting files created with Microsoft® PowerPoint®

This process provides presentations without using a computer by converting presentation files created with Microsoft® PowerPoint® into JPEG files, storing them on a memory PC card, and displaying them in a slide show.

- To use this conversion mode, Microsoft® PowerPoint® must be installed on the computer.
- Only static images are supported by this process. Animation and audio are not supported.

Presentation files created with Microsoft® PowerPoint® usually consist of several slides. For this reason, the tool creates a folder with the name specified in step (5), below, and file for each slide is created in the folder (starting with slide001.jpg).

- (1) In the **Conversion Method** field, select **Converting PPT file**.

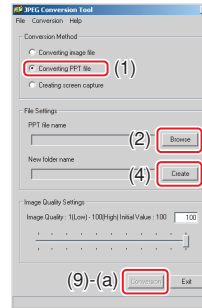

- (2) In the **File settings** field, click on the **Browse** button for **PPT File Name**.

The **Open** dialog box appears.

- (3) In the **Open** dialog box:

- (a) Specify the location of the file to be converted; and
- (b) Select the PowerPoint® presentation file to convert, then click on the **Open** button.

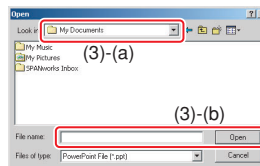

- (4) In the **JPEG Conversion Tool** window, in the **File settings** field, click on the **Create** button for **New folder name**.

The **Folder create** dialog box appears.

- (5) In the **Folder create** dialog box, in the **Folder Name** of document field, specify a folder name of 12 characters or less.

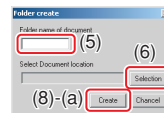

- (6) In the **Folder create** dialog box, click on the **Selection** button.

The **Browse for Folder** dialog box appears.

- (7) In the **Browse for Folder** dialog box:

- (a) Specify the location in which to save the folder; and
- (b) Click on the **OK** button.

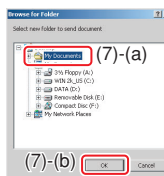

- (8) In the **Folder create** dialog box:

- (a) Click on the **Create** button.
- (b) Click on the **OK** button.

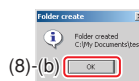

- (9) (a) In the **JPEG Conversion Tool** window, click on the **Conversion** button.

- (b) A confirmation dialog box opens. Click **Yes**.

The computer begins to convert the file. When it finishes, a message appears informing you that a **JPEG file has been created**.

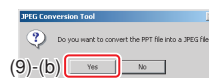

■ Making a presentation with converted JPEG files

- (1) Copy the folder created by the **JPEG Conversion Tool**, or its contents, onto a memory PC card.
- (2) Use the step 1 in **“Playing a slide show from a thumbnail list”** p.46 to display a list of thumbnails.
- (3) Follow the instructions in step 2 in **“Playing a slide show from a thumbnail list”** p.47 to find the thumbnail of the first slide, Slide001.jpg, and move the orange frame to it. (Select Slide001.jpg.)
- (4) Press the **Play** button on the remote control. An enlarged view of the first slide appears on the screen. This starts the presentation.
- (5) To continue to the next slide, press the remote control’s **Next** button. To go back to the previous slide, press the **Previous** button.

■ Creating a screen capture and converting it into a JPEG file

This function saves the current computer screen as a JPEG file.

- (1) In the **Conversion Method** field, select **Creating screen capture**.

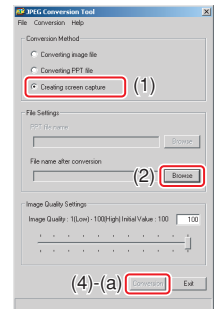

- (2) In the **File settings** field, click on the **Browse** button for **File name after conversion**.

The **Save As** dialog box appears.

- (3) In the **Save As** dialog box:

- (a) Specify the location in which to save the converted file;
- (b) Enter a file name of up to 8 characters in the **File Name** field; and
- (c) Click on the **Save** button.

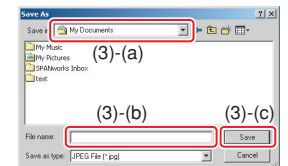

- (4) (a) In the **JPEG Conversion Tool** window, click on the **Conversion** button.

- (b) A confirmation message appears. Click **Yes**. The computer creates a screen capture, and converts it into a JPEG file in the specified location. When it is finished, a message appears to tell you that a **JPEG file has been created**.

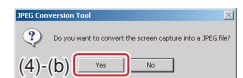

■ Note

- The maximum resolution of JPEG files created with the JPEG Conversion Tool is 1,024 x 768 pixels.

Setting up the projector using a Web browser

■ How to use the “Projector Configuration Tool”

The “Projector Configuration Tool” uses the Web server features of the projector to set up the projector using a wireless LAN PC card.

When using the “Projector Configuration Tool”, set up the wireless LAN connecting the projector and the computer.

1 See “Checking the projector status” p.48 to display information on the screen and write down the IP address.

2 Invoke Internet Explorer.

Internet Explorer Ver. 5.0 or later is recommended. Enable the Javascript functions.

3 In the address bar, enter the IP address “http://xxx.xxx.xxx.xxx/” recorded in step 1 above.

The Web browser will then display the following page.

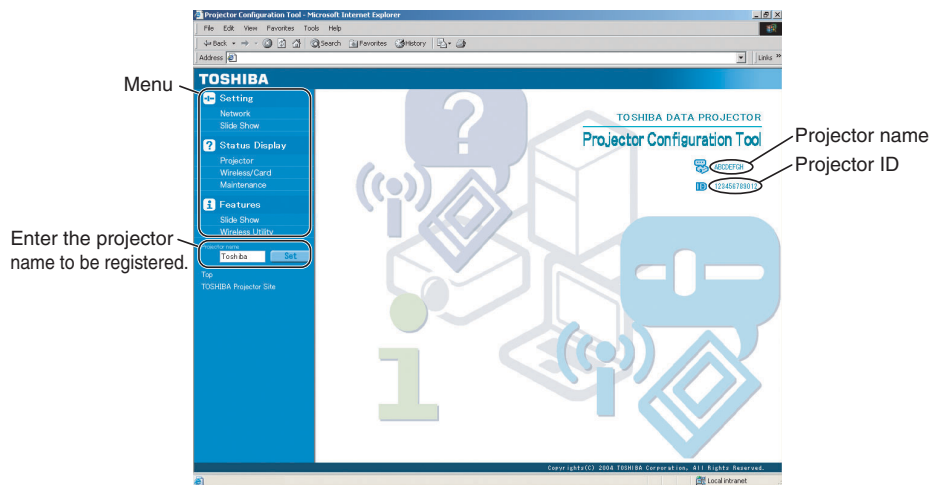

Note 1: To prevent access from third parties, the projector is restricted to permit access only from the computer that has been set up for the TCP/IP to have the same network address as the projector.

Note 2: If you use a proxy server, do not enable the proxy when accessing the above IP address.

The TCP/IP settings for the projector and computer are required even in the wireless LAN Ad hoc mode.

4 Select items from the menu on the left.

- Setting:** Allows you to make various settings on the wireless/card menu. When **Browser authentication** has been set to **On**, access to the setup page requires the input of the password.
- Status Display:** Displays some states of the projector.
- Features:** Introduces the functions available in wireless/card input mode.
- Projector name:** Enter a character string and press the **Set** button, and it will be set as the projector name.
- Top:** Returns you to the top page.
- TOSHIBA Projector Site:** The browser will display the home page at <http://multimedia.projector-toshiba.com/map.html>, providing projector information. The home page address is subject to change without notice.
(The Toshiba's web site can be browsed only when your computer can access the Internet.)

● Details on major items

• Setting

Allows you to make various settings on the wireless/card menu. When **Browser authentication** has been set to **On**, access to the setup page requires the input of the password.

Network: The items available here are equivalent to those in the wireless/card menu. Note, however, that security items such as “**Remote control**” and “**Browser authentication**” cannot be set. Entering individual items and press the **Execute** button to update their setting.

Slide Show: The items available here are equivalent to those in the wireless/card menu. Entering individual items and press the **Execute** button to update their setting.

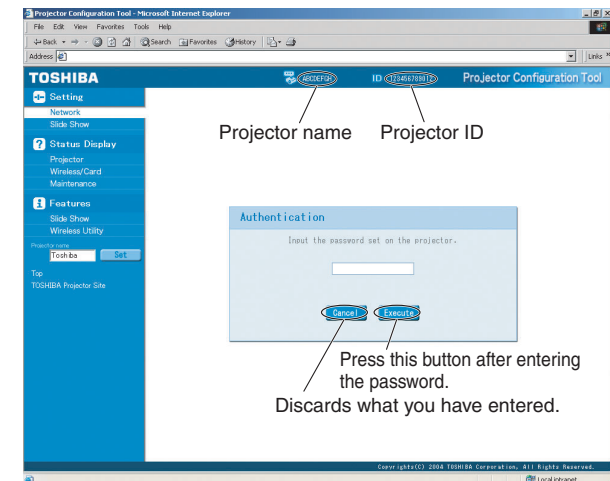

Setting up the projector using a Web browser (Continued)

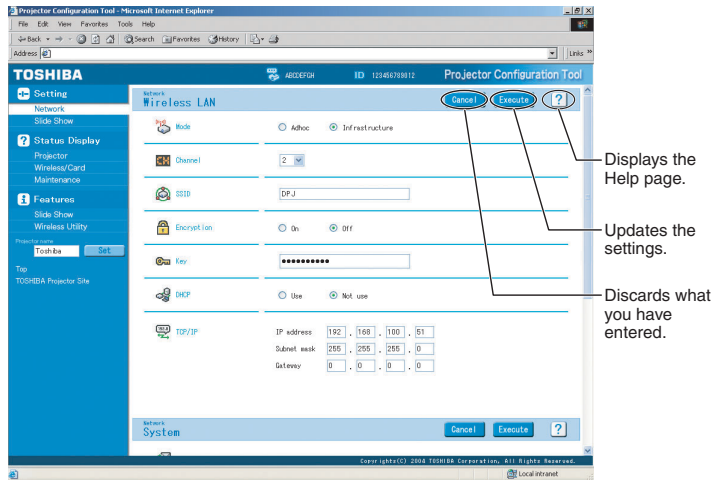

Enter single-byte alphanumeric characters in text input fields.

• Status Display

Displays some states of the projector.

Projector: Displays the contents of status display in the menu.

Wireless/Card: Displays the contents of status display in the Wireless/Card menu.

Maintenance: Describes an error if it occurs, for example, when the lamp has blown.

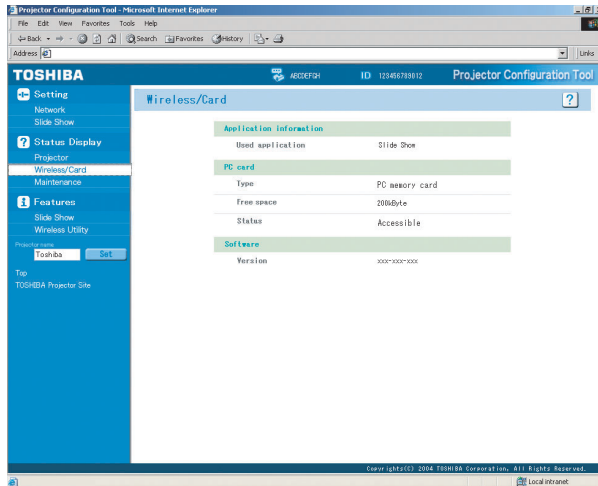

• Features

Introduces the functions available in Wireless/Card input mode.

Slide Show

Wireless Utility

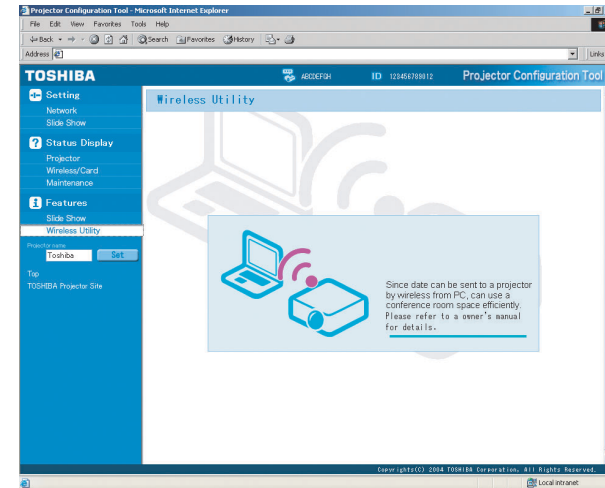

About lamp

The product's light source is a mercury lamp that lights at increased internal pressure. Be sure to fully understand the following characteristics of the lamp and handle it with extreme care.

- The lamp may explode with a loud noise due to impact or deterioration, or fail to light at the expiration of its life.
- How long it takes before the lamp explodes or the life expires may vary greatly by lamp. Some may explode shortly after first use. (Free replacement is available if the lamp explodes within the warranty period. Contact the dealer from whom you purchased the product in such a case.)
- Explosion is likely to happen if the lamp is used after the replacement period has elapsed.
- When the lamp explodes, the broken pieces of glass may get inside the product or be released outside from the openings for ventilation.
- When the lamp explodes, a slight amount of mercury gas enclosed in the lamp along with glass dust may be released from the openings for ventilation.

■ Immediately replace the lamp when a sign appears on the screen.

- When the replacement time approaches, a message will appear on the screen.
- The risk of explosion will increase if the lamp is continuously used without being replaced.
- Frequently check the used hours and prepare spares when the replacement time approaches. (Refer to “**Status display**”. [p.33](#).)

■ When the lamp is broken

- If glass components, including a lamp and a lens, should break, handle the broken pieces with care to avoid injury and contact your dealer for repair service.
- In the event of lamp explosion, unplug the product from the wall outlet, leave and completely ventilate the room. Then, thoroughly clean the area around the projector and discard any edible items placed in that area.
- When the lamp explodes, consult a doctor if glass dust or mercury gas gets into your eyes or you breathe it.

Lamp replacement

A lamp is consumable supplies. If used for extended periods, images will appear dark, and the lamp could burn out. This is characteristic of a lamp, and is not malfunction. (The lifetime of the lamp depends on condition of use.) If this happens, replace it with a new one.

⚠ WARNING

- If the projector is mounted on a ceiling, request a lamp replacement from your projector dealership.
- When replacing, always use lamp “TLPLW3” (sold separately).

⚠ CAUTION

- If you have been using the projector, the lamp will be very hot, and may cause burn injuries. Wait for the lamp to cool (for longer than 1 hour) before replacing it.
- If the lamp should break, please handle with care to avoid injury due to broken pieces and contact your dealer for repair service.

① Unplug power cord.

② Wait until lamp is sufficiently cooled.

Wait for at least 1 hour.

③ Remove the lamp cover.

Loosen the 1 screw, then pull up to the direction of the arrow with your fingers as shown to remove the lamp cover. Use care to avoid any damage to nails and/or tip of your finger(s). (If you have any difficulty in removal, you can use a screwdriver or any other smaller tool for your convenience.)

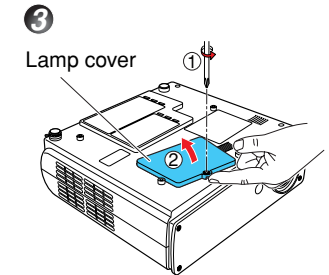

④ Pull out the lamp.

Loosen the 2 screws holding the lamp in place, and pull up the handle to remove the lamp.

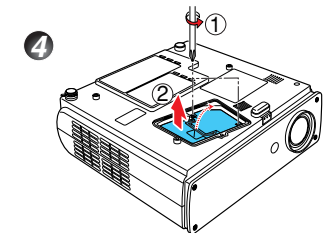

⑤ Mount the new lamp.

Align the orientation, press down until the bottom is reached, and lock in place using the two lamp locking screws.

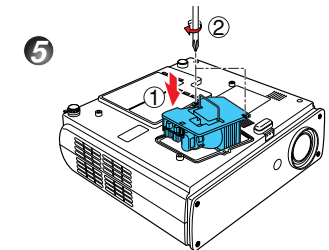

⑥ Replace the lamp cover.

Align the cover, and press it in, then tighten the screws loosened in step ③ until the lamp cover is no longer loose.

⑦ Reset the lamp timer.

See the lamp's manual for instructions on resetting the lamp timer.

■ Notes and Precautions

- **Lamp time** in the **Status display menu** indicates lamp uptime (reference value) [p.33](#).
- It is recommended that the lamp be replaced after 2,000 hours of use. When **Lamp time** reaches 2,000 hours, the icon and a message will appear. This display disappears when you press button.
- Attach the lamp cover correctly so that it is not loose. If it is not attached correctly, the lamp may fail to come on [p.65](#), and the lamp's lifetime may be shortened.
- Always replace the lamp with a new one.
- The lamp is made out of glass. Do not touch the glass surface with your bare hands, bang it, or scratch it. (Dirt, jolts, scratches and the like could break the lamp.)

Lamp replacement (Continued)

Used Lamps

This projector's lamps contain trace amounts of environmentally harmful inorganic mercury. Be careful not to break used lamps, and dispose of them in accordance with local regulations.

Lens and main unit cleaning

WARNING

- Request cleaning and maintenance of a ceiling-mounted unit from your projector dealership. Attempting to clean/replace the lamp at a high site by yourself may cause you to drop down, thus resulting in injury.

Lens cleaning

- Clean the lens with a commercially available blower and/or lens cleaner.
- The lens is easily scratched, so do not rub it with hard objects, or strike it.

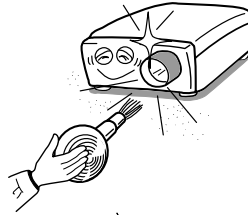

Main unit cleaning

- Clean the main unit after unplugging the power cord.
- Wipe dirt off the main unit gently with a soft cloth.
- If the soiling is severe, dip the cloth in a neutral detergent diluted in water, wring well, and gently wipe off the dirt, then finish up by wiping with a dry cloth.

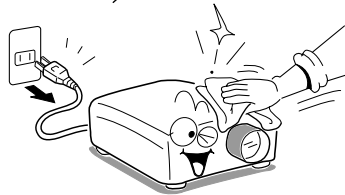

Replacing cooling fans

To maintain the performance, it is recommended that cooling fans should be replaced about every 2 to 3 years. Consult with your dealer for details.

Trouble indications

The indicator lights inform you of internal abnormalities.

	<p>No power</p> <p>⇒ Problem with projector</p> <ul style="list-style-type: none"> Unplug the power cord, and contact your dealer. The lamp cover is not properly attached. Unplug the power cord, and reattach the lamp cover. p.63
	<p>Lamp went out during use, or won't come on</p> <p>⇒ Lamp temperature is high so that it is difficult to turn on, the lifetime of the lamp has ended or the projector is malfunctioning.</p> <ul style="list-style-type: none"> Unplug the power cord and wait for a short while, then turn the power back on. If a lamp burns out, replace it with a new one. <p>※ After approx. one minute of abnormal display, the projector returns to the standby state waiting for internal cool down.</p>
	<p>Power went out during use</p> <p>⇒ Internal overheating, or the outside temperature is too high.</p> <ul style="list-style-type: none"> Place the projector so that the air intake and exhaust are not blocked. Unplug the power cord and wait for a short while, then turn the power back on. <p>※ The icon will appear before the power goes out.</p> <p>※ After approx. one minute of abnormal display, the projector returns to the standby state waiting for internal cool down.</p>
	<p>Power went out during use</p> <p>⇒ Problem with internal cooling fan.</p> <ul style="list-style-type: none"> Unplug the power cord, and contact your dealer. <p>※ The icon will appear before the power goes out.</p> <p>※ After approx. one minute of abnormal display, the projector returns to the standby state waiting for internal cool down.</p>
	<p>Power went out during use</p> <p>⇒ Problem inside the projector.</p> <ul style="list-style-type: none"> Unplug the power cord and wait for a short while, then turn the power back on. If the above action will not clear the problem, unplug the power cord, and contact your dealer. <p>※ After approx. one minute of abnormal display, the projector returns to the standby state waiting for internal cool down.</p>

PRECAUTION

- Make sure to unplug the power cord if something goes wrong.

Before calling service personnel

If you think something is wrong, check the followings before contacting customer service. Please see “**Trouble indications**” [p.65](#) as well.

If This Happens	Check
No power	<ul style="list-style-type: none"> Is the power cord plugged in? Is it connected to the projector? Is the lamp cover loose? p.63
Power goes out during use	<ul style="list-style-type: none"> Is the ambient temperature high? p.65 Is the air intake or air exhaust blocked? p.65
No picture	<ul style="list-style-type: none"> Is the projector turned on? p.24 Is the mute function on? p.28 Is the brightness setting minimized? p.30 Are the connections set up correctly? p.20 Are all the connected devices functioning properly?
No audio	<ul style="list-style-type: none"> Is the projector turned on? p.24 Is the mute function on? p.28 Is the volume setting minimized? p.25 Are the connections set up correctly? p.20 Are all the connected devices functioning properly?
Picture not displayed correctly	<ul style="list-style-type: none"> Is the input signal supported by the projector? p.69, p.70 Is there something generating an abnormal video signal, for instance the video tape?
Picture blurred Part of picture out of focus	<ul style="list-style-type: none"> Is the lens dirty? p.64 Is the lens focus adjusted optimally? p.25 Is the projection distance within the projector's supported range? p.19 Is the projector's screen placement angle tilted too far? p.19 Are the sharpness or sampling phase adjustments off? p.27 p.30
Image is dark	<ul style="list-style-type: none"> Are the brightness or contrast adjustments off? p.30 Is the lamp nearing the end of its service life? p.33
Colors too light Bad shading	<ul style="list-style-type: none"> Are the color, tint, R-level, G-level, or B-level adjustments off? p.30 Is the screen dirty? Is the lamp nearing the end of its service life? p.33
Remote control doesn't work	<ul style="list-style-type: none"> Are the remote control's batteries drained? Are the batteries inserted into the remote control correctly? p.18 Is the remote control being used within the effective range? p.18 Are there any obstructions between the remote control and projector? Are there any fluorescent or other bright lights shining at the projector's infrared remote sensor?

If This Happens	Check
Memory PC card images aren't projected	<ul style="list-style-type: none"> Is the memory PC card inserted correctly? Is a PC card not supported by the projector inserted? p.42 Is the CARD indicator red? p.21 Are there any JPEG files saved on the memory PC card? Are the files too large or in an unsupported format for the projector? Convert them with the supplied software application. p.55
The wireless LAN PC card doesn't work	<ul style="list-style-type: none"> Is the wireless LAN PC card inserted correctly? Is a wireless LAN PC card not supported by the projector inserted? The operation of cards other than the supplied product is not guaranteed. Is the CARD indicator red? p.21 Are the transmission mode and channel properly configured? p.38 Are there any obstructions between the computer and projector? Do your computer and OS support the supplied software application? p.49

Specifications

■ List of general specifications

Item	Specification	
Consumption Power	300 W	
Weight	2.9 kg	
External Dimensions (including protruding parts)	298 × 101.4 × 275.4 mm (W × H × D)	
Cabinet material*	PC+ABS resin and ABS resin	
Conditions for usage environment	Temp: 5°C to 35°C; relative humidity: 30% to 70%	
Display pixels	1 chip DMD™	
Picture elements	786,432 pixels (1024H × 768V)	
Lens	Zoom lens F=2.4-2.65 f=28.04-35.59 mm	
Lamp	High-pressure mercury lamp	
Projection screen size	24.6-246 inches	
Projection distance	1.20-10.00 m	
Speaker	1 W (Monaural)	
Connection terminal	COMPUTER-1 terminal	Mini D sub 15 pin RGB / Y/P _B /P _R (dual use)
	COMPUTER-2 terminal	Mini D sub 15 pin RGB / Y/P _B /P _R (dual use)
	MONITOR terminal	Mini D sub 15 pin RGB / Y/P _B /P _R (dual use)
	S-VIDEO terminal	Mini DIN 4 pin
	AUDIO (L/R) terminal	RCA Pin Jack × 2, 1.5 V (rms), 22 kΩ or more
	VIDEO terminal	RCA Pin Jack, 1 V (p-p), 75 Ω
	AUDIO IN terminal	ø3.5mm dia. stereo mini-jack, 1.5V (rms); 22 kΩ or more
AUDIO OUT terminal	ø3.5mm dia. stereo mini-jack	
	CONTROL terminal	Mini DIN 8 pin (RS-232C)
PC card slot	Compliant with PC Card Standard TYPE II	

* Each plastic part displays the materials it is made from, in order to facilitate recycling after this product becomes no longer usable.

■ Separately sold product

Replacement Lamp Model TLPLW3

■ Note

- Design, specifications, etc. subject to change without notice for improvements, etc.

■ List of supported signals (RGB signals)

This projector supports the following RGB signals. Note, however, that depending on the computer model, the screen may show flicker or streaking. Please adjust the projector if this happens.

(Press the SET UP button, and adjust automatically or manually. [p.26](#), [p.27](#))

Resolution	Mode	Refresh rate (Hz)	H-frequency (kHz)	Clock (MHz)
720 × 400	720x400_85	85.039	37.927	35.500
640 × 480	VGA_60	59.940	31.469	25.175
	VGA_72	72.809	37.861	31.500
	VGA_75	75.000	37.500	31.500
	VGA_85	85.008	43.269	36.000
800 × 600	SVGA_56	56.250	35.156	36.000
	SVGA_60	60.317	37.879	40.000
	SVGA_72	72.188	48.077	50.000
	SVGA_75	75.000	46.875	49.500
	SVGA_85	85.061	53.674	56.250
832 × 624	MAC16"	74.550	49.725	57.283
1024 × 768	XGA_60	60.004	48.363	65.000
	XGA_70	70.069	56.476	75.000
	XGA_75	75.029	60.023	78.750
	XGA_85	84.997	68.667	94.500
	MAC19"	74.700	60.134	79.857
1152 × 864	SXGA1_75	75.000	67.500	108.000
1280 × 960	QuadVGA_60	60.000	60.000	108.000
	QuadVGA_85	85.002	85.938	148.500
1280 × 1024	SXGA3_60	60.020	63.981	108.000
	SXGA3_75	75.025	79.976	135.000
	SXGA3_85	85.024	91.146	157.500
1400 × 1050	SXGA+	60.012	63.973	118.094
1600 × 1200	UXGA_60	60.000	75.000	162.000
	UXGA_65	65.000	81.250	175.500
	UXGA_70	70.000	87.500	189.000
	UXGA_75	75.000	93.750	202.500
	UXGA_85	85.000	106.250	229.500

■ Note

- Signals which resolution exceeds the native resolution (1024 × 768 pixels) will be compressed. For this reason, some information may be lost, or image quality may be affected.

Specifications (Continued)

List of supported signals (Y/P_B/P_R signals)

Signal format	fh(kHz)	fv(Hz)
480i(525i)@60Hz	15.73	59.94
480p(525p)@60Hz	31.47	59.94
576i(625i)@50Hz	15.63	50.00
576p(625p)@50Hz	31.25	50.00
720p(750p)@60Hz	45.00	60.00
720p(750p)@50Hz	37.50	50.00
1080i(1125i)@60Hz	33.75	60.00
1080i(1125i)@50Hz	28.13	50.00
1035i(1125i)@60Hz	33.75	60.00
1152i(1250i)@50Hz	31.25	50.00

List of supported signals (Video, S-Video signals)

Video mode	fh(kHz)	fv(Hz)	fsc(MHz)
NTSC	15.73	60	3.58
PAL	15.63	50	4.43
SECAM	15.63	50	4.25 or 4.41
PAL-M	15.73	60	3.58
PAL-N	15.63	50	3.58
PAL-60	15.73	60	4.43
NTSC4.43	15.73	60	4.43

Pin assignment of COMPUTER-1/2 & MONITOR terminals

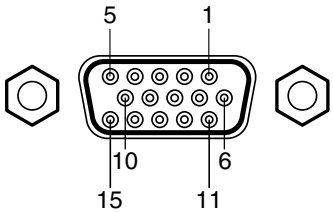

Mini D sub 15 Pin connector

Input Signal

- RGB input
 - RGB signals: 0.7V (p-p) 75 Ω
 - Horizontal sync signal: TTL level (Pos/neg polarity)
 - Vertical sync signal: TTL level (Pos/neg polarity)
- Y/P_B/P_R input
 - Y signal: 1.0V (p-p) 75 Ω
 - P_B/P_R signals: 0.7V (p-p) 75 Ω

Pin No.	Pin description	
	During RGB input	During Y/P _B /P _R input
1	Video signal (R)	Color difference signal (P _R)
2	Video signal (G)	Luminance signal (Y)
3	Video signal (B)	Color difference signal (P _B)
4	GND	*
5	GND	*
6	GND (R)	GND (P _R)
7	GND (G)	GND (Y)
8	GND (B)	GND (P _B)
9	N.C	*
10	GND	*
11	GND	*
12	N.C	*
13	Horizontal sync signal	*
14	Vertical sync signal	*
15	N.C	*

* Do not connect anything.

CONTROL terminal

Pin assignment

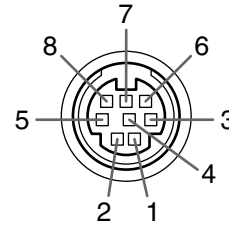

Mini DIN 8 pin connector

Pin No.	Signal Name	Description
1	RXD	Receiving data
2	CTS	Consent to send
3	DSR	Data set ready
4	GND	Signal ground
5	RTS	Request to send
6	N.C	No connection
7	TXD	Sending data
8	GND	Signal ground

Interface format

- 1 Communication method RS-232C, 9600bps, No Parity, Data Length: 8 bits; Stop Bit Length: 1 bit
- 2 Communication format

STX (02h)	Command (3Byte)	ETX (03h)
-----------	-----------------	-----------

Only 1 command valid per communication.
- 3 Data format For input commands, only ASCII-compliant all-uppercase alphanumeric characters supported.
- 4 Replies

Acknowledge	ACK (06h)	CR (0Dh)	Data	... Normally ended
	ACK (06h)	ESC (1Bh)		... Aborted

No acknowledge	NAK (15h)
----------------	-----------

If commands are to be sent consecutively, wait for the response from the projector before sending the next command.

Main Commands

Item	Command
Power on	PON
Power off	POF
Icon display on	MO0
Icon display off	MO1
Auto setting (RGB input)	PAT
Status display on	DON
Status display off	DOF

Item	Command
Computer (1) input select	IN1
Computer (2) input select	IN2
Video input select	IN3
S-video input select	IN4
PC card input select	IN5

Note

- Contact your dealer for control cable and other commands.

TOSHIBA CORPORATION