

**Epson® PowerLite® 830p
Multimedia Projector**

User's Guide

Important Safety Information

WARNING: Never look into the projector lens when the lamp is turned on; the bright light can damage your eyes. Never let children look into the lens when it is on. Never open any cover on the projector, except the lamp and filter covers. Dangerous electrical voltages inside the projector can severely injure you. Except as specifically explained in this *User's Guide*, do not attempt to service this product yourself. Refer all servicing to qualified service personnel.

WARNING: The projector and its accessories come packaged in plastic bags. Keep plastic bags away from small children to avoid any risk of suffocation.

Caution: When you replace the lamp, never touch the new lamp with your bare hands; the invisible residue left by the oil on your hands may shorten the lamp life. Use a cloth or glove to handle the new lamp.

Copyright Notice

All rights reserved. No part of this publication may be reproduced, stored in a retrieval system, or transmitted in any form or by any means, electronic, mechanical, photocopying, recording, or otherwise, without the prior written permission of Seiko Epson Corporation. The information contained herein is designed only for use with this Epson product. Epson is not responsible for any use of this information as applied to other products.

Neither Seiko Epson Corporation nor its affiliates shall be liable to the purchaser of this product or third parties for damages, losses, costs, or expenses incurred by purchaser or third parties as a result of: accident, misuse, or abuse of this product or unauthorized modifications, repairs, or alterations to this product, or (excluding the U.S.) failure to strictly comply with Seiko Epson Corporation's operating and maintenance instructions.

Seiko Epson Corporation shall not be liable for any damages or problems arising from the use of any options or any consumable products other than those designated as Original Epson Products or Epson Approved Products by Seiko Epson Corporation.

Epson is a registered trademark, and EasyManagement, EasyMP, Quick Corner, and Wall Shot are trademarks of Seiko Epson Corporation.

PrivateLine, Presenters Club, and PowerLite are registered trademarks; SizeWise is a trademark; and Epson Connection, Epson Store, and Extra Care are service marks of Epson America, Inc.

Pixelworks, DNX, and the DNX logo are trademarks of Pixelworks, Inc.

General Notice: Other product names used herein are for identification purposes only and may be trademarks of their respective owners. Epson disclaims any and all rights in those marks.

C

Contents

<i>Welcome</i>	9
Using Your Documentation	10
Getting More Information	10
Registration and Warranty	11
Unpacking the Projector	12
Additional Components	12
Optional Accessories	13

1

<i>Displaying and Adjusting the Image</i>	15
Positioning the Projector	16
Projecting the Image	18
Turning On the Projector	18
Selecting the Image Source	20
Troubleshooting Display Problems	21
You Can't Project an Image	21
The Projector and Notebook Don't Display the Same Image	21
Adjusting the Image	24
Adjusting the Height of Your Image	24
Using Quick Setup	25
Focusing and Zooming Your Image	25
Adjusting the Image Shape	26
Correcting Computer Images	28
Shutting Down the Projector	29
Using the Direct Power On Function	30

2

<i>Using the Remote Control</i>	31
Turning On and Using the Remote Control	32
Replacing the Batteries.	33
Controlling the Picture and Sound.....	34
Switching Between Picture Sources	34
Previewing Picture Sources	35
Adjusting the Image Shape.....	36
Turning Off the Picture and Sound.....	37
Stopping Action.....	37
Zooming Part of Your Image.....	38
Displaying a Picture-in-Picture Video	38
Controlling the Volume.....	39
Projecting Images Without a Screen.....	40
Making Initial Color Corrections.....	40
Adjusting Color Corrections for a New Surface	41
Operating Your Computer with the Remote Control.....	41
Highlighting Your Presentation	43
Using the Pointer Tool	43
Customizing the Pointer Tools	44

3

<i>Connecting to Computers and Other Equipment</i>	45
Connecting to a Computer.....	46
Connecting to the Computer Ports	47
Using the Macintosh Desktop Adapter	48
Connecting the Cable for Remote Mouse Control	49
Connecting an External Monitor	50
Connecting to Video Equipment	51
Connecting a Composite Video Source	52
Connecting an S-Video Source	53
Connecting a Component Video Source	54
Connecting an RGB Video Source.....	55
Playing Sound Through the Projector	56
Connecting Audio Equipment to the Projector	56
Connecting External Speakers	57

4	<i>Fine-Tuning the Projector</i>	59
	Using the Menu System	60
	Restoring the Default Settings	61
	Adjusting the Image Quality.....	62
	Adjusting the Image	62
	Adjusting Signal Settings	63
	Adjusting the Image Size, Shape, and Position	65
	Adjusting the Color	66
	Adjusting the Sound.....	67
	Using the Projector Security Features	67
	Enabling Password Protection	68
	Creating Your Own Startup Screen	71
	Disabling the Projector's Buttons.....	72
	Controlling Multiple Projectors	73
	Setting the Projector ID.....	73
	Changing the Remote Control ID	74
	Customizing Projector Features	75
	Remote Monitoring Setup Options	75
	Miscellaneous Setup Options.....	75
	Enabling Quick Setup Options.....	76
	Automatically Running Quick Setup	77

5	<i>Managing Projectors</i>	79
	Connecting and Configuring the Projector on a Wired Network	80
	Using EMP Monitor	81
	Opening and Closing EMP Monitor	82
	Registering Your Projectors	82
	Monitoring Your Projectors.....	85
	Controlling Your Projectors.....	87
	Using EMP NetworkManager	89
	Selecting the Projectors to Monitor	89
	Setting a Password	90
	Creating the E-Mail Settings	90
	Understanding the Notification Messages	93

6 *Maintaining the Projector*..... 95
Cleaning the Lens..... 95
Cleaning the Projector Case..... 96
Cleaning the Air Filters and Vents..... 96
Replacing the Lamp and Air Filters..... 97
 Resetting the Lamp Timer..... 99
Transporting the Projector..... 100

7 *Solving Problems*..... 101
Using On-Screen Help..... 102
Checking Projector Status..... 103
 What To Do When the Lights Flash..... 103
 Viewing Lamp Usage and Other Information..... 105
Solving Problems with the Image or Sound..... 105
Solving EasyManagement Problems..... 111
Solving Problems with the Remote Control..... 111
Where To Get Help..... 112
 Telephone Support Services..... 112

A *Software Installation*..... 113
Windows System Requirements..... 113
Installing the Software on a Windows System..... 114

B *Projector Installation*..... 115

C	<i>Technical Specifications</i>	117
	General	117
	Projection Lamp	118
	Remote Control	118
	Dimensions	118
	Electrical	118
	Environmental	118
	Safety	119
	Compatible Video Formats	119
D	<i>Notices</i>	121
	Important Safety Instructions	121
	Remote Control Information	123
	Declaration of Conformity	124
	FCC Compliance Statement	125
	Warranty	126
	<i>Index</i>	129

W *Welcome*

The Epson® PowerLite® 830p is an easy-to-use, lightweight projector that offers up to 3000 lumens of brightness and a 600:1 contrast ratio for incredibly vivid images and clear text.

Versatility

You can connect it to a wide range of computers and video sources, or you can project over a wired LAN network.

Ease of use

The projector's keystone correction and Quick Corner™ features automatically correct image distortion, and Epson's unique Wall Shot™ function lets you project against blackboards and colored walls without loss of image color, regardless of ambient lighting. The projector also automatically focuses the projected image. These features can all be set to automatically create the best image projection by pressing a single button.

Complete control

Use the remote control to take charge of your presentation. Freeze the action, zoom in on part of the picture, or display a picture-in-picture video. Use the remote as a pointer, or to draw on the screen. You can even use it in place of your computer's mouse to control your computer and change slides in Microsoft® PowerPoint®.

EasyManagement

With the projector's EasyManagement™ system, you can use a Windows® PC to remotely monitor and control the projector over a network.

Security

To prevent unauthorized use, this projector includes several security features including a password, user's logo, and the ability to lock the projector buttons.

Using Your Documentation

This book contains all the information you need to set up and use your projector. Please follow these guidelines as you read through it:

- Warnings must be followed carefully to avoid bodily injury.
- Cautions must be observed to avoid damage to your equipment.
- Notes contain important information about your projector.
- Tips contain additional projection hints.

Getting More Information

Need tips on giving presentations? Quick steps for setting up your projector? Here's where you can look for help:

- **presentersonline.com**
Includes a library of articles covering presentation tips, tricks, and technology. The site provides templates, clip art and sound clips, as well as Presenters Services to use on the road. Even more resources and services are available if you register to join the Presenters Club®—and it's free.
- **Quick Setup sheet**
Gives you the instructions you need to get your projector up and running if you are connecting to a notebook, PowerBook®, or iBook® computer.
- **Start Here kit**
Includes this *User's Guide*, your *Quick Setup* sheet, warranty brochures, and Epson PrivateLine® Support card. Keep the folder with your projector at all times.
- **Built-in help system**
Provides assistance for common problems. Available from the Help button on the projector or the remote control. See page 102 for details.
- **support.epson.com**
Download FAQs and e-mail your questions to Epson support.

- If you still need help after checking this *User's Guide* and the sources listed above, you can use the Epson PrivateLine Support service to get help fast. Call (800) 637-7661 and enter the PIN on the card in your *Start Here* kit. Or take advantage of Epson's automated support services 24 hours a day. See page 112 for more information.

Registration and Warranty

Your projector comes with a basic carry-in warranty as well as an international warranty that let you project with confidence anywhere in the world. For details, see page 126 and the warranty brochure included in your *Start Here* kit.

In addition, for customers who register their projector, Epson offers free Extra CareSM Road Service. In the unlikely event of an equipment failure, you won't have to wait for your unit to be repaired. Instead, Epson will ship you a replacement unit anywhere in the United States or Canada, usually via overnight delivery. See the brochure in your *Start Here* kit for details.

To register, simply fill out the registration card included in your *Start Here* kit and mail it to Epson. Or you can register online at <http://www.epson.com/webreg>. Registering also lets you receive special updates on new accessories, products, and service.

Unpacking the Projector

After unpacking the projector, make sure you have all the parts shown below:

note

You won't need all these components; your configuration will determine which ones you need.

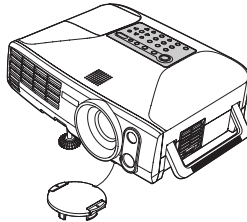

Projector



Remote control and batteries

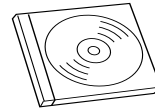

Projector software CD-ROM



Power cable

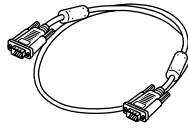

VGA computer cable

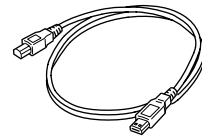

USB cable

Save all packaging in case you need to ship the projector. Always use the original packaging (or the equivalent) when you need to send the projector to another location. If you are moving the projector by hand, use a carrying case. See page 13 for ordering information, and page 100 for transportation instructions.

Additional Components

Depending on how you plan to use the projector, you may need additional components:

- To receive an S-Video signal, you'll need an S-Video cable. One may be provided with your video equipment, or you can purchase one from Epson; see page 13.
- To receive a component video signal from a VCR or other video device, you'll need a component video cable. You can purchase one from Epson; see page 13.

- Some older PowerBooks® and Macintosh® desktop models may need the Macintosh desktop adapter set shown on page 48 (available from Epson; see page 13.) Older iMac® systems may need a special adapter to provide a VGA output port; see your computer dealer.

Optional Accessories

To enhance your use of the projector, Epson provides the following optional accessories:

Product	Part number
Replacement lamp	V13H010L31
Air filter replacement set	V13H134A07
ATA molded hardshell case Samsonite® wheeled soft case	ELPKS35 ELPKS52
Ceiling mount Suspension adapter False ceiling plate Security bracket/cabbling for gyro lock mounts Adjustable ceiling channel	ELPMB36 ELPMBAPL ELPMBFCP ELPMBSEC ELPMBACC
Kensington® security lock	ELPSL01
Projection screens: 50-inch portable screen 60-inch portable pop-up screen 80-inch portable pop-up screen 83.6-inch hanging pull-down screen	ELPSC06 ELPSC07 ELPSC08 ELPSC09
Macintosh adapter set	ELPAP01
Component video cable S-Video cable	ELPKC19 ELPSV01
Distribution amplifier	ELPDA01
Image Presentation Camera High resolution document camera	V12H162020 V12H064020

You can purchase these accessories from your dealer, by calling Epson at (800) 873-7766, or by visiting the Epson StoreSM at www.epsonstore.com (U.S. sales only). In Canada, please call (800) 463-7766 for dealer referral.

1 *Displaying and Adjusting the Image*

Whether you're presenting from a computer or video equipment, you need to follow some basic steps to display your image on the screen.

Follow the guidelines in this chapter for:

- Positioning the projector
- Turning the projector on and selecting the image source
- Troubleshooting display problems
- Adjusting the image
- Turning off the projector

note

You can mount the projector on the ceiling, or place it behind a translucent screen for rear projection. See page 115 for details.

Positioning the Projector

If the projector isn't already installed in the room you're using, you'll probably want to place it on a table in front of the screen, as shown. This lets you stand in the front of the room, face the audience, and remain close enough to the equipment to be able to control it. Try to leave as much space as possible between the projector and the screen to get a good-size image.

Use the figure below to help you determine placement. Image size increases with distance, but can vary depending on how you position the zoom ring and whether you've adjusted the image with other settings.

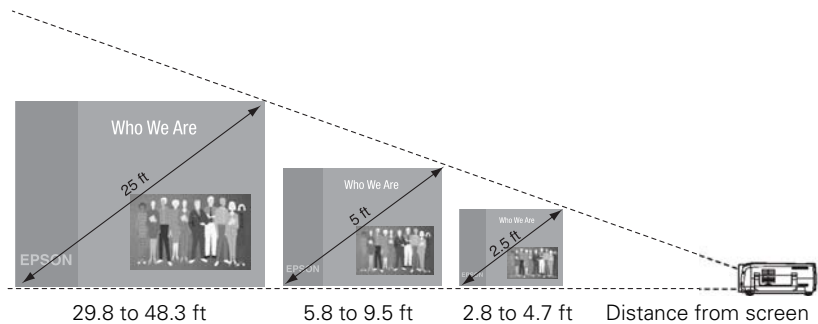

Also keep these considerations in mind:

- Place the projector on a sturdy, level surface.
- Make sure there is plenty of space for ventilation around and under the projector. Do not set the projector on top of anything that could block the vents under the projector.
- Make sure the projector is within 10 feet of a grounded electrical outlet or extension cord.

Ideally, you should place the projector directly in front of the center of the screen, facing it toward the screen squarely. The base of the lens should be at about the level of the bottom of the screen.

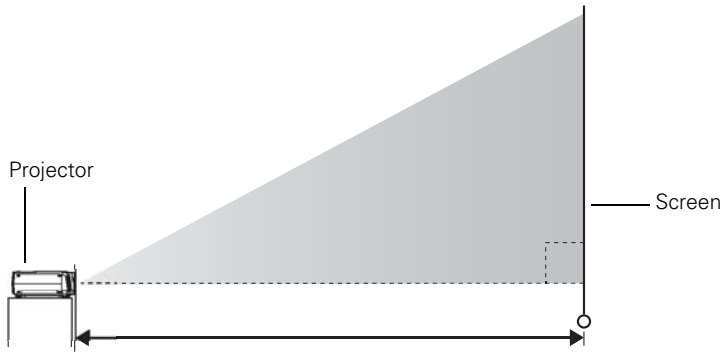

If you place the projector below screen level, you'll have to tilt it up by extending the front adjustable foot. This causes the image to become "keystone" shaped, but you can correct the distortion by pressing the **Sync** buttons on the projector. See page 26 for detailed information about correcting the image shape.

For instructions on installing the projector in a permanent location, such as a theater or conference room, see page 115.

note

After positioning the projector, you may want to connect a Kensington MicroSaver® anti-theft device to the lock port on the projector's left side. You can purchase this from Epson; see "Optional Accessories" on page 13.

Projecting the Image

Make sure your projector and other equipment are set up as described on page 45. Then follow the instructions below to start the projector and display an image.

Turning On the Projector

note

To shut down the projector, see page 29. Shutting down the projector correctly prevents premature lamp failure and possible damage from overheating.

Turn on any connected computer or video equipment before starting the projector so it can automatically detect and display the image source. If you turn on the projector first, or have multiple pieces of connected equipment, you may have to select the image source manually (see page 20).

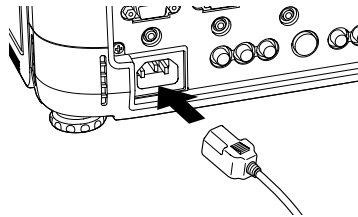

Follow these steps to turn on the projector:

1. Remove the lens cap.
2. Plug one end of the power cable into the projector, and the other end into a grounded electrical outlet.

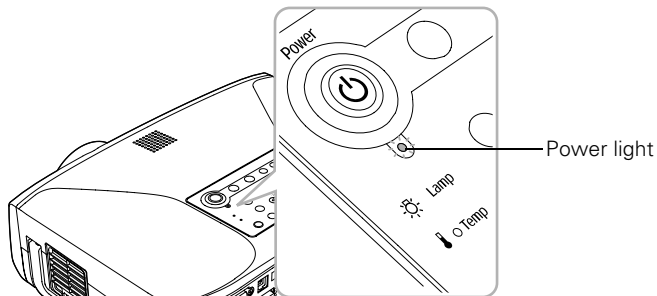

3. Wait until the Power light stops flashing and turns orange.



4. Press the red  Power button on top of the projector—or press the  Power button on the remote control.

(If this is your first time using the remote control, make sure the batteries are installed and the ON/OFF switch on the side of the remote is turned on.)

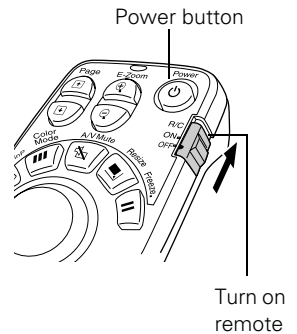
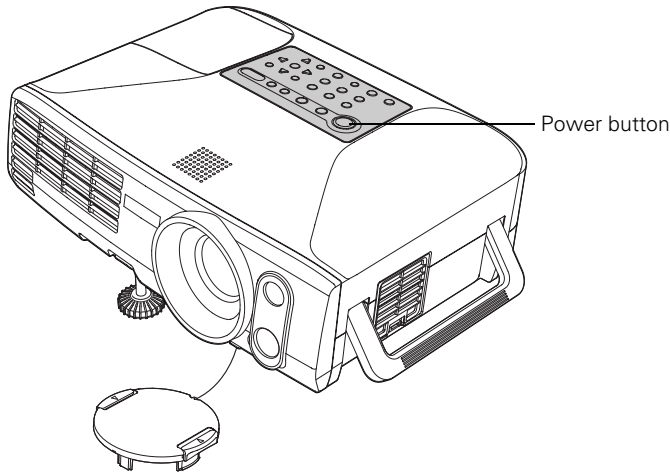

The projector beeps once and the **Power** light flashes green as the projector warms up, then an image begins to appear. When the **Power** light stops flashing and remains green, the projector is ready for use.

5. If you've connected a Windows-based computer to the projector, you may see a New Hardware Wizard screen saying your computer has found a plug-and-play monitor; if so, click **Cancel**.
6. If you are prompted to enter a password, see page 68.

warning

Never look into the lens when the lamp is on. This can damage your eyes, and is especially dangerous for children.

note

To focus and adjust the image, see page 24. If a projected image fails to appear, see page 21 for help.

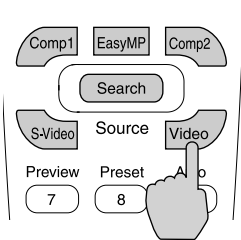
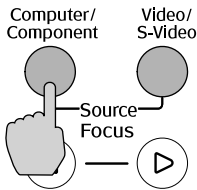

note

You can also preview all sources on one screen to help you select the desired source (see page 35).

Selecting the Image Source

Selecting the image source lets you switch between images input from different pieces of connected equipment (such as a computer or DVD player).

If you don't see the image you want, press the **Source Search** button on the remote control or the projector.

You can also select your image using the **Source** buttons either on the projector or the remote control as follows:

- The projector has two **Source** buttons. Use the **Computer/Component** button to switch between equipment connected to the **Computer/Component** ports.

Use the **Video/S-Video** button to switch between equipment connected to the **Video** and **S-Video** ports.

- The remote control has four source buttons. Use them to switch between devices connected to the ports identified on each button. The PowerLite 830p does not support EasyMP.™

You can also press the **Source Search** button on the projector or the remote repeatedly until you see the image you want to project on the screen.

Troubleshooting Display Problems

Follow these guidelines if you're having trouble displaying an image.

You Can't Project an Image

If you don't see the image you are trying to project, try the following:

- Make sure the cables are connected correctly, as described beginning on page 45.
- Make sure the **Power** light is green and not flashing and the lens cap is off.
- If you've connected more than one computer and/or video source, you may need to press one of the **Source** buttons on the projector's control panel or the remote control to select the correct source. (Allow a few seconds for the projector to sync up after pressing the button.)
- If you're using a PC notebook, press the function key on your keyboard that lets you display on an external monitor. It may be labeled **CRT/LCD** or have an icon such as . You may have to hold down the **Fn** key while pressing it. Allow a few seconds for the projector to sync up after changing the setting.

The Projector and Notebook Don't Display the Same Image

If you're projecting from a notebook, and you can't see your image on the projection screen and on your computer at the same time, follow these guidelines.

If you're using a PC notebook:

- On most systems, there's a function key that lets you toggle between the LCD screen and the projector, or display on both at the same time. It may be labeled **CRT/LCD** or have an icon such as . You may have to hold down the **Fn** key while pressing it. Allow a few seconds for the projector to sync up after changing the setting.

- If the function key doesn't permit you to display simultaneously on both screens, you should check your monitor settings to make sure both the LCD screen and the external monitor port are enabled.

From the Control Panel, open the **Display** utility. In the Display Properties dialog box, click the **Settings** tab, then click **Advanced**. The method for adjusting the settings varies by brand; you may need to click a **Monitor** tab, then make sure the external Monitor port is set as your primary display and/or enabled. See your computer's documentation or online help for details.

If you're using Macintosh OS X:

You may need to set up your system to display on the projector screen as well as the LCD screen. Follow these steps:

1. From the Apple menu, select **System Preferences**, then select **Displays**.
2. Make sure the **VGA Display** or **Color LCD** dialog box is selected.
3. Click the **Arrangement** (or **Arrange**) tab.

Make sure
Mirror Displays
is checked



4. Make sure the **Mirror Displays** checkbox is selected.

If you're using OS 8.6 to OS 9.x:

You may need to set up your system to display on the projector screen as well as the LCD screen. Follow these steps:

1. From the Apple menu, select **Control Panels**, then click **Monitors** or **Monitors and Sound**.
2. Click the **Arrange** icon.

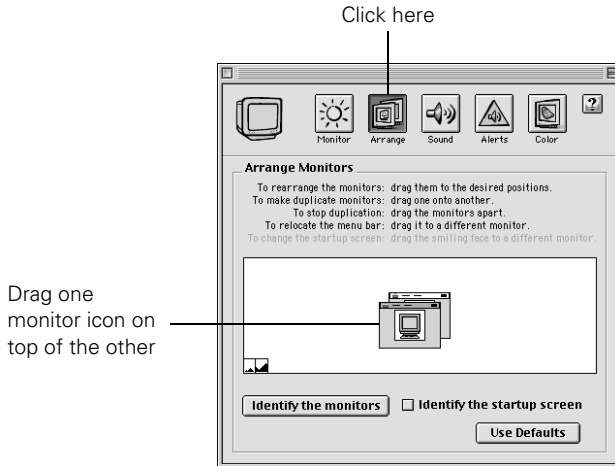

3. Drag one monitor icon on top of the other.

If the **Arrange** option isn't available, you may need to select one of the **Simulscan** resolution settings:

1. Click the **Monitor** icon.

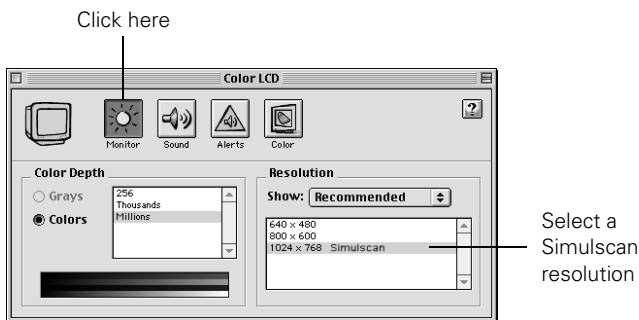

2. Select a **Simulscan** resolution as shown. (Allow a few seconds for the projector to sync up after making the selection.)

Adjusting the Image

Once you see your image, you need to make certain adjustments:

- If the image is too high or too low, you can reposition it. See below.
- If you have quick setup enabled on the projector, see page 25.
- To focus or zoom your image, see page 25.
- If the image isn't square, see page 26.
- If a computer image displays incorrectly, see page 28.

If you need to fine-tune the image and/or sound, see Chapter 4.

Adjusting the Height of Your Image

If the image is too low on the screen, you can use the front adjustable foot to raise it.

1. Stand behind the projector. Press the blue foot release lever up and lift the front of the projector.

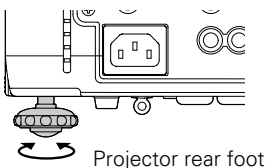
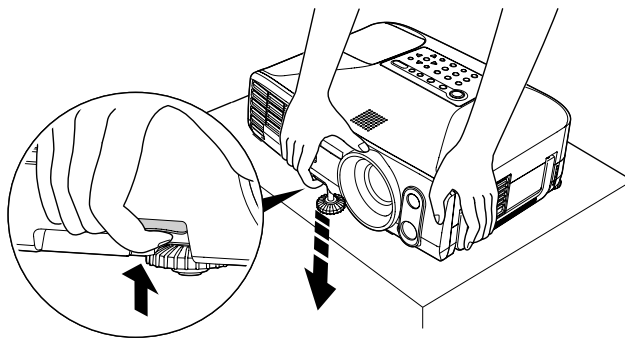

2. Once the image is positioned where you want it, release the lever to lock the foot in position.
3. If necessary, you can fine-tune the height or level the image by turning the projector's rear feet.

Raising the projector causes the image to distort or “keystone,” but you can manually correct the shape as described in the next section.

Using Quick Setup

You can use the **Quick Setup** button on the projector or the remote control to quickly and automatically set up the projector's focus, zoom, and shape, as well as the Wall Shot setting. All you need to do is position your projector, then press **Quick Setup**. Make sure you enable Quick Setup for all of the settings you want to use as described on page 76.

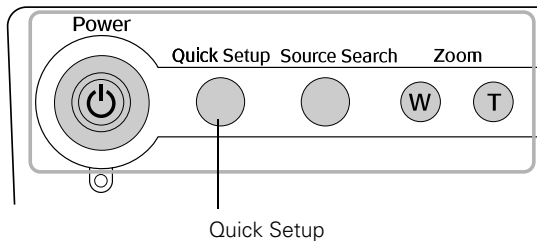

Focusing and Zooming Your Image

Use the **Focus** buttons on the projector or remote to sharpen the image.

Use the **Zoom** buttons on the projector or remote to reduce or enlarge the image. Press the **W** button on the projector or the top zoom button on the remote to increase the size, and the **T** button on the projector or bottom zoom button on the remote to decrease it.

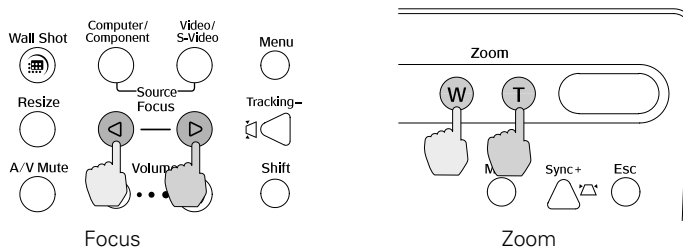

If the image still isn't large enough, you may need to move the projector farther away from the screen. You can also use the **E-Zoom** buttons on the remote control to zoom in on a portion of the image. See page 38 for instructions.

Adjusting the Image Shape

In most cases, you can maintain a square or rectangular image by placing the projector directly in front of the center of the screen with the base of the lens level with the bottom of the screen.

Even if the projector is slightly tilted (within a range of 40° up or down), the projector has an automatic keystone correction function that detects and corrects vertical keystone distortion.

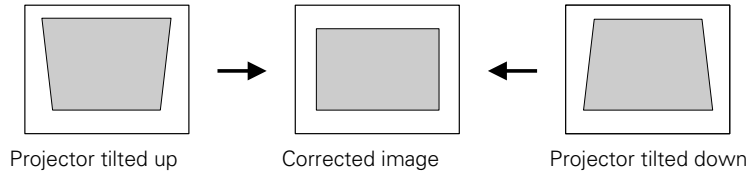

It takes about one second after projection starts for the image to be corrected. During this time, a vertical keystone correction gauge appears on the screen.

If your image is still distorted, you can correct it using either of these methods:

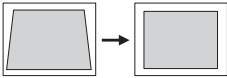

Keystone correction

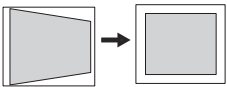

Keystone correction

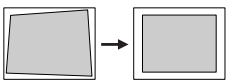

Quick Corner correction

- If the image has two parallel sides but is wider on one side (top, bottom, left, or right), you can correct it using the Keystone buttons on the projector's control panel (see page 27) or the projector's Keystone menu (see page 27).
- If the image has no parallel sides, you can adjust its shape using Quick Corner (see page 36).

You cannot use both keystone correction and Quick Corner at the same time.

Using Keystone Correction

To adjust your image when it is wider on one side, do the following:

- Look at the shapes of the icons on the projector's four keystone buttons. Press the button whose icon is the opposite of the shape of your screen image. Continue pressing the button until you are satisfied with the shape of the image.



- Or press the Menu button on the remote control, select the Setting menu, and press Enter. From the Setting menu, select Keystone and press Enter, select H/V Keystone and press Enter, then select Horiz./Vert./Height and press Enter. Select V-Keystone (for vertical keystone distortion) or H-Keystone (for horizontal keystone distortion) and press Enter. Use the  pointer button on the remote control to adjust the keystone setting as needed.

note

The image will be slightly smaller after adjusting. If it's important to maintain the correct aspect ratio, use the menu system to perform keystone correction, then use the remote's Resize button to adjust the aspect ratio. See page 65.

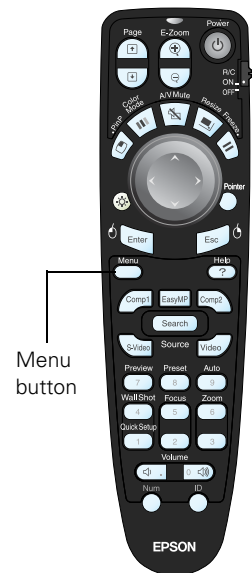

Correcting Computer Images

note

You must be projecting an image for this button to have any effect. The Auto button works only with computer images.

If you're connected to a computer and the image doesn't look right, press the **Auto** button on the remote control. This automatically resets the projector's tracking, sync, resolution, and position settings.

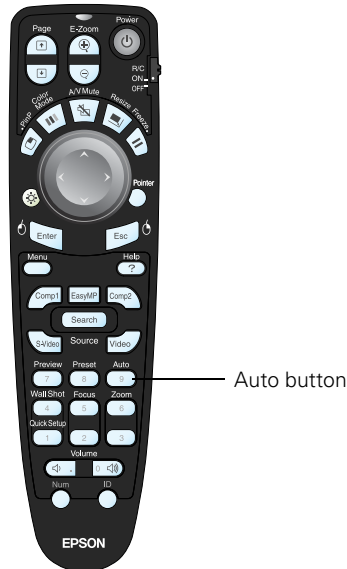

If vertical bands appear in the projected image and the **Auto** button doesn't correct the problem, hold down the **Shift** button on the projector's control panel while pressing either the **Tracking +** or the **Tracking -** button.

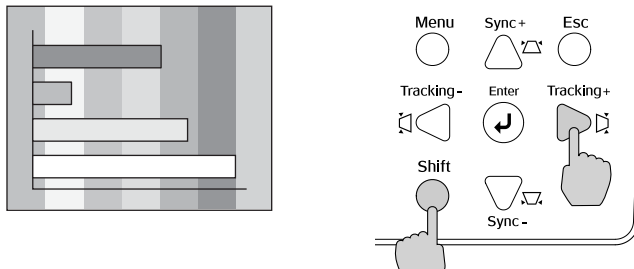

If the image appears fuzzy or flickers and the **Auto** button doesn't correct the problem, hold down the **Shift** button while pressing either the **Sync +** or **Sync -** button on the projector.

Shutting Down the Projector

When you've finished using the projector, follow the recommended procedure to shut it down. This extends the life of the lamp and protects the projector from possible overheating.

1. Turn off any equipment plugged into the projector.
2. To turn off the projector, press the red  Power button on the projector or remote control.

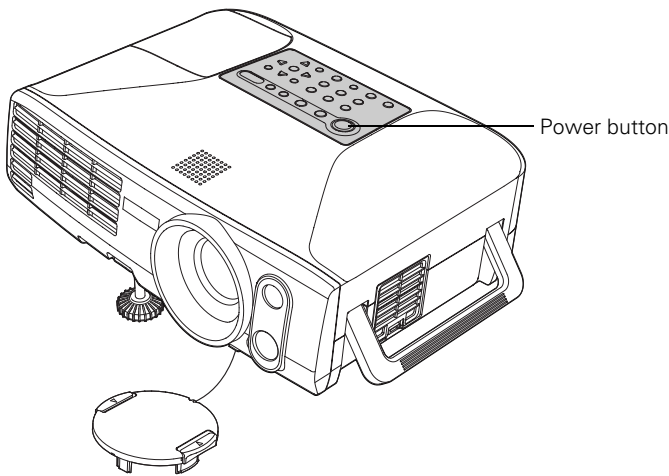

You see a confirmation message. (If you don't want to turn it off, press any other button.)

3. Press the  Power button again. The projector beeps twice, the lamp is turned off, and the Power light flashes orange for about 30 seconds as the projector cools down. After the projector has cooled, the orange light stays on and the exhaust fan shuts off.

If you want to turn the projector on again, wait until the orange light stops flashing. Then press the  Power button.

4. If you extended the adjustable front foot, press up on the blue foot release lever to retract it.
5. Replace the lens cap and unplug the power cord.
6. If you're using a remote control, set its ON/OFF switch to OFF.

note

You can set the projector to automatically turn off the projector lamp and enter "sleep mode" when it has not received any signals for 30 minutes. This conserves electricity, cools the projector, and extends the life of the lamp. If you want to start projecting again, press the  Power button. If you are done using the projector, unplug the power cord. To turn off sleep (standby) mode, see page 75.

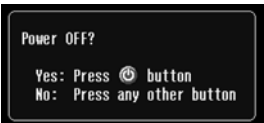

caution

Turn the projector off when not in use. Continuous 24-hour-a-day use may reduce the projector's overall life.

Using the Direct Power On Function

The Direct Power On function enables fast and easy setup and shut down. This feature is convenient for ceiling mounted projectors because you can simply flip a switch that is connected to the power outlet for the projector to turn it on or off. For desktop or table-top use, you can quickly unplug the projector immediately without having to wait for it to cool down. Then you can pack up the projector and go.

Follow these steps to enable Direct Power On:

1. Press the **Menu** button on the remote control and select the **Extended** menu.
2. Choose **Operation** and press **Enter**.
3. Choose **Direct Power On** and press **Enter**.

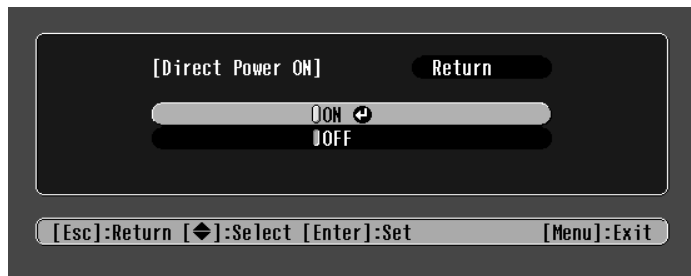

4. Highlight **On** and press **Enter**.
5. Press **Esc** or **Menu** to exit.

2

Using the Remote Control

The projector includes a number of tools to enhance your presentation. All of them can be accessed using the remote control, which lets you operate the projector from anywhere in the room—up to 33 feet away.

note

For information and resources to help you give the most professional presentation, be sure to visit presentersonline.com.

You can use the remote control to adjust the picture and sound (page 34) or as a pointer to highlight your presentation (page 43). You can also use it to make automatic color corrections that let you project images onto any surface (page 40) or as a wireless mouse when projecting from a computer (page 41).

This chapter covers:

- Turning on and using the remote control
- Controlling the picture and sound
- Projecting images without a screen
- Operating your computer with the remote control
- Highlighting your presentation

Turning On and Using the Remote Control

The remote control has an ON/OFF switch on its side, as shown. Before using the remote, make sure batteries are installed as described on page 33, then push up on the ON/OFF switch to turn it on.

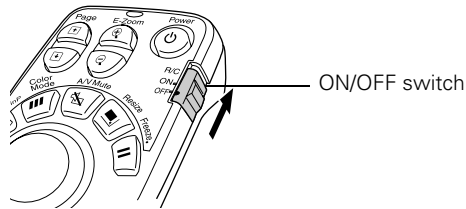

note

If a button is pressed longer than 60 seconds, the remote control stops operating to conserve power. When you release the button, normal operation resumes.

Turn off the remote control before transporting or storing it; this prevents the batteries from discharging if something presses against one of the buttons.

Here are some additional tips:

- Point the remote control either at the front or back of the projector, or at the screen.
- Stand within 33 feet of the projector. If you want to operate the projector from a greater distance, a remote control cable set is available (see page 13).
- When presenting in a darkened room, press the  light button to make the buttons on the remote light up temporarily.
- Avoid using the remote under bright fluorescent lamps or in direct sunlight, or the projector may not respond properly.

Replacing the Batteries

If the projector stops responding to the remote control, check the following:

- Make sure the remote control's ON/OFF switch (shown on page 32) is in the ON position.
- Press the ☼ light button and check to see if the buttons on the remote control light up. (If you're in a bright room, you may not be able to see them light up.)

If the buttons do not light up, replace the batteries as described below:

1. Turn the remote control over.
2. Press down on the ridges at one end of the battery cover as you slide the cover off.
3. Install two AA batteries, inserting the flat (negative) ends in first.
4. Slide the cover back in place.

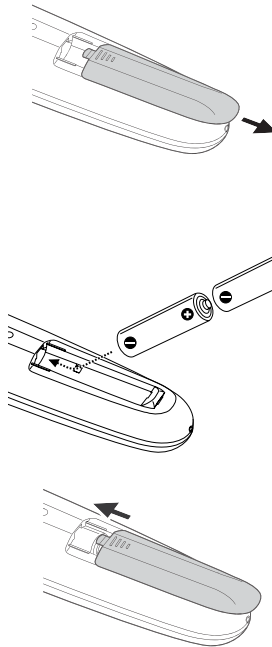

caution

When replacing batteries, take the following precautions:

- *Replace the batteries as soon as they run out. If the batteries leak, wipe away battery fluid with a soft cloth. If fluid gets on your hands, wash immediately.*
- *Do not expose batteries to heat or flame.*
- *Dispose of used batteries according to local regulations.*
- *Remove the batteries if you won't be using the projector for a long period of time.*

Controlling the Picture and Sound

note

You can use the projector's menus to fine-tune the picture and sound quality as described on page 59.

You can use the remote control to preview and select your picture sources, temporarily turn off the picture and sound, freeze the action, zoom in on the picture, display a picture-in-picture image, and adjust the volume.

Switching Between Picture Sources

If your projector is connected to more than one computer and/or video source, you can switch between the different sources:

- The easiest way to select your source is to press the **Source Search** button on the remote control or projector repeatedly until you see the image you want on the screen.
- On the projector's control panel, there are three **Source** buttons: Press the **Source Search** button to automatically search for any image signals from connected devices, press the **Computer/Component** button to switch between equipment connected to the **Computer/Component** ports, or press the **Video/S-Video** button to switch between equipment connected to the **Video** and **S-Video** ports.
- On the remote control, there are four **Source** buttons. Use them to switch between equipment connected to the port identified on each button.

After you select a source, the screen goes dark for a moment before the image appears.



Source buttons

Previewing Picture Sources

You can display a preview image from each connected source to help you select the image source you want.

1. Press **Preview** on the remote control.

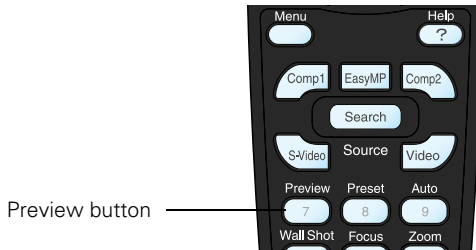

You see the currently selected source displayed in the main window, as shown below. All other sources (including the currently selected source) are displayed in smaller preview windows on the right side and at the bottom. If no equipment is connected to a port, there is no incoming signal, or the signal is out of range, the preview window for that source appears blank.

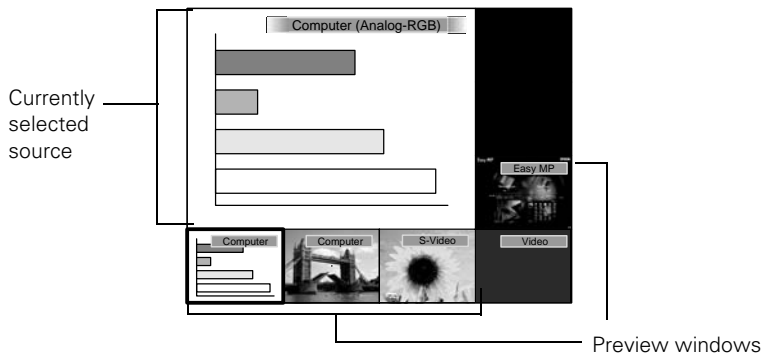

2. Press one of the **Source** buttons on the remote control to switch to the desired source. Press **Enter** to change the source and exit the screen or press **Esc** to exit the preview screen without switching sources.

note

Movies are displayed as still images on the preview screen.

note

*A red highlight surrounds the preview window for the currently selected source. Use the  pointer button on the remote control to highlight a different source and press **Enter** to display it.*

Adjusting the Image Shape

Even if your projected image has no parallel sides, you can even up the sides using Quick Corner. Follow these steps:

1. Press the **Menu** button on the remote control (or on the projector's control panel).
2. Select the **Setting** menu and press **Enter**.
3. From the Setting menu, select **Keystone** and press **Enter**.
4. Select **Quick Corner** and press **Enter**.

You see this screen:

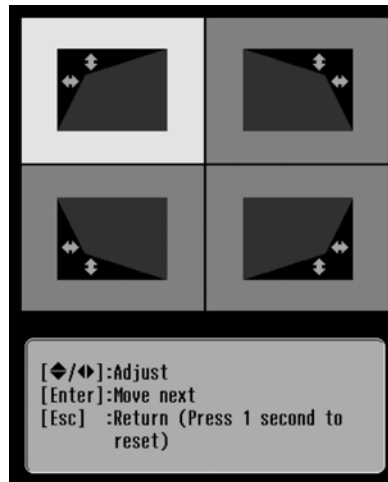

note

*If you are already using Keystone settings, you see a warning message. To disable keystone settings and use Quick Corner instead, press **Enter**; to keep your settings, press **Esc**.*

note

*If you are not satisfied with the corrections made, press the **Esc** button for one second to reset the screen to its original shape.*

5. Press the **Enter** button to select the corner you want to adjust.
6. Use the  pointer button on the remote control (or the arrow buttons on the projector) to adjust the shape.
7. Repeat steps 5 and 6 as needed to adjust any remaining corners.
8. When done, press the **Esc** button on the remote control or projector's control panel to exit the menu system.

If **Quick Corner** remains selected in the Keystone menu, the Quick Corner screen appears whenever you press the projector's keystone buttons. You can then follow steps 5 through 8 above to correct the shape of your image or press **Esc** to exit Quick Corner.

Turning Off the Picture and Sound

You can use the A/V Mute button on the remote control to turn off the image and sound and darken your screen. This feature is useful if you want to temporarily redirect your audience's attention without the distraction of a bright screen.

- To turn off the picture, press the A/V Mute button. The screen goes dark.
- To turn the image back on, press the button again.

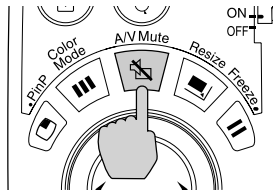

You can also have an image, such as a company logo, display on the screen whenever you press the A/V Mute button (see page 71).

Stopping Action

You can use the remote control to stop the action in your video or computer image.

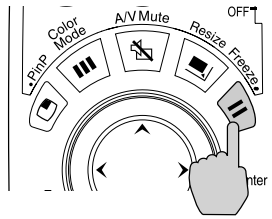

- To stop the action and keep the current image on the screen, press the Freeze button. The sound continues.
- To restart it, press the Freeze button again.

note

If you've connected a computer to one of the projector's Computer ports and an external monitor to the projector's Monitor Out port, the monitor will continue displaying.

note

This function pauses the image, but not the sound. Also, because the source continues to transmit signals, you won't resume the action from the point you stopped it.

Zooming Part of Your Image

You can zoom in on a portion of the image using the E-Zoom buttons on the remote control.

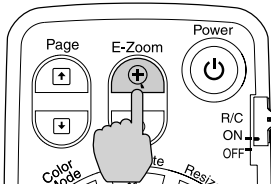

1. Press the E-Zoom **+** button on the remote control.
You see a crosshair indicating the center of the zoom-in area.
2. Use the **⦿** pointer button to position the crosshair.
3. Continue pressing the E-Zoom **+** button to enlarge the selected area up to 4 times.
4. While the image is enlarged, you can:
 - Use the **⦿** pointer button to move around the screen.
 - Press the E-Zoom **-** button to zoom out.
5. When done, press the ESC button to return the image to its original size.

Displaying a Picture-in-Picture Video

If you're displaying an image from equipment connected to the Computer port(s), you can open up a smaller picture-in-picture window on the screen. This window can display video from equipment connected to either the Video or S-Video port.

Setting Up the Picture-in-Picture Image

Before starting, make sure the computer or video equipment for your main image is connected to the Computer port(s), and the video equipment for the picture-in-picture window is connected to the Video or S-Video port. Then select the corresponding video setting:

1. Press the Menu button on the remote control and enter the Setting menu.
2. Highlight P in P Options and press Enter, then use the pointer button to select Subscreen Image and press Enter. Use the pointer to choose Video or S-Video, then press Enter.
3. Press Menu to exit the menu system.

note

The Picture-in-Picture function does not work for RGB video images.

Displaying the Picture-in-Picture Image

Make sure your main image source is displayed, then follow these steps to display and use the picture-in-picture window:

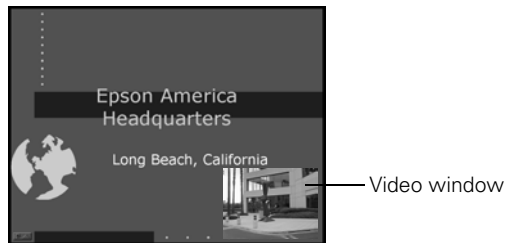

1. Press the PinP button on the remote control.
2. Use the  pointer button to reposition the video window.
3. Once the window is the way you want it, press the Enter button; your video continues playing on the screen.

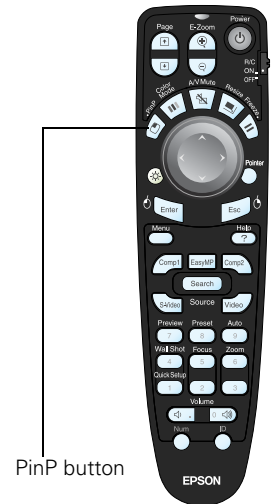

4. When you're finished using picture-in-picture, press the PinP or  pointer button again. The window disappears.



Controlling the Volume

To change the volume, press the  (quieter) or  (louder) side of the Volume button.

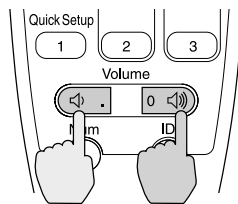

If necessary, you can adjust the tone using the projector's menu system. See page 67.

note

You can also use the Volume buttons on the projector to adjust the volume.

To temporarily shut off the sound and picture, press the A/V Mute button.

Projecting Images Without a Screen

Even if you don't have a screen, you can project images onto surfaces like blackboards and colored walls without loss of image color. Your projector has a sensor that measures the conditions of the projection surface and automatically adjusts the colors and shading of your image. For example, if you're projecting onto a surface near a window, your image appears clear and bright rather than faint.

note

If the status message indicates that Wall Shot is off, press the Wall Shot button again to turn it on.

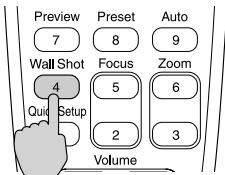

Making Initial Color Corrections

Press the Wall Shot button on either the remote control or the projector's control panel while projecting an image.

Wall Shot's status appears in the upper right corner of your screen. Then you see a sequence of colors flash for a couple of seconds while the sensor measures the conditions of the projection surface and adjusts the image.



The projector stores the correction values obtained by the last Wall Shot measurements. This is useful if you're projecting against the same surface and under the same conditions. To retrieve these corrections, repeatedly press the Wall Shot button until you see Wall Shot Memory Call. This setting applies the stored Wall Shot values.

Adjusting Color Corrections for a New Surface

Adjust the correction values if you're projecting on a new surface or in a new location.

1. Press the **Wall Shot** button on the remote control or projector while you're projecting an image. Make sure Wall Shot is on.
2. Press the **Wall Shot** button a couple of times until you see **Wall Shot Readjustment** as the status in the upper right corner of your screen.



You see a sequence of colors flash for about five seconds as the projector adjusts the color correction values for the new projection surface.

Operating Your Computer with the Remote Control

If you've connected a computer to the projector with a USB cable, as described on page 49, you can use the remote control in place of your computer's mouse. This gives you more flexibility when delivering slideshow-style presentations, since you won't have to stand next to the computer to change slides.

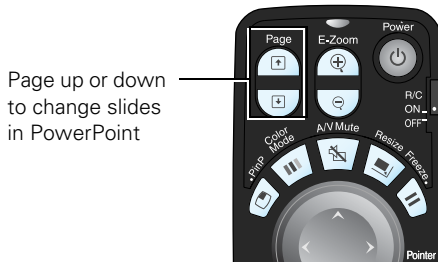
- Use the **Page** buttons to move through a slideshow.



- Use the  pointer button to move the cursor on the screen.
- Press the **Enter** button once to left-click, or press it twice to double-click. Press the **Esc** button to right-click.
- To drag-and-drop, hold down the **Enter** button for about one second until it lights. Then use the  pointer button to drag the object. When it's where you want it, press **Enter** to release it.



Highlighting Your Presentation

You can display a pointer to call out something on the screen, or draw straight or curved lines to emphasize particular points. There are three pointer tools you can choose from and each one can be customized for a different look.

Using the Pointer Tool

1. To activate the pointer tool, press the **Pointer** button on the remote control. A pointer appears on the screen.

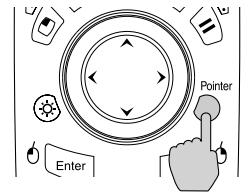
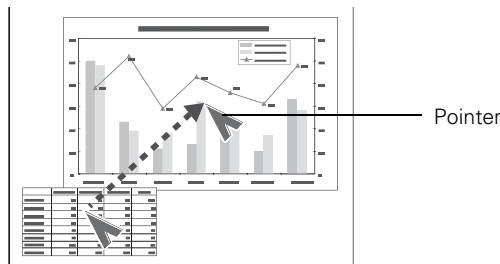

If you prefer to use a different style of pointer, see page 44 to choose from three preset options.

2. Use the  pointer button on the remote control to position the pointer on the screen.
3. When done using the pointer, press **Esc** to clear the screen.

Customizing the Pointer Tools

You can customize the shape and size of each of the three pointer tools, and set how fast you can move the pointer across the screen.

1. Press the **Menu** button on the remote control, highlight the **Setting** menu, highlight **Pointer**, and press **Enter**.

You can select one of the following pointer shapes:



2. Highlight **Return** and press **Enter**.
3. To change the size of the pointer, highlight **Pointer Zoom** and press **Enter**.
4. Choose **100%** or **200%** and press **Enter**.
5. Highlight **Return** and press **Enter**.
6. To change the **Pointer Speed** setting, highlight **Pointer Speed** and press **Enter**.
7. Highlight **High Speed**, **Medium Speed**, or **Low Speed** and press **Enter**.
8. Highlight **Return** and press **Enter**.
9. Press **Menu** to exit from the menu system.

3

Connecting to Computers and Other Equipment

This chapter tells you how to connect the projector to a notebook or desktop computer, and/or to video equipment, such as a VCR or DVD player. You can also connect the projector to a video camera, external speakers, and/or an external monitor.

Follow the instructions in this chapter on:

- Connecting to a computer
- Connecting an external monitor
- Connecting video equipment
- Playing sound through the projector

Connecting to a Computer

note

*If you connect a Windows-based computer to the projector, you may see a New Hardware Wizard saying your computer has found a plug-and-play monitor; if so, click **Cancel**.*

note

For newer PowerBooks with DVI connectors, see your computer's documentation to see how to use a DVI to VGA adapter (usually included with the computer) to connect to the VGA Computer port.

If you're using an older Macintosh and you can't connect the cable to your computer, you may need to use the Macintosh desktop adapter, as shown on page 48 (available from Epson; see page 13).

You can connect the PowerLite projector to any computer that has a standard video output (monitor) port, including desktop models, PC notebook and notebook computers, Macintosh PowerBooks and iBooks®, and hand-held devices. You can connect up to two computers at the same time. To connect to the **Computer/Component** ports (standard VGA cable connection), see page 47. After connecting to the computer, you may also want to:

- connect a USB cable so you can use the remote control as a mouse; see page 49
- connect a monitor to the projector so you can view your presentation close-up as well as on-screen (not necessary if you're using a notebook); see page 50
- connect an audio cable to play computer audio; see page 56

Connecting to the Computer Ports

You can connect to either Computer/Component port using the VGA computer cable that came with the projector (the monitor port on your computer must be a mini D-sub 15-pin port).

1. If you're using the VGA computer cable, connect one end to one of the projector's Computer/Component ports, and the other end to your computer's monitor port. Then go to step 4.

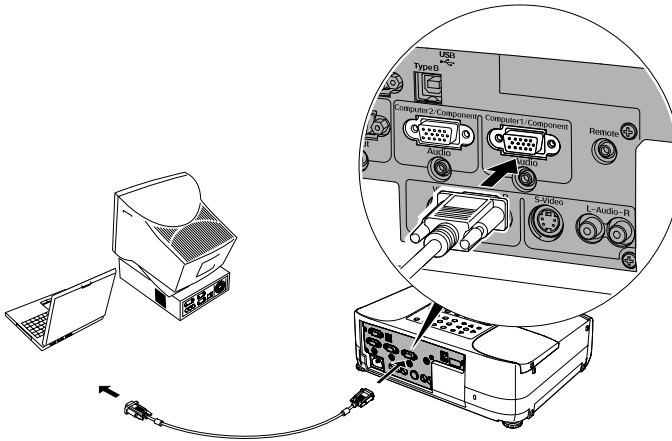

2. You can connect an optional stereo mini-jack audio cable to play sound through the projector (see page 56), an external monitor (see page 50), or a USB cable to use the remote control as a mouse (see page 49).
3. When you've finished making any connections, see page 18 for instructions on turning on the projector and adjusting the image.

caution

Don't try to force a connector to fit a port with a different shape or number of pins. You may damage the port or connector.

Using the Macintosh Desktop Adapter

If you have an older desktop Macintosh or PowerBook, the VGA cable may not fit when you try to connect it. If so, you'll need to use the Macintosh desktop adapter to connect the VGA cable to your computer. This is available from Epson (see page 13).

1. To use the adapter, remove its cover as shown and set its DIP switches according to the resolution you want to use, such as 16-inch mode. See your Macintosh documentation for instructions.

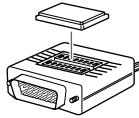

2. Replace the cover and connect the adapter to the VGA cable. Then plug the cable (with the adapter) into the video port on your Macintosh.
3. Tighten the screws on the connectors.

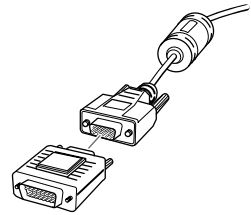

Connecting the Cable for Remote Mouse Control

If you've connected a computer as described in this chapter, you can use the projector's remote control as a wireless mouse. This lets you control your computer and click through slideshow-style presentations, such as PowerPoint, from up to 33 feet away.

The wireless mouse function is supported on systems with a USB port running Windows XP, 98, Me, or 2000, or Macintosh OS X 10.2.x to 10.3.x or OS 8.6 to OS 9.x.

1. Locate the USB cable that came with your projector.
2. Connect the square end of the cable to the projector's  USB port.

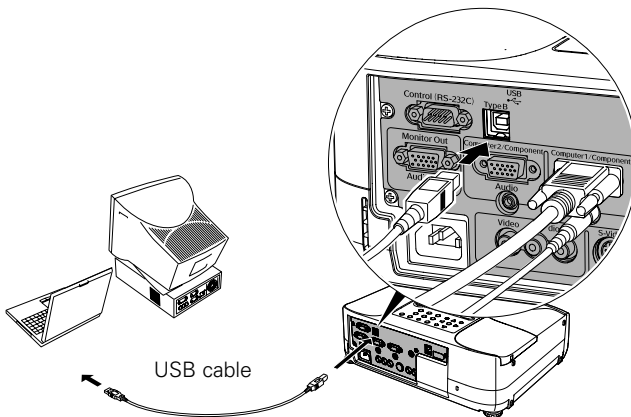

3. Connect the flat end of the cable to any available USB port on your notebook or desktop computer.
4. If necessary, configure your computer to work with an external USB mouse. See your computer documentation for details.

note

The remote mouse control function may not operate correctly on systems that have been upgraded from an earlier version of Windows.

note

For details on using the remote control in place of your computer's mouse, see page 41.

Use to move cursor



Left-click Right-click

Connecting an External Monitor

If you want to monitor your presentation close-up (on a monitor placed beside the projector) as well as on the screen, you can connect an external monitor.

To attach an external monitor, connect it to the projector's **Monitor Out** port, as shown:

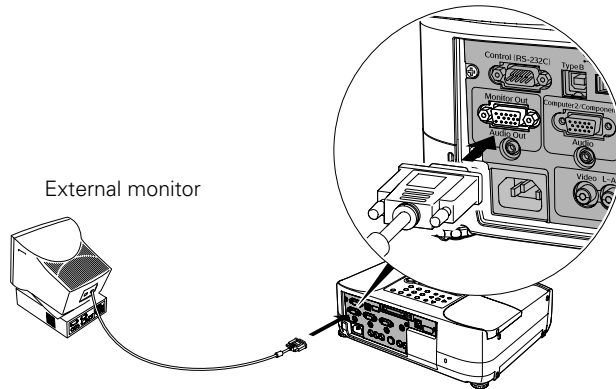

Follow these guidelines to view images on the monitor:

- The monitor displays the currently selected computer source. Press the **Preview** button on the remote control if you want to display all the active sources at the same time (see page 35).
- You can also view images on the monitor while the projector is in Standby mode, if you've set **Network ON** in the Extended menu (see page 75).

Connecting to Video Equipment

You can connect up to four video sources to the projector at the same time. Before starting, look at your video equipment to determine its available video output connections:

- If your video player has a yellow RCA-style video output connector, see “Connecting a Composite Video Source” on page 52.
- If your video player has an S-Video connector, see “Connecting an S-Video Source” on page 53.
- If your video player has a component video port (three connectors labeled either Y/Cb/Cr or Y/Pb/Pr), see “Connecting a Component Video Source” on page 54.
- If your video player has an RGB video port (either a single connector for a VGA-style monitor cable or three connectors labeled R/G/B), see “Connecting an RGB Video Source” on page 55.

After connecting video cables, you may also want to:

- Connect a monitor to the projector so you can view your presentation close-up as well as on-screen; see page 50.
- Connect an audio cable to play sound through the projector; see page 56.



RCA connector
(composite video)



S-Video
connector

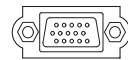

VGA connector
(RGB video)

Connecting a Composite Video Source

1. Locate the RCA-style video cable provided with the projector.
2. Connect the cable to the yellow video output connector on your player and the yellow **Video** connector on the projector:

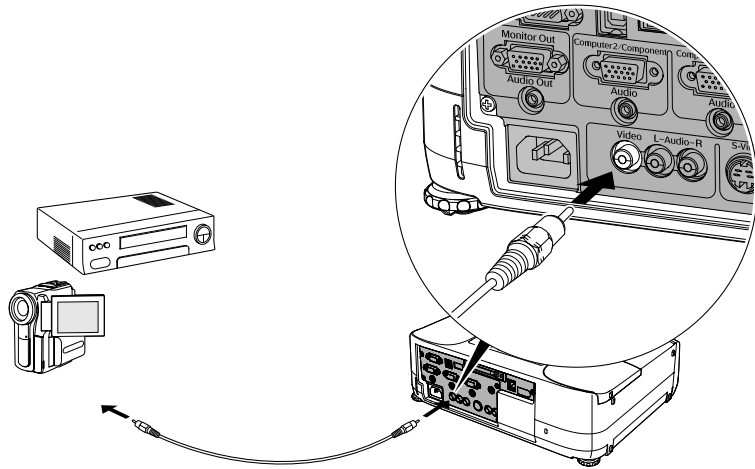

3. If you want to play sound through the projector, see page 56 for instructions on connecting an audio cable.
4. If you don't need to make any other connections, see page 18 or the *Quick Setup* sheet for instructions on turning on the projector and adjusting the image. Once the projector is turned on, select the image source: press the **Search** button on the remote control or press the **Source Search** button on the projector's control panel repeatedly until the image appears.

Connecting an S-Video Source

1. Locate an S-Video cable (one is usually provided with your video equipment or you can purchase one from Epson; see page 12).
2. Connect the cable to the S-Video connector on your player and the S-Video connector on the projector:

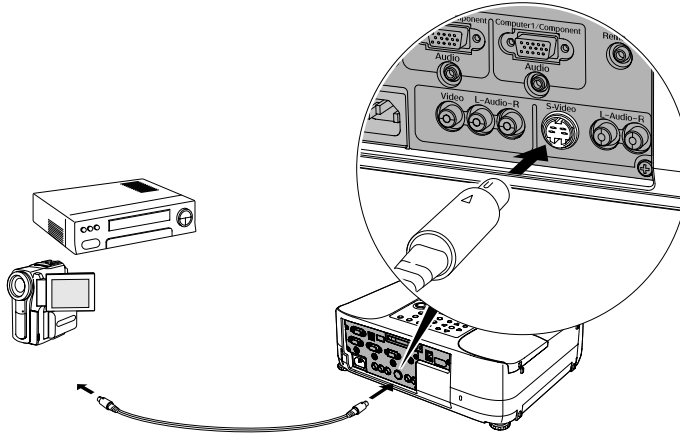

3. If you want to play sound through the projector, see page 56 for instructions on connecting an audio cable.
4. If you don't need to make any other connections, see page 18 or the *Quick Setup* sheet for instructions on turning on the projector and adjusting the image. Once the projector is turned on, select the image source: press the **Search** button on the remote control or press the **Source Search** button on the projector's control panel repeatedly until the image appears.

Connecting a Component Video Source

1. Locate a component-to-VGA video cable.
2. Connect the cable to your player and one of the Computer/Component connectors on the projector.

note

Be sure your video player is not an RGB video source. If you select the wrong source, image quality may suffer. Check your video player's documentation.

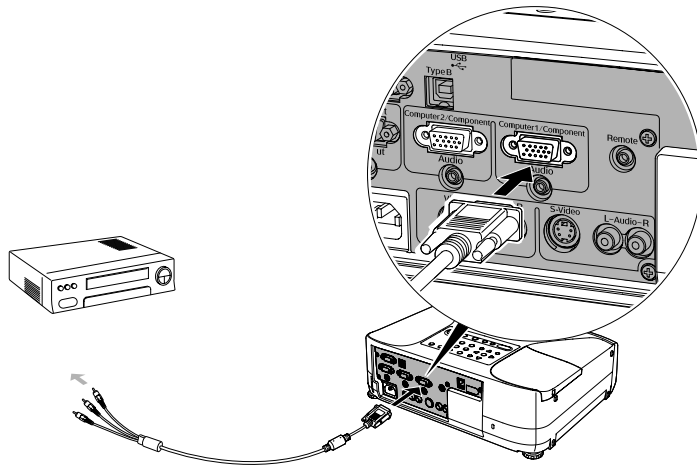

3. If you want to play sound through the projector, see page 56 for instructions on connecting an audio cable.
4. If you don't need to make any other connections, see page 18 for instructions on turning on the projector and adjusting the image. Once the projector is turned on, select the image source: press the Search button on the remote control or press the Source Search button on the projector's control panel repeatedly until the image appears.

Connecting an RGB Video Source

1. Locate the VGA computer cable provided with the projector.
2. Connect the cable to the video port on your player and one of the Computer/Component ports on the projector.

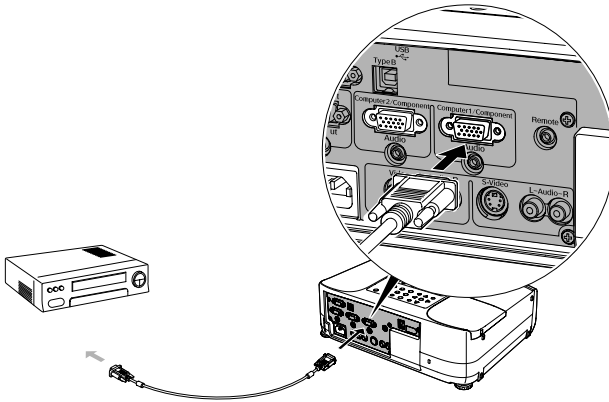

3. If you want to play sound through the projector, see page 56 for instructions on connecting an audio cable.
4. If you don't need to make any other connections, see page 18 for instructions on turning on the projector and adjusting the image. Once the projector is turned on, select the image source: press the **Search** button on the remote control or press the **Source Search** button on the projector's control panel repeatedly until the image appears.

note

Be sure your video player is not a component video source. If you select the wrong source, image quality may suffer. Check your video player's documentation.

Playing Sound Through the Projector

You can play sound through the projector's speaker system or attach an external speaker system. Attaching speakers to the projector instead of directly to the audio source lets you use the projector's remote control to adjust the sound.

Connecting Audio Equipment to the Projector

To play sound through the projector, follow these steps:

1. Locate the appropriate commercially available audio cable. Which cable you use depends on how your equipment is connected:
 - If you have a computer connected to a **Computer/Component** port, use a stereo mini-jack cable.
 - If you have video equipment connected to the **Video** or **S-Video** port, use an RCA-style audio cable.
2. Connect the audio cable to the jack corresponding to the connected video source.

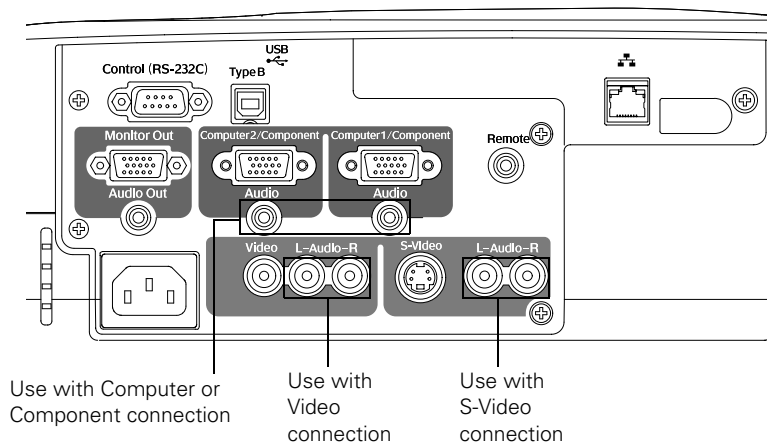

3. Connect the other end of the cable to the audio output connector on your computer or video equipment.

Connecting External Speakers

To connect speakers to the projector, follow these steps:

1. Locate the appropriate cable to connect your speakers.

Depending on your speakers you may be able to use a commercially available audio cable with a stereo mini-jack connector on one end and pin jacks on the other end. For some speakers, you may have to purchase a special cable or use an adapter.

2. Connect the stereo mini-jack end of the audio cable to the **Audio Out** port on the projector.

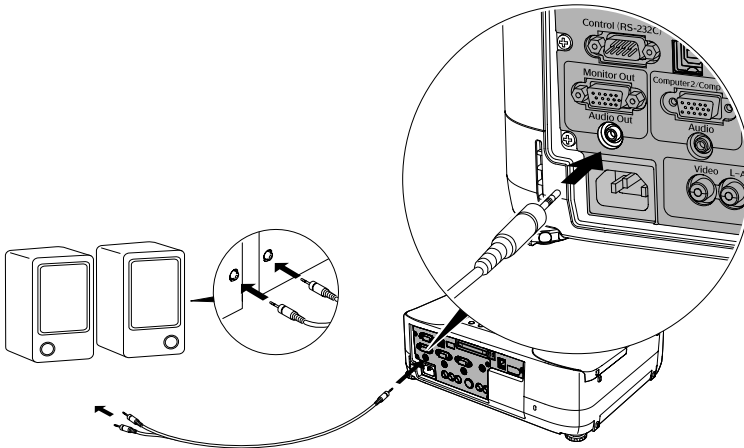

3. Connect the other end(s) of the cable to your speakers.

The projector's internal speaker system is disabled while sound is output to external speakers.

4

Fine-Tuning the Projector

You can use the projector's on-screen menus to adjust the image, sound, and other features. This chapter covers the following information:

- Using the menu system
- Adjusting the image quality
- Adjusting the image size, shape, and position
- Adjusting the color
- Adjusting the sound
- Using the projector security features
- Controlling multiple projectors
- Customizing projector features
- Enabling Quick Setup options

Using the Menu System

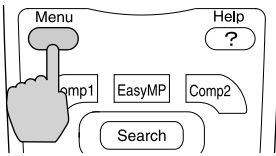

You can use the remote control or the projector's control panel to access the menus and change settings. Follow these steps:

1. To display the menu screen, press the **Menu** button.

You see a menu screen similar to the one below:

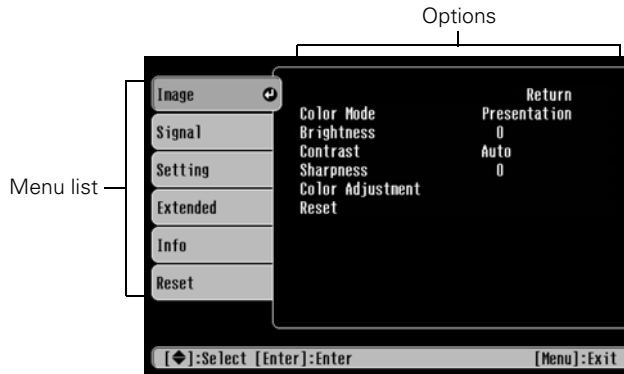

The menus are listed on the left and the options available for the highlighted menu are shown on the right.

2. Use the pointer button on the remote control (or the arrow buttons on the projector) to scroll through the menu list. When you've highlighted the desired menu, press the **Enter** button to select it.
3. Once you've selected the menu, use the pointer button to scroll through the list of options. (Some of the options may be grayed out or unavailable, depending on the selected source.)
4. After highlighting the option you want to adjust, use the pointer button to change the setting. In some cases, you may have to press the **Enter** button to view a sub-screen for changing the setting.



- Press the left or right side of the pointer button to adjust a slider bar.
- To select from two or more settings, use the pointer button to highlight the desired setting and press **Enter**.

5. After changing the settings, press the **Esc** button to save your changes and return to the previous menu (or press it repeatedly to exit the menu system).

You can also press the **Menu** button to exit.

Restoring the Default Settings

You can use the menu system's **Reset** options to restore the factory-default settings for all the settings listed in a specific menu, or all the settings in all menus.

To restore the settings in a specific menu, enter the menu whose settings you want to change, select **Reset**, and confirm as needed. (The example below shows how to reset the Settings menu.)

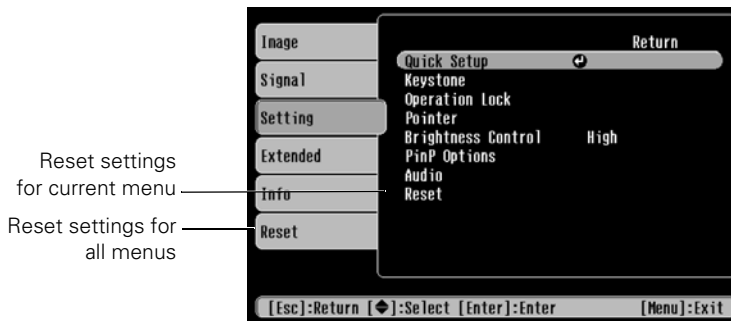

To restore all the projector settings to their factory-default values, select the **Reset** menu, highlight **All Reset**, and press **Enter**.

note

When you select All Reset in the Reset menu, it does not reset the Computer Input, User's Logo, Language, Projector ID, Network, and Lamp settings.

Adjusting the Image Quality

You can use the Video menu to adjust the brightness, sharpness, color, tint, and contrast. If you're projecting from a computer, there are additional adjustments you can make (see page 63).

Adjusting the Image

1. Press the Menu button on the remote control and select the Image menu. You see the Image menu screen.

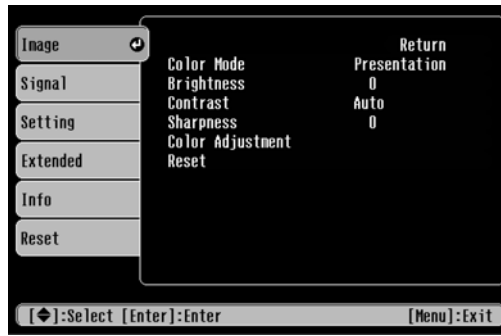

2. Use the  pointer button to highlight the desired option, then adjust it as needed:

- **Color Mode**

Lets you quickly adjust the color and brightness for various environments. Use either the remote control or the **Color Mode** setting in the Image menu. You can save a different setting for each computer and/or video source. Select from these settings:

Dynamic: For projecting movies or playing video games in vivid color in a bright room.

Presentation: For presentations in dark rooms.

Theatre: For optimizing movie images with natural color in a dark room (the default for video or S-Video display).

Living Room: For playing video games and watching TV in a bright room.

sRGB: For standard sRGB computer displays (the default when projecting from a computer with analog video).

- **Brightness**
Lightens or darkens the overall image.
- **Contrast**
Adjusts the difference between light and dark areas.
- **Sharpness**
Adjusts the sharpness of the image.
- **Color Adjustment**
Adjusts the tint of the image (not available for RGB video images).

Adjusting Signal Settings

Although the projector normally detects and optimizes the input signal automatically, you can use the Signal menu to make manual adjustments. In addition to changing the position of the projected image, you can correct tracking and sync for computer images, or change the aspect ratio to widescreen format for video images.

1. Press the **Menu** button on the remote control and select the **Signal** menu.

You see a screen similar to the one below. (The settings will be different depending on the source you are projecting from.)



note

The Brightness setting changes the opacity of the projector's LCD panels. You can also change the lamp's brightness. Select Brightness Control in the Setting menu, then choose High or Low (the default setting is High).

note

You can also use the remote control's Auto button to automatically reset the projector's tracking, sync, resolution, and position settings. See page 28 for details.

2. Use the  pointer button to highlight the desired option, then adjust it as needed:

- **Auto Setup**

Leave this setting **ON** to automatically optimize the computer image. Turn it off if you want to save adjustments you have made to the video settings.

- **Resolution**

If your image is distorted (compressed, stretched, partially cut off, or doesn't completely fill the display area), the projector's resolution setting may not match that of your computer. Select **Auto** to let the projector adjust the resolution automatically, or **Manual** to adjust the setting yourself. (Press **Enter** after you make the selection.)

- **Tracking**

Adjust this value to eliminate vertical stripes in the image.

- **Sync**

Adjust this value if the image appears blurry or flickers.

- **Position**

If the image is slightly cut off on one or more sides, it may not be centered exactly. Select this setting and use the  pointer button to center it.

- **Preset**

Once you've fine-tuned the settings in the Signal menu for the computer you're using, you can save them as a group using one of the ten **Preset** settings. The next time you use the same computer, simply press the **Preset** button on the remote control to recall your saved settings. (Press the **Preset** button repeatedly to select the number corresponding to the setting you want to use.)

- **Computer 1 Input/Computer 2 Input**

If the colors don't look right on the **Auto** setting, select the setting for the type of equipment you've connected to the **Computer/Component** port(s):

RGB: For a computer connection.

tip

Before adjusting tracking or sync, fill the screen with an image containing fine detail. For example, in Windows you can select a pattern to appear as your desktop background. If this option isn't available, try projecting black text on a white background.

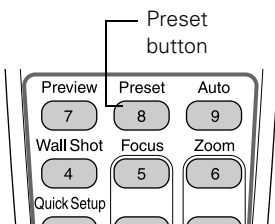

Component Video: For a video player that outputs a component video signal.

- **Video Signal**

Leave this setting at **Auto** unless you are using a 60-Hz PAL system (select **PAL60**).

Adjusting the Image Size, Shape, and Position

Whether you're projecting from a computer or video player, you can use these settings to adjust the size, shape, and position of the image.

- **Resize button**

Adjusts how an image fits into the display area.

For computer images, resizing is normally unnecessary, since the projector automatically resizes the image to make the best use of the display area. If you press the **Resize** button on the projector or remote control, the projector displays the image at the output resolution of the computer (which makes the image larger or smaller, depending on its resolution). If the resolution of the image is the same as the projector's (1024 × 768), pressing **Resize** has no effect.

For video images, pressing **Resize** switches the aspect ratio between 4:3 and 16:9. This lets you play certain digital video images or movies recorded on certain DVDs in 16:9 widescreen format.

- **Keystone** (in the Setting menu)

Squares up the shape of the image after the projector has been tilted upward or angled to one side (see page 26). If you notice lines or edges looking jagged after adjusting the shape, decrease the Sharpness setting (see page 62).

- **Position** (in the Signal menu)

If the image is slightly cut off on one or more sides, it may not be centered exactly. Select this setting and use the  pointer button to center it (not available for digital RGB or RGB video images).

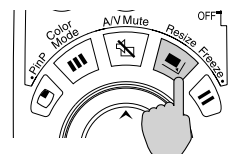

note

If your computer image is stretched, compressed, or doesn't fit correctly on the screen, try adjusting the Resolution setting first (see page 64).

Adjusting the Color

The projector provides several ways for you to adjust the color:

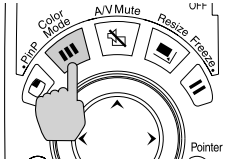

- **Color Mode button** (also in the Image menu)
Lets you quickly adjust the color and brightness for various environments. Use either the remote control or the **Color Mode** setting in the Image menu. You can save a different setting for each computer and/or video source. Select from these settings:
 - **Dynamic:** For projecting movies or playing video games in vivid color in a bright room.
 - **Presentation:** For presentations in dark rooms.
 - **Theatre:** For optimizing movie images with natural color in a dark room (the default for video or S-Video display).
 - **Living Room:** For playing video games and watching TV in a bright room.
 - **sRGB:** For standard sRGB computer displays (the default when projecting from a computer with analog video).
- **Color Adjustment** (in the Setting menu)
Adjusts the color temperature. Select **Color Temp.** to set a temperature between 5000 and 10000 °K. Or select **RGB** to adjust individual red, green, and blue values. (Not available if sRGB is selected as the Color Mode setting.)

Adjusting the Sound

You can use the Audio settings to adjust the sound volume or tone.

1. Press the **Menu** button on the remote control and select the **Setting** menu.
2. Choose **Audio** and press **Enter**.

You see the Audio menu settings:



3. Use the  pointer button to highlight the desired option, then adjust it as needed:
 - **Volume**
Adjusts the volume.
 - **Tone**
Adjusts the quality of the sound.

Using the Projector Security Features

To prevent unauthorized use of the projector, you can do the following:

- Assign a password; this can be disabled for a set period if you want to loan the projector to someone. See page 68.
- Create an identifying user logo that is displayed at startup and/or when the **A/V Mute** button is pressed. See page 71.
- Disable the projector's buttons; this is useful, for example, if you're projecting in a classroom and you want to ensure that no one touches the projector's buttons while you're using the remote control. See page 72.

note

You can also adjust the volume using the remote control.

If you create a user's logo for the projector, you can set up the logo so it is displayed as the startup screen and/or AV/Mute screen. Unauthorized users cannot turn it off or change it. This feature is intended to discourage theft and provides a way to identify the projector should it be stolen.

Enabling Password Protection

To prevent unauthorized use, you can assign the projector a password. If you do, a screen will appear requesting the password whenever the projector is plugged in and turned on. If an incorrect password is entered three times in succession, the projector's operation is locked and the power cord must be disconnected and reinserted to redisplay the password screen. If an incorrect password is entered thirty times in succession, the user must contact Epson to unlock the projector.

The default setting for the Password Protect function is OFF. Follow these steps to turn password protection on:

1. Press the **Freeze** button on the remote control for about five seconds.

You see this screen:



2. Use the  pointer button to set Power ON Protect to ON. Then press **Enter**.
3. Select **Password** and press **Enter**.
4. When you see a message asking if you want to change the password, select **Yes** and press **Enter**.

note

It's a good idea to write down your password.

If you leave the projector plugged in, the Password Protect Release screen will not appear. You only need a password if you unplug and reconnect the power cable.

caution

If you lose the remote control, you will not be able to enter the password. Keep the remote control in a safe place at all times.

5. Press the **Num** button on the remote control. When it lights, the numeric keypad is activated.
6. Use the numeric keypad to enter a four digit password. (The default setting is 0000.)
7. When you see a confirmation message, reenter the password. Then press the **Menu** button to exit the screen.
8. Press the **Num** button on the remote control to deactivate the numeric keypad.
9. If you want to disable the password temporarily, select **Timer** and press **Enter**. Then hold down the **Num** button while you use the numeric keypad to enter the number of hours (from 0 to 9999) that you want the password feature disabled. If you want the projector to request the password every time it is turned on, set the timer to **0H**.

The countdown for the elapsed time begins as soon as you close the Password Protect menu. (You can check the elapsed time in this menu next to **Time elapsed**.)

10. To enable your screen logo, select **User's Logo Protect** and press **Enter**. Select **ON** and press **Enter**.

When this feature is on, the logo appears whenever you turn on the projector (if the **Startup Screen** is enabled in the Extended menu; see page 71). It also appears when you press the A/V Mute button (if you selected the **Logo** as the Background Color in the Extended menu). None of the User's Logo features in the Extended menu can be changed when the User's Logo Protect function is enabled.

Starting the Projector with a Password

When the password function is enabled, you see this screen when you plug in and turn on the projector:



1. Press the **Num** button on the remote control to activate the numeric keypad.
2. Enter the four digit password.

The password screen closes, the numeric keypad is automatically deactivated, and projection begins.

If the password is not correct, you see the message **Wrong password. Please try again.** If you enter an incorrect password three times in succession, you see the message **The projector's operation will be locked. Request code xxxxx** and the projector switches to standby mode for approximately 5 minutes. Write down the request code. Then disconnect the projector's power cord from the electrical outlet, reconnect it, and turn the projector back on.

When you see the Password Protect Release screen again, you can try to enter the correct password.

If you have forgotten the password, contact Epson with the request code number that appears in the Password Protect Release screen for assistance. See "Where To Get Help" on page 112.

If you enter an incorrect password 30 times in succession, the projector remains locked and you must contact Epson to unlock it.

Creating Your Own Startup Screen

You can transfer any image from your computer or video source to the projector and then use it as your startup screen. You can also use it as the screen displayed when the projector is not receiving a signal or when you press the **A/V Mute** button. The image can be a company logo, slogan, photograph, or any other image you want to use.

Capturing the Image

Start by displaying the image you want to use from either a computer or video source, such as a DVD player. Then follow these steps to capture the image and transfer it to the projector:

1. Press the **Menu** button on the remote control, highlight the **Extended** menu, and press **Enter**.
2. Highlight **User's Logo** and press **Enter**.

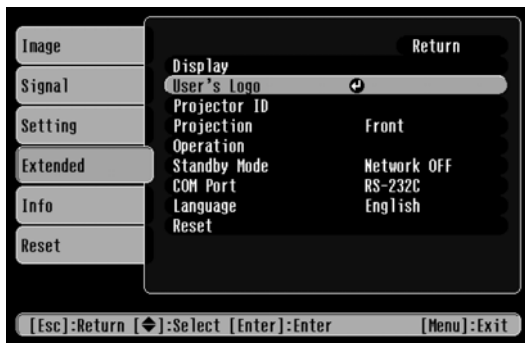

3. When you see a message asking whether you accept the present image as the user's logo, select **Yes** and press **Enter**. A selection box displays over the image.
4. Use the  pointer button to select the area of the image you want to use. Then press **Enter**.
5. When you see the message **Select this Image?**, highlight **Yes** and press **Enter**.
6. Use the arrow buttons to select a zoom rate (display size) and press **Enter**.

7. When the message **Save image as user's logo?** appears, select **Yes** and press **Enter**. Saving the logo may take a few moments. Do not use your projector or video source while the logo is being saved.
8. When you see the message **Completed**, press **Esc** to return to the menu screen.

Choosing When to Display the Image

After your image is saved, it is automatically set as the startup screen. You can also save it as the screen you see when there's no signal or when you press the **A/V Mute** button (see page 37).

1. Press the **Menu** button, highlight the **Extended** menu, and press **Enter**.
2. Select **Display** and press **Enter**.
3. Select the screen(s) on which you want your image to appear:
 - Highlight **Display Background** to display your image (instead of a blank screen) when there is no video signal coming from the currently selected source. Then press **Enter**.
 - Highlight **A/V Mute** to display your image when you press the **A/V Mute** button. Then press **Enter**.
4. Select **Logo** and press **Enter**.
5. When you're finished, press **Esc** to exit.

Disabling the Projector's Buttons

When you enable the **Operation Lock** function, you can lock all the projector's buttons, or you can lock some of the projector's buttons.

1. Press the **Menu** button, highlight the **Setting** menu, and press **Enter**.
2. Select **Operation Lock** and press the **Enter** button.
3. Select **Full Lock** or **Partial Lock** and press **Enter**.
4. Select **Yes** and press **Enter** to confirm the setting.
5. Press the **Menu** button to exit.

Controlling Multiple Projectors

If you're using more than one projector for your presentation, you can switch between them using a single remote control. To do this, you need to set a different ID for each projector. During the presentation, you can change the remote control's ID to match that of the projector you want to use.

Setting the Projector ID

The projector's default ID is 1. Follow these steps to change it:

1. Press the **Menu** button on the remote control.
You see the projector's menu screen.
2. Select the **Extended** menu and press **Enter**.
3. Highlight **Projector ID** and press **Enter**.

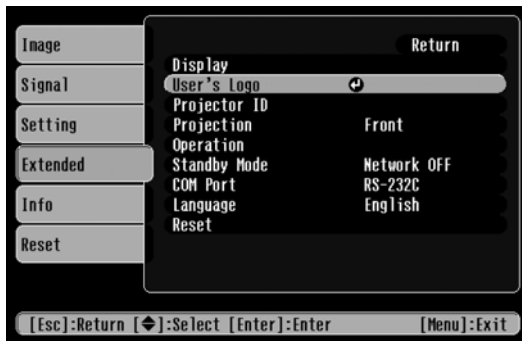

4. Choose an ID value for the projector and press **Enter**.
5. When you're done, press **ESC** to exit the menu system.

note

By default, the remote control's ID is set to zero, which allows it to control any projector. If you want to control multiple projectors simultaneously, and you don't want to switch between them (each projector would need its own screen), you can leave the remote control's ID set to zero.

Changing the Remote Control ID

To change the remote control's ID to match the projector's ID, follow these steps:

1. Press the ID button on the remote control. You see it light.
2. Press one of the numbered buttons on the remote control to select the ID of the projector you want to operate.

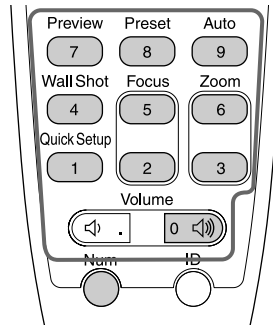
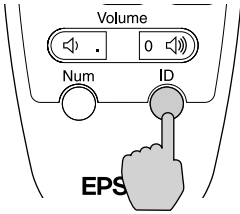

The ID button's light shuts off and the new ID is registered.

3. Repeat steps 1 and 2 each time you want to switch projectors.

To check the remote control's current ID, do the following:

1. Press the ID button twice. After a moment, the button flashes.
2. Count the number of flashes; this number corresponds to the remote control's ID. (If it doesn't flash, the ID is set to zero.)

Customizing Projector Features

You can use the menu system to turn standby mode on or off, adjust the network settings, change the language, and customize the way the projector displays images.

Remote Monitoring Setup Options

These options let you set up the projector so it can be monitored and controlled from a remote computer (see page 80).

- **Standby Mode** (in the Extended menu)
Select **Network ON** to enable the projector to be monitored over a network when it's in standby mode.
- If you want to monitor the projector using a network management utility, select **SNMP** in the Network menu and enter at least one trap IP address.

Miscellaneous Setup Options

- **Projection** (in the Extended menu)
Select **Front** (to project from the front of a screen and right side up), **Front/Ceiling** (when the projector is mounted upside-down from the ceiling), **Rear** (to project from behind onto a transparent screen), or **Rear/Ceiling** (to project from behind onto a transparent screen when the projector is mounted upside-down from the ceiling).
- **Language** (in the Extended menu)
Select from nine languages to be used for the projector menus.

note

When Standby Mode is set to Network ON, the exhaust fan continues to operate after the projector has cooled down. This is normal.

Enabling Quick Setup Options

Your projector can quickly detect and set up the focus, straighten the image, and adjust the colors for the surface the image is being projected on. Follow these steps to enable these features:

1. Press the **Menu** button on the remote control.
You see the projector's menu screen.
2. Select the **Setting** menu and press **Enter**. Then highlight **Quick Setup** and press **Enter**.
3. Select **Quick Setup Options** and press **Enter**.

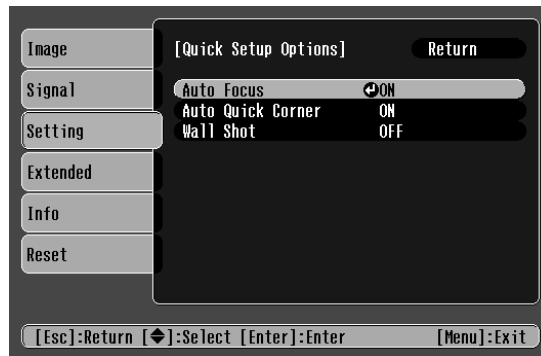

4. Adjust any of these options:
 - Highlight **Auto Focus** to automatically focus the projector.
 - Highlight **Auto Quick Corner** to automatically straighten the image if it is not rectangular.
 - Highlight **Wall Shot** to project on walls or surfaces that are not white.
5. Press **Enter**, then highlight **ON** or **OFF** and press enter. Highlight **Return** and press **Enter**.
6. When you are done adjusting settings, press the **Menu** button to exit.

Automatically Running Quick Setup

To automatically run quick setup whenever you turn on the projector, follow these steps:

1. Press the **Menu** button on the remote control.
You see the projector's menu screen.
2. Select the **Setting** menu and press **Enter**. Then select **Quick Setup** and press **Enter**.
3. Select **Startup Options** and press **Enter**.
4. Select **Quick Setup** and press **Enter**.

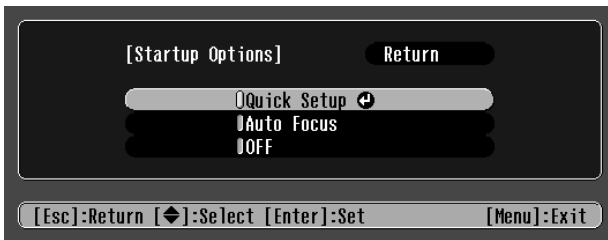

5. Press the **Menu** button to exit.

5 *Managing Projectors*

The EasyManagement software for your projector lets you monitor and control your projectors from a remote computer:

note

If you're using a network management utility running SNMP, you can configure your network to send trap alerts even without a plug-in (see page 80). This feature is intended for use by network administrators only.

- Use EMP Monitor (available for Windows only) to see your projectors' status, switch image sources, and control basic settings.
- Use EMP NetworkManager to send out messages by e-mail, notifying you when a problem occurs with a projector.
- Use a network management utility running SNMP, such as HP OpenView, to manage your facility's equipment from a pre-existing system.

To use the EasyManagement software to manage your projectors, first install EMP Monitor as described on page 114. Then connect and configure each projector you want to monitor. You can connect the projector over a wired network (as described on page 80).

This chapter covers the following information:

- Connecting the projector to and configuring it for a wired network
- Monitoring and controlling your projector with EMP Monitor
- Using a browser to monitor the projector

Connecting and Configuring the Projector on a Wired Network

note

If you're a network administrator, you can use the **SNMP** option to enter a trap IP address. This lets you receive trap alerts for the projectors you're monitoring.

Before using the EasyManagement software to manage your projector(s), you have to connect each projector you want to monitor to your network and configure it with an appropriate IP address. You can connect and configure the projector using the network port.

Follow these steps to connect and configure the projector for your network.

1. Connect the projector to your network using a commercially available 100baseTX or 10baseT network cable.
2. Turn on the projector (see page 18).
3. Press the **Menu** button on the remote control and select **Network** from the **Extended** menu.
4. If your network assigns addresses automatically, turn on **DHCP**.

If your network does not assign addresses automatically, turn off **DHCP** and enter the projector's **IP Address**, **Subnet Mask**, and **Gateway Address**, as needed.

- To enter numbers using the remote control, press the **Num** button until it lights, then use the number keypad shown below.

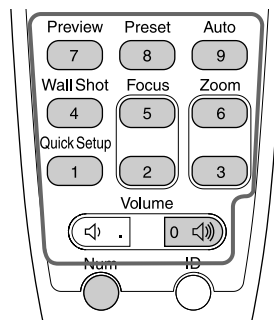

- To change the network addresses from the projector's control panel, press the right and left arrow buttons to select the part of the address you want to enter, then use the up and down arrow buttons to increase or decrease the numeric value.

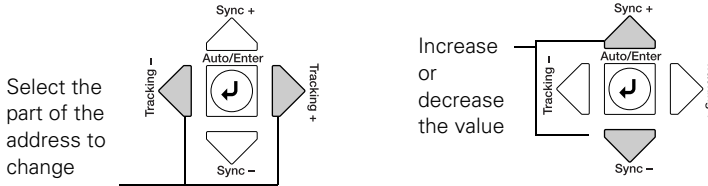

When you finish changing an address in the network menu, press the **Enter** button (on the remote control) or the **↵ Auto/Enter** button (on the projector).

5. When you're done, press **Esc** to exit the menu system.

Using EMP Monitor

EMP Monitor lets you use a remote computer to manage your projectors over a wired network. It lets you easily turn the projectors on or off (together or individually), switch image sources, and check their status.

Before using EMP Monitor, make sure you've installed the software (available for Windows only) as described on page 114. The computer you're using to monitor the projector should already be connected to your network.

note

*If you want to monitor projectors while they are in standby mode, select **Standby Mode** in the **Extended menu**, then select **Network ON**. See page 75.*

Opening and Closing EMP Monitor

To start EMP Monitor, click **Start > Programs or All Programs > Epson Projector > EMP Monitor**.

If you've added the program to the Startup programs folder, then it may already be open. If so, click the icon in the system tray on the lower-right corner of your screen to display the EMP Monitor window:



To close EMP Monitor, right-click the program icon shown above and select **Exit**.

Registering Your Projectors

Before you can monitor your projectors, follow these steps to register them:

1. Click **Start > Programs or All Programs > Epson Projector > EMP Monitor** or click the EMP Monitor icon in the taskbar. You see this screen:

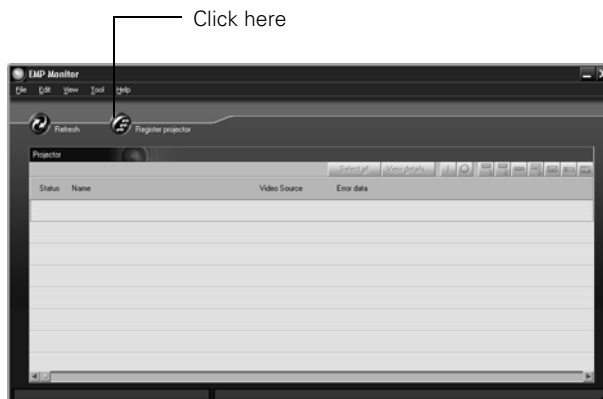

note

To delete a projector from the list, highlight the projector name, and click Delete.

You see this screen with a list of all registered projectors.

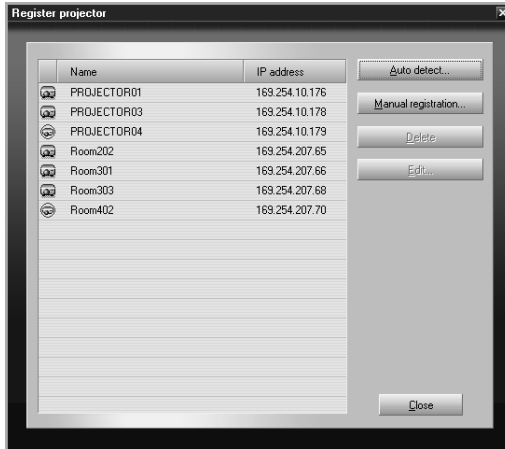

5. Click **Close**.

You see the status of each of your registered projectors on the main EMP Monitor screen:



Monitoring Your Projectors

The EMP Monitor screen lets you monitor your projectors using the Status, Video Source, and Error icons shown below. These let you see which projectors are currently being used, from which source (or port) they are projecting an image, and if a problem occurs.



Status icon



Video Source
icon

Error icon

For detailed status information, select the projector and click **View details**.

The following table explains the meaning of the status icons:

Status icons



 (green)	Projecting; no problems
 (dark)	Turned off; no problems
 (green)	Projecting; problems detected

note

*To monitor a projector when it's in standby mode (plugged in but not turned on), you must select **Network ON** as the **Standby Mode** setting in the projector's **Extended menu** (see page 75).*





*Remember that when **Standby Mode** is set to **Network ON**, the exhaust fan continues to operate after the projector has cooled down. This is normal.*

Status icons

 (dark)	Turned off; problems detected
	Network error (for example, not connected to the network or power cable disconnected). You may also see this error if Network OFF is selected in Standby Mode (see page 75).







The following table explains the meaning of the video source icons:

Video source icons

	Computer/Component 1
	Computer/Component 2
	S-Video
	Video
	EasyMP (Not functional for the PowerLite 830p)

The following table explains the meaning of the error icons. See page 101 for recommended solutions to problems.

Error icons

	Lamp replacement notification (the lamp is nearing the end of its life; see page 97)
	High-speed cooling in progress (the projector is getting too hot but continues to operate)
	Overheating (projection turned off automatically)
	Lamp out or lamp cover open
	Fan error
	Sensor error
	Internal problem

Controlling Your Projectors

The control buttons in the upper-right let you select video signals and turn projectors on or off. (Hold the mouse pointer over a button to see a description of its function.) Select the projector you want to operate (with the mouse pointer) before clicking one of the buttons.

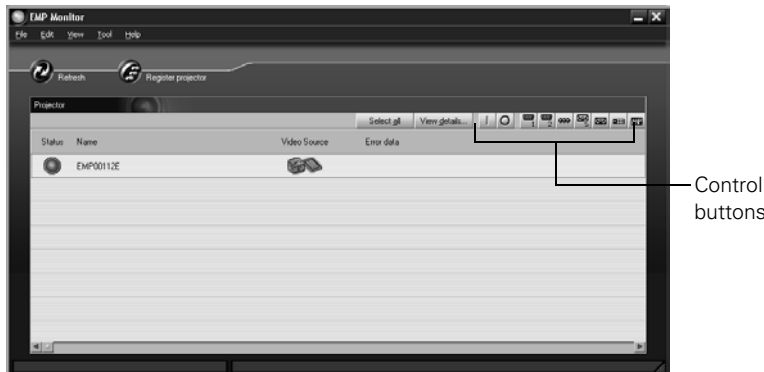







note

To turn on a projector when it's in standby mode (plugged in but not projecting), you must have selected **Network ON** as the **Standby Mode** setting in the projector's **Extended menu** (see page 75).

Remember that when **Standby Mode** is set to **Network ON**, the exhaust fan continues to operate after the projector has cooled down. This is normal.

The following table explains the functions of the control buttons:

Control buttons

	Turns the projector on
	Turns the projector off
	Changes the video signal to the Computer/Component 1 port
	Changes the video signal to the Computer/Component 2 port
	Changes the video signal to the S-Video port
	Changes the video signal to the Video port
	Switches the display to EasyMP (Not functional for the PowerLite 830p)

Using EMP NetworkManager

You can use EMP NetworkManager to send out messages by e-mail, notifying you when a problem occurs with a projector. Before running EMP NetworkManager, make sure you've installed the software as described on page 114. Then follow the steps below to create e-mail settings for each projector you want to monitor.

Selecting the Projectors to Monitor

1. To start EMP NetworkManager, click **Start > Programs** or **All Programs > EPSON Projector > EMP NetworkManager**.

You see the EMP NetworkManager screen. The projectors you've already registered through EMP Monitor appear as icons.

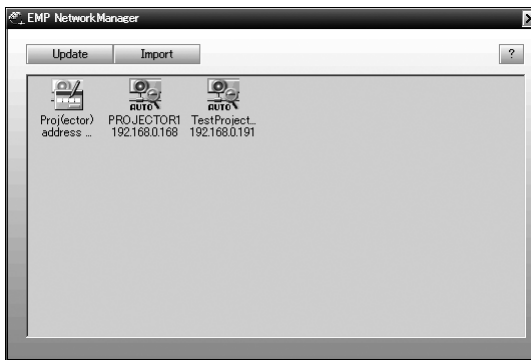

2. If you'd like to register a projector manually and you know its IP address, double-click the  Projector address selection icon. You see this screen:

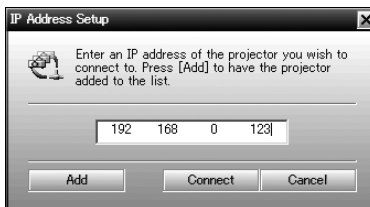

3. Enter the projector's IP address and click **Add**. The projector's icon is added to the EMP NetworkManager screen.

Setting a Password

note

Entering a password in EMP NetworkManager will automatically assign that password in EMP Monitor.

You can set a password to restrict access to each projector from EMP NetworkManager:

1. Right-click the icon of the projector whose password you want to set, then select **Change Password**.



2. Enter a password up to 14 characters in length.

Creating the E-Mail Settings

1. If EMP NetworkManager is not already running, open it from the Start menu. You see your registered projectors displayed as shown:

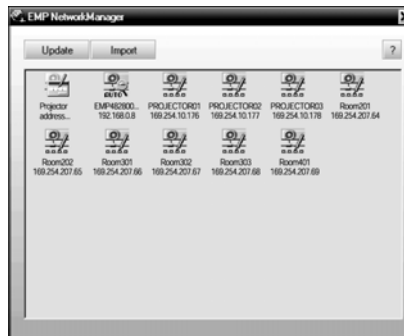

2. Double-click the icon for the projector whose e-mail settings you want to create. Enter your password, if you created one (see above).

3. EMP NetworkManager connects to the projector, and you see this screen:

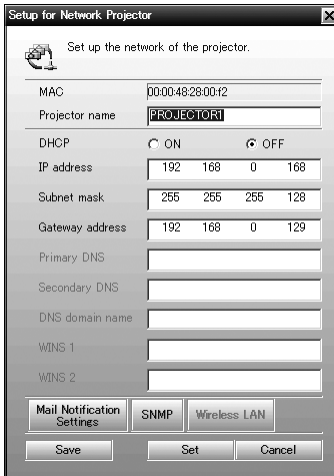

4. Verify that the network settings are correct. (If DHCP is on, you don't need to verify network settings.)
 - Make any desired changes to the projector's network address configuration (turning off DHCP enables the manual settings).
 - You can give the projector a name—up to 15 characters long, including the following symbols: ! @ # \$ % ^ & ' . - _ { } ~
Naming the projector helps you identify it in EMP Monitor and EMP NetworkManager, especially if you're managing more than a few of them.
5. Click Mail Notification Settings.

note

The projector must be plugged in (projecting or in standby mode) for you to be able to connect to it.

*To access a projector in standby mode, you must select **Network ON** as the **Standby Mode** setting in the projector's menu system (see page 75).*

*Remember that when **Standby Mode** is set to **Network ON**, the exhaust fan continues to operate after the projector has cooled down. This is normal.*

You see this screen:



6. Select **ON** for the Mail Notification setting.
7. Enter the IP address and port number of the SMTP server used for sending e-mail. (The port's default setting is 25, but you can enter any number from 1 to 65535.)
8. Enter up to three e-mail addresses where you want the event notification messages to be sent.
9. Click the **Setting a Notification Event** button next to each address, then select the conditions under which you want a message to be sent.
10. Click **OK**, then click **OK** again on the next screen. Click **Set** on the Setup for Network Projector screen and confirm as needed.
11. When you see the test message window, you can send a message with the heading "TEST MAIL" to the addresses you have entered. The projector's name and IP address are included in the body of the message.
12. When done making all your projector settings, close EMP NetworkManager. (It does not have to be open for messages to be sent or received.)

note

A no-signal message is reported when no image signals are being input to a projector. If the projector will not normally be displaying an image, do not select "no signal" as a condition for which you want a message to be sent.

Understanding the Notification Messages

If a projector experiences a problem, it sends an e-mail message to each of the addresses you provided using EMP NetworkManager. The message includes the heading “EPSON Projector” in the subject line.

The body of the message contains:

- the name of the projector
- the projector’s IP address
- a description of the problem

The problem descriptions are similar to the errors reported by EMP Monitor listed on page 87.

If a plus (+) sign appears before the description, it indicates that a problem has occurred. A minus (–) sign appears when the problem goes away or is resolved.

note

If a projector develops a critical problem, it may not be possible for it to report the error.

6

Maintaining the Projector

warning

Before you clean any part of the projector, turn it off and unplug the power cord.

Never open any cover on the projector, except the lamp cover. Dangerous electrical voltages in the projector can injure you severely. Do not try to service this product yourself, except as specifically explained in this User's Guide. Refer all other servicing to qualified service personnel.

Your projector needs little maintenance. All you have to do is keep the lens clean and periodically clean the air filters at the side and base of the projector. A clogged air filter can block ventilation needed to cool the projector.

The only parts you should replace are the lamp and air filters. If any other part needs replacing, contact your dealer or a qualified servicer.

This chapter covers the following:

- Cleaning the lens
- Cleaning the projector case
- Cleaning the air filters and vents
- Replacing the lamp and air filters
- Transporting the projector

Cleaning the Lens

Clean the lens whenever you notice dirt or dust on the surface.

Use a canister of compressed air to remove dust.

To remove dirt or smears on the lens, use lens-cleaning tissue. If necessary, moisten a soft cloth with lens cleaner and gently wipe the lens.

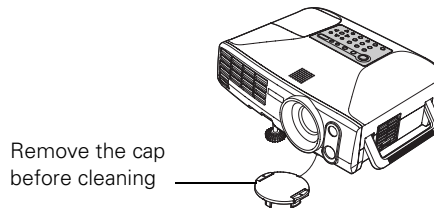

Cleaning the Projector Case

caution

Do not use wax, alcohol, benzene, thinner, or other chemical detergents. These can damage the case.

Before you clean the case, turn off the projector and unplug the power cord.

- To remove dirt or dust, wipe the case with a soft, dry, lint-free cloth.
- To remove stubborn dirt or stains, moisten a soft cloth with water and a neutral detergent. Then wipe the case.

Cleaning the Air Filters and Vents

note

To order replacement air filters, request part number V13H134A07. See page 13 for ordering information.

Clean the air filters and air intake vents after every 100 hours of use. If they are not cleaned periodically, they can become clogged with dust, preventing proper ventilation. This can cause overheating and damage the projector.

Follow these steps:

1. Turn off the projector. Wait for the Power light to stop flashing, then unplug the power cord.
2. To clean the intake vents, use a small vacuum cleaner designed for computers and other office equipment. If you don't have one, gently clean the vents with a soft brush (such as an artist's paintbrush).

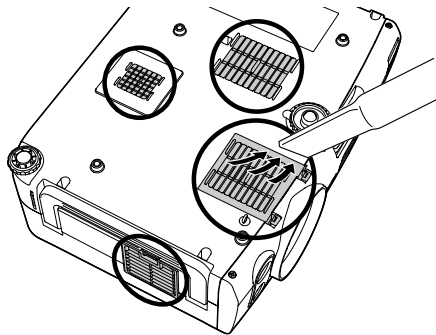



3. If the dirt is difficult to remove or a filter is broken, replace the filters as described on the next page. Contact your dealer or call Epson at (800) 873-7766 in the United States to obtain new ones. In Canada, please call (800) 463-7766 for dealer referral.

Replacing the Lamp and Air Filters

The life span of the projection lamp is about 2000 hours if **Brightness Control** in the Setting menu is set to **High** (default), and 3000 hours if **Brightness Control** is set to **Low**.

It is time to replace the lamp when:

- The projected image gets darker or starts to deteriorate.
- The message **Replace the lamp** appears on the screen when the lamp comes on and the lamp warning light  flashes orange. To maintain projector brightness and image quality, replace the lamp as soon as possible.
- The lamp warning light  flashes red (the lamp is burnt out).

Contact your dealer or call Epson at (800) 873-7766 in the United States for a replacement lamp. Request part number V13H010L31. In Canada, please call (800) 463-7766 for dealer referral.

Follow these steps to replace the lamp and air filters:

1. Turn off the projector.
2. When the **Power** light stops flashing, unplug the power cord.
3. Let the projector cool for at least an hour (if it has been on). The lamp is extremely hot immediately after use.

note

When you get a replacement lamp for your projector, you should replace the filters.

To check how long the lamp has been in use, see page 105.

warning

Let the lamp cool fully before replacing it.

In the unlikely event that the lamp has broken, small glass fragments may be present and should be removed carefully to avoid injury.

- Turn the projector over and remove the air filters at the side and bottom of the projector.

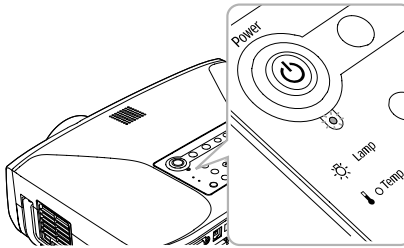

- Insert the two new air filters. They should click into place.
- Turn the projector back over.
- Loosen the screw holding the lamp cover in place (you don't need to remove it). Then remove the lamp cover.

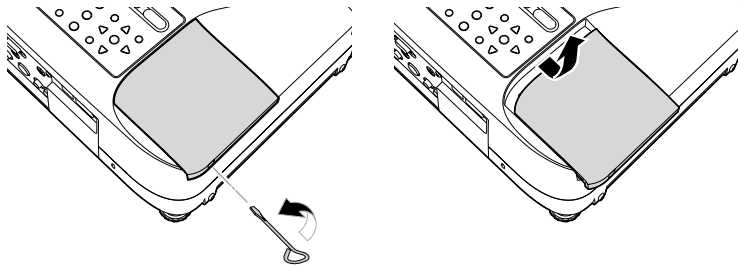

- Loosen the two screws holding the lamp in place (you don't need to remove them).

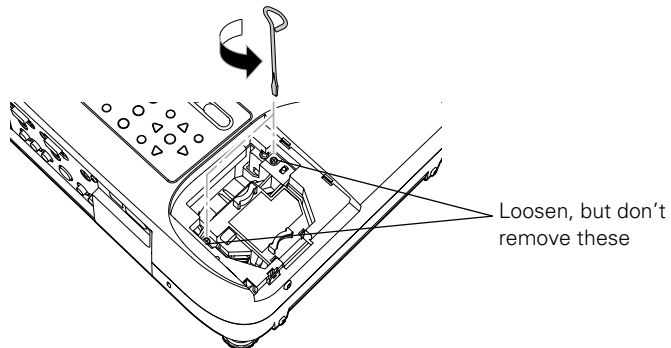

9. Grasp the handles as shown and pull the lamp straight out.

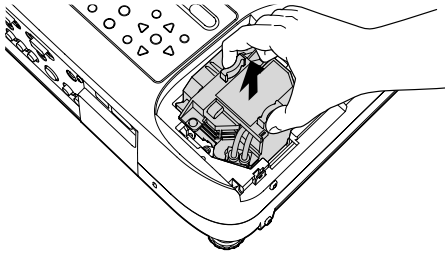

10. Gently insert the new lamp. (If it doesn't fit easily, make sure it is facing the right way.)
11. Once the lamp is fully inserted, tighten its screws and replace the cover, then tighten the cover screw. (The projector won't come on if the lamp cover is loose.)
12. Reset the lamp timer as described in the next section.

Resetting the Lamp Timer

After you replace the lamp, you need to reset the lamp timer using the projector's menus.

1. Press the **Menu** button on the remote control or on the projector's control panel. You see the main menu.
2. Use the  pointer button on the remote control (or the arrow buttons on the projector) to highlight **Reset**, then press **Enter**.

You see this screen:



3. Select **Lamp Hours Reset** and press **Enter**. You see this prompt:

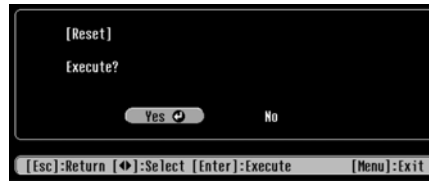

4. Select **Yes** and press **Enter**.
5. When you're finished, press **Esc** or **Menu** to exit.

Transporting the Projector

The projector contains many glass and precision parts. Follow these guidelines to prevent damage:

- When shipping the projector for repairs, use the original packaging material if possible. If you do not have the original packaging, use equivalent materials, placing plenty of cushioning around the projector.
- When transporting the projector a long distance, first place it in a hard-shell shipping case, then pack it in a firm box with cushioning around the case. (An optional case is available from Epson; see page 13.)

note

Epson shall not be liable for any damages incurred during transportation.

7

Solving Problems

This chapter helps you solve problems with your projector, and tells you how to contact technical support for problems you can't solve yourself. The following information is included:

- Using the projector's on-screen help system
- What to do when the projector's status lights flash
- Solving problems with the image or sound
- Solving problems with EasyManagement
- Solving problems with the remote control
- Contacting technical support

Using On-Screen Help

If the image doesn't look right or your audio isn't working, you can get help by pressing the blue ? Help button on top of the projector or on the remote control. The following choices are available:

- Problems with image
- Problems with sound
- Language change

Follow these steps to get help:

1. Press the blue ? Help button on the projector.



You see the Help Menu:

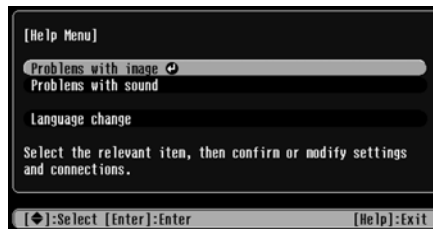

2. Use the  pointer button on the remote control or the arrow buttons on the projector to highlight menu items.
3. Press the **Enter** button on the remote control or on the projector to select the menu item.
4. To exit the help system, press the ? Help button.

If none of the suggestions solve your problem, see additional solutions to problems in the following sections.

Checking Projector Status

If your projector isn't working correctly, first turn it off, wait for it to cool (the **Power** light stops flashing orange), and unplug it. Then plug the power cord back in and turn on the projector. If this doesn't solve the problem, check the lights on top of the projector.





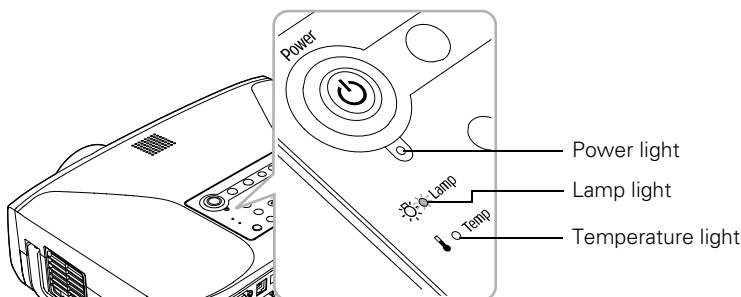

What To Do When the Lights Flash

The lights on top of the projector indicate the projector's status.









Refer to the following table for a complete description of the projector's status lights:

Status lights

Light	Status	Description
	Orange	The projector is in sleep mode. You can unplug it or press the  Power button to turn it on.
	Flashing green	The projector is warming up. Wait for the image to appear.
	Green	The projector is operating normally.
	Flashing orange	The projector is cooling down. You can't turn it back on (and you should not unplug it) until the light stops flashing and remains orange.
	Flashing red	There is a problem with the fan or temperature sensor. Stop using the projector, disconnect the power cable, and contact Epson.

Status lights

Light	Status	Description
	Flashing orange	Rapid cooling is in progress. Although this is not an abnormal condition, projection will stop automatically if the temperature rises higher. Make sure there is plenty of space around and under the projector for ventilation, and that the air filters and vents are clear.
	Red	<p>The projector is overheating, which turns the lamp off automatically. Wait until the cooling fan stops, then unplug the power cord. Plug the power cord back in and press the  Power button. Make sure the room temperature is not above 95 °F (35 °C), and there is plenty of space around and under the projector for ventilation.</p> <p>The air filters may be clogged. Clean or replace them as described on page 96.</p> <p>If the projector continues to overheat after you clean the air filter, the problem may be caused by damage to the cooling fan or temperature sensor. Contact Epson for help.</p> <p>Warning: Except as specifically explained in this <i>User's Guide</i>, do not attempt to service this product yourself.</p>
	Flashing orange	It's time to replace the lamp. See page 97 for instructions. If you continue to use the lamp after the replacement warning, there is an increased possibility that the lamp may break.
	Flashing red	The lamp may be burnt out. First make sure the lamp cover is securely installed. If that's not the problem, let the lamp cool, remove the lamp, and replace it as described on page 97. If this does not resolve the problem, contact Epson as described on page 112.
	Flashing red	Power is cut off because of an internal problem. Unplug the power cord and contact Epson for help, as described on page 112.

Viewing Lamp Usage and Other Information

Use the Info menu to view information about the display settings of your computer and the number of hours the lamp has been used.

Press the **Menu** button and highlight the Info menu.

You see the lamp usage hours and various input signal settings on the right.

The life span of the lamp is about 2000 hours if the **Brightness Control** setting in the Setting menu is set to **High** (default), and 3000 hours if the **Brightness Control** setting is set to **Low**. Make sure you have a spare lamp handy if the usage hours on this menu are close to the life span of your lamp.

note

The information displayed depends on the input signal currently selected.

Solving Problems with the Image or Sound

No image appears on the screen.

- Check that the **Power** light is green, not flashing, and the lens cap is off.
- The projector may be in sleep mode. If the **Power** light is orange, press the **Power** button to turn the projector on.
- If the power was switched off and then on again, the projector may be cooling down. Wait until the **Power** light stops flashing and remains orange; then press the **Power** button again.
- Press the **A/V Mute** button to make sure the picture has not been turned off temporarily.
- The attached computer may be in sleep mode or displaying a black screen saver. Try pressing a key on the computer.

You've connected a computer and see a blue screen with the message No Signal displayed.

- Make sure the cables are connected correctly, as described on page 46.

- Try restarting your computer.
- If you've connected a computer and one or more video sources, you may need to press one of the **Source** buttons on the projector or remote control to select the correct source. Allow a few seconds for the projector to sync up after pressing the button.

If you're using a PC notebook:

- Hold down the **Fn** key on the keyboard and press the function key that lets you display on an external monitor. It may have an icon such as , or it may be labelled **CRT/LCD**. Allow a few seconds for the projector to sync up after pressing it. Check your notebook's manual or online help for details.

On most systems, the  key lets you toggle between the LCD screen and the projector, or display on both at the same time.

- Depending on your computer's video card, you might need to use the Display utility in the Control Panel to make sure that both the LCD screen and external monitor port are enabled. See your computer's documentation or online help for details.

If you're using Macintosh OS X:

1. Open **System Preferences**.
2. Click **Displays**.
3. Make sure the **VGA Display** or **Color LCD** dialog box is selected.
4. Click the **Arrangement** or **Arrange** tab.
5. Make sure the **Mirror Displays** checkbox is selected.

If you're using Macintosh OS 8.6 to 9.x:

1. From the Apple menu, select **Control Panels**, then click **Monitors and Sound**.
2. Click the **Arrange** icon.
3. Drag one monitor icon on top of the other. This lets you display on the projector screen as well as the LCD screen.
4. If this option isn't available, click the **Monitor** icon.

5. Select one of the listed **Simulscan** resolutions. (Allow a few seconds for the projector to sync up after making the selection.)

The message Not Supported is displayed.

- Make sure the correct input signal is selected in the Signal menu (see page 63).
- Make sure your computer's resolution doesn't exceed UXGA (1600 × 1200) and the frequency is supported by the projector (see page 119). If necessary, change your computer's resolution setting as described below.

Only part of the computer image is displayed.

- Press the **Auto** button on the remote control.
- Make sure the image **Position** setting is correct on the Signal menu. See Chapter 6 for more information.
- Make sure your computer's resolution setting is correct. Ideally, it should be 1024 × 768 to match the projector's native resolution. If this option isn't available, select one of the other compatible video formats listed on page 119.
 - **Windows:**
Right-click the desktop, select **Properties**, click the **Settings** tab, and select a different resolution.
 - **Macintosh OS X:**
Open **System Preferences**, click **Displays**, and select a different resolution.
 - **Macintosh OS 8.6 to 9.x:**
On the Apple menu, choose **Control Panels**, and click **Monitors and Sound**. Select a different resolution.
- You also may need to modify existing presentation files if you created them for a different resolution. See your software documentation for specific information.

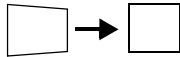
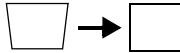

The image isn't square, but keystone-shaped.

- If the top or bottom of the image is broader, press the **Sync +** or **Sync -** button on the projector until the image is square.
- If the projector is angled toward the screen from the left or right, the image will be broader on one side. Center the projector in front of the middle of the screen, facing the screen squarely. If this doesn't work, press the **Tracking +** or **Tracking -** button on the projection until the image is square.
- If the image has no parallel sides, use **Quick Corner**. Press the **Menu** button, select the **Setting** menu, and select **Keystone**. Select **Quick Corner** and make your adjustments with the  pointer button. See page 36 for details.

The image contains static or noise.

- Make sure the correct input signal is selected in the **Signal** menu (see Chapter 6).
- If you're using a computer cable longer than 6 feet, or an extension cable, the image quality may be reduced.
- Keep your computer and video cables away from the power cord as much as possible to prevent interference.
- The video signal may be split between the computer and the projector. If you notice a decline in the projected image quality when the image is displayed simultaneously on your notebook computer and the projector, turn off the notebook's LCD display.

The image is blurry.

- There may be dirt or smears on the lens. Clean the lens as described on page 95.
- Adjust the focus using the focus buttons (see page 25).
- Make sure the lens is not fogged by condensation. You may need to wait before using the projector after moving it from a cold environment to a warm environment.

- Adjust the **Sharpness** setting on the Image menu (see page 62). When you change video settings, you should be able to see the effect on the screen immediately. If you're projecting from a computer, you may also need to adjust the tracking and sync as described in the next section. If you don't like the new settings, you can always select **Reset** to return to the factory default settings.

You see vertical bands or the image still looks blurry after trying the solutions in the previous section.

- If you're projecting from a computer and displaying an image that contains a lot of fine detail, you may notice vertical bands or some of the characters may look heavy or blurred. Press the **Auto** button on the remote control to reset the projector's tracking and sync settings.
- If further adjustment is needed, you can fine-tune the **Tracking** and **Sync** settings manually using the buttons on the projector.
 1. Fill the screen with an image containing fine detail, such as pattern to appear as your desktop background, or try projecting black text on a white background.
 2. Adjust the **Tracking** to eliminate vertical bands.

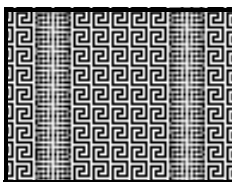

3. Adjust the **Sync** setting to increase the image sharpness.

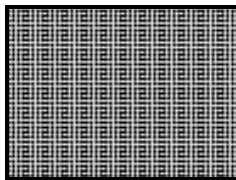



note

Because of the different technologies used, your projected image may not exactly match the colors on your notebook or computer monitor.

The image colors are incorrect.

- If you're displaying a computer image, use the **Color Mode** option in the projector's Image menu to adjust the color. If you're displaying video, adjust the **Color Adjustment** and **Color Mode** settings on the Image menu.
- Check your computer display settings to correct the color balance.

There is no sound.

- Make sure A/V Mute is not enabled. (The **A/V Mute** button may have been pressed.)
- Try adjusting the **Volume** setting in the Setting menu (see page 67).
- If you're using a VCR or other video source, make sure the volume is not turned all the way down or muted. Also, make sure the cables are connected correctly, as described in on page 56.
- If your presentation includes computer audio, make sure the volume control on your computer is not turned all the way down or muted. If you're using the audio cable, make sure it is securely connected to both the projector and your computer's  headphone jack or  audio out jack.
- Make sure the Windows volume controls on your computer are not turned all the way down or set to Mute. You may be able to check this by clicking the volume control in your Windows system tray (lower right corner of the screen).

Solving Easy Management Problems

You don't see your projector in the EMP Monitor window.

- Make sure that you've connected the projector to the network and configured it correctly; see page 80. Also, make sure you've registered the projector with EMP Monitor; see page 81.
- Make sure that Standby Mode in the projector's Extended menu is set to **Network ON**.
- If the computer you are using is running Windows XP or 2000, you must be logged in as the Administrator.
- Try restarting your computer.

Solving Problems with the Remote Control

The projector doesn't respond to remote control commands.

- Be sure the ON/OFF switch is in the **ON** position, as shown on page 19.
- The remote control's batteries may not be installed correctly or may be low on power. To change the batteries, see page 33.
- Make sure your remote control's ID is set to 0 or to the projector's ID; see page 73.
- Make sure you are within about 33 feet (10 meters) of the projector and within range of the projector's front or back sensor (approximately 20° to the left or right and 40° above or below).
- Dim the room lights and turn off any fluorescent lights. Make sure the projector is not in direct sunlight. Strong lighting, especially fluorescent lights, may affect the projector's infrared receivers. Also, turn off any nearby equipment that emits infrared energy, such as a radiant room heater.

Where To Get Help

Epson provides technical assistance through electronic support services 24 hours a day, as listed in the following table.

Service	Access
World Wide Web	From the Internet, you can reach Epson's product support page at http://support.epson.com . After selecting your product, you can access troubleshooting information, download product documentation, and receive technical advice through e-mail.
Presenters Online	Access tips, templates, and training for developing successful presentations at http://www.presentersonline.com

Telephone Support Services

To use the Epson PrivateLine Support service, call (800) 637-7661 and enter the PIN on the Epson PrivateLine Support card included in your *Start Here* kit. This is the fastest way of speaking to a live representative, and it's free. This service is available 6 AM to 6 PM, Pacific Time, Monday through Friday, for the duration of your warranty period.

You may also speak with a projector support specialist by dialing one of these numbers:

- U.S.: (562) 276-4394, 6 AM to 6 PM, Pacific Time, Monday through Friday
- Canada: (905) 709-3839, 6 AM to 6 PM, Pacific Time, Monday through Friday

Toll or long distance charges may apply.

Before you call, please have the following information ready:

- Product name (Epson PowerLite 830p)
- Product serial number (located on the bottom of the projector)
- Computer configuration
- Description of the problem

You can purchase screens, carrying cases, or other accessories from Epson at (800) 873-7766 or by visiting the Epson Store at www.epsonstore.com (U.S. sales only). In Canada, please call (800) 463-7766 for dealer referral.

A *Software Installation*

The Epson Projector Software CD-ROM includes EMP Monitor and EMP Network Manager for presenting and monitoring the projector from a remote location.

Windows System Requirements

Before you install the software, make sure your computer meets these requirements:

- Microsoft Windows 98, 2000, Me, or XP
- IBM® compatible PC with at least a Pentium® III 700 MHz processor
- At least 256MB of RAM
- At least 128MB of free hard disk space
- SVGA (800 × 600) or better display adapter and monitor

Installing the Software on a Windows System

Follow these steps:

1. Insert the Epson Projector software CD-ROM in your computer's CD-ROM or DVD drive. You see this screen:



2. Click **Install**, then follow the on-screen instructions to install your projector software.

When you see a message that the Epson GDI Monitor Driver has not passed Windows Logo testing, click **Continue Anyway**.

3. When installation is complete, close the installation window.

B *Projector Installation*

This appendix provides guidelines on installing the projector in a permanent location, such as a theater or conference room.

The projector can be installed for four different viewing setups: front projection, ceiling mounting, rear projection onto a semi-transparent screen, or rear/ceiling projection, as shown:

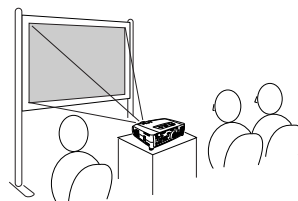

Front projection

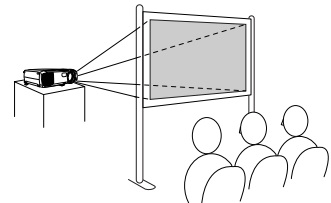

Rear projection

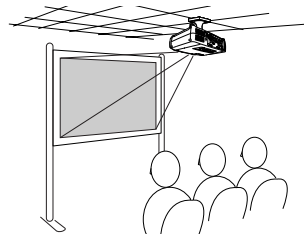

Ceiling mounting

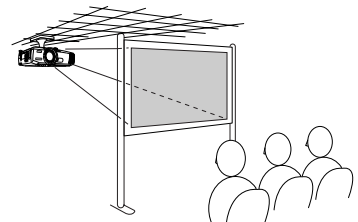

Rear/ceiling projection

To project from overhead, you'll need the optional ceiling mounting hardware; see page 13 for ordering information. You'll also need to select **Front/Ceiling** or **Rear/Ceiling** as the Projection option of the projector's Extended menu to flip the image upside-down. To project from the rear, onto a semi-transparent screen, select **Rear** or **Rear/Ceiling** (see page 75).

If you're mounting the projector on the ceiling and you place it above screen level, you'll have to tilt the projector down to position the image on the screen. This causes the image to lose its square shape.

You can correct the distortion using the **Keystone** function in the projector's menu system (see page 65) or the keystone buttons on the projector's control panel.

If you place the projector so that the base of the lens is level with the bottom of the screen, the image should be square and you won't have to adjust it. If you place the lens lower than the bottom of the screen, you'll have to tilt the projector upward if you want to fill the whole screen with the image.

C *Technical Specifications*

General

Type of display	Poly-silicon TFT active matrix
Size of LCD panels	Diagonal: 0.8 inches (20.3 mm)
Resolution (native format)	1024 × 768 pixels (XGA)
Color reproduction	24 bit, 16.8 million colors
Brightness	3000 lumens (High Brightness mode) 2200 lumens (Low Brightness mode)
Contrast ratio	600:1
Image size	30 to 300 inches
Projection distance	2.8 to 48.3 feet (0.9 to 14.7 meters)
Projection methods	Front, rear, upside-down (ceiling mount)
Internal sound system	5 W monaural
Optical aspect ratio	4:3 (horizontal:vertical)
Zoom ratio	1:1.6
Noise level	28 dB or 34 dB (depends on the Brightness Control setting in the Setting menu)
Keystone correction	Automatic (vertical and horizontal); manual adjustment capability $\pm 45^\circ$ (vertical) and $\pm 25^\circ$ (horizontal)
Mouse compatibility	Supports USB

Projection Lamp

Type	UHE (Ultra High Efficiency)
Power consumption	200 W
Lamp life	Approx. 2000 hours (High Brightness mode) Approx. 3000 hours (Low Brightness mode)
Part number	V13H010L31

Remote Control

Range	33 feet (10 meters)
Batteries (2)	Alkaline AA

Dimensions

Height	4.5 inches (114 mm), feet retracted
Width	14.4 inches (365 mm)
Depth	11.0 inches (280 mm)
Weight	10.4 lb (4.7 kg)

Electrical

Rated frequency	50/60 Hz AC
Power supply	100 to 120 VAC, 3.6 A 200 to 240 VAC, 1.6 A
Power consumption	Operating: 310 W

Environmental

Temperature	Operating: 41 to 95 °F (5 to 35 °C) Storage: 14 to 140 °F (-10 to 60 °C)
Humidity (non-condensing)	Operating: 20 to 80% RH Storage: 10 to 90% RH

Safety

United States	FCC 47CFR Part 15B Class B (DoC) UL60950 Third Edition
Canada	ICES-003 Class B CSA C22.2 No. 60950 (cUL)
CE Marking	Directive 73/23/EEC Directive 89/336/EEC IEC 60950 Third Edition EN 55022, EN 55024



Pixelworks™ DNX™ ICs are used in this projector.

Compatible Video Formats

The projector supports NTSC, PAL, and SECAM international video standards, as well as the monitor display formats listed below.

To project images output from a computer, the computer's video card must be set at a refresh rate (vertical frequency) that's compatible with the projector. Some images are automatically resized to display in the projector's "native" format (XGA). The frequencies of some computers may not allow images to display correctly; see your computer's documentation for details.

Mode	Refresh Rate (Hz)	Resolution
VGA EGA	70	640 × 350*
VGA—60	60	640 × 480*
VESA—72	72	640 × 480*
VESA—75	75	640 × 480*
VESA—85	85	640 × 480*
SVGA—56	56	800 × 600*
SVGA—60	60	800 × 600*
SVGA—72	72	800 × 600*
SVGA—75	75	800 × 600*
SVGA—85	85	800 × 600*
SVGA—120	120	800 × 600*

Mode	Refresh Rate (Hz)	Resolution
XGA—60	60	1024 × 768
XGA—70	70	1024 × 768
XGA—75	75	1024 × 768
XGA—85	85	1024 × 768
XGA—100	100	1024 × 768
XGA—120	120	1024 × 768
SXGA1—70	70	1152 × 864*
SXGA1—75	75	1152 × 864*
SXGA1—85	85	1152 × 864*
SXGA1—100	100	1152 × 864*
SXGA2—60	60	1280 × 960*
SXGA2—75	75	1280 × 960*
SXGA2—85	85	1280 × 960*
SXGA3—60	60	1280 × 1024*
SXGA3—75	75	1280 × 1024*
SXGA3—85	85	1280 × 1024*
UXGA—60	60	1600 × 1200*
UXGA—65	65	1600 × 1200*
UXGA—70	70	1600 × 1200*
UXGA—75	75	1600 × 1200*
UXGA—80	80	1600 × 1200*
UXGA—85	85	1600 × 1200*
MAC13	67	640 × 480*
MAC16	75	832 × 624*
MAC19	75	1024 × 768
MAC21	75	1152 × 870*
NTSC	60	—
NTSC 4:43	60	—
PAL	50	—
N-PAL	50	—
M-PAL	60	—
PAL—60	60	—
SECAM	50	—
HDTV (720p)	60	1024 × 576*
HDTV (1080i)	60	1024 × 576*
SDTV (480i)	60	1024 × 768
SDTV (480p)	60	1024 × 768
SDTV (625i)	50	1024 × 768
SDTV (625p)	50	1024 × 768

*The image is resized using Epson's SizeWise™ Technology.

D

Notices

This appendix includes safety instructions and other important information about your Epson PowerLite projector.

Important Safety Instructions

Follow these safety instructions when setting up and using the projector:

- Do not place the projector on an unstable cart, stand, or table.
- Do not use the projector near water or sources of heat.
- Use the type of power source indicated on the projector. If you are not sure of the power available, consult your dealer or power company.
- Place the projector near a wall outlet where the plug can be easily unplugged.

Placez l'appareil près d'une prise de courant où la fiche peut être débranchée facilement.

- Insert the projector's three-wire grounding-type plug into a properly grounded outlet. If you have a two-prong outlet, contact an electrician to replace it. Do not hold the plug with wet hands.
- Take the following precautions for the plug. Failure to comply with these precautions could result in sparks or fire: Do not insert the plug into an outlet with dust present. Insert the plug firmly into the outlet.
- Do not overload wall outlets, extension cords, or integral convenience receptacles. This can cause fire or electric shock.
- Do not place the projector where the cord can be walked on. This may result in fraying or damage to the plug.
- Unplug the projector from the wall outlet before cleaning. Use a damp cloth for cleaning. Do not use liquid or aerosol cleaners.
- Do not block the slots and openings in the projector case. They provide ventilation and prevent the projector from overheating. Do not operate the projector on a sofa, rug, or other soft surface, or in a closed-in cabinet unless proper ventilation is provided.

- Never push objects of any kind through the cabinet slots. Never spill liquid of any kind into the projector.
- Except as specifically explained in this *User's Guide*, do not attempt to service this product yourself. Refer all servicing to qualified personnel. Opening or removing covers may expose you to dangerous voltages and other hazards.
- Unplug the projector from the wall outlet and refer servicing to qualified service personnel under the following conditions: When the power cord or plug is damaged or frayed. If liquid has been spilled into the projector, or if it has been exposed to rain or water. If it does not operate normally when you follow the operating instructions, or if it exhibits a distinct change in performance, indicating a need for service. If it has been dropped or the housing has been damaged.
- This product includes a lamp component that contains mercury (Hg). Please consult your state and local regulations regarding proper disposal and do not put in the trash.
- Unplug the projector during lightning storms or when it will not be used for extended periods.
- Do not place the projector and/or remote control on top of heat-producing equipment or in a hot location.
- If you use the projector in a country other than where you purchased it, use the correct power cord for that country.
- Do not stand on the projector or place heavy objects on it.
- Do not use the projector outside of the required temperature range of 41 to 95 °F (5 to 35 °C). Doing so may cause an unstable display and could lead to projector damage.
- Do not store the projector outside of the required temperature range of 14 to 140 °F (-10 to 60 °C) or in direct sunlight for long periods of time. Doing so may cause damage to the case.

WARNING: This product contains chemicals, including lead, known to the State of California to cause birth defects or other reproductive harm.

Wash hands after handling.

Remote Control Information

You can operate the projector by remote control via a line-of-sight infrared (IR) receiver at the front and rear of the projector. The projector may not respond to remote control commands under the following conditions:

- There is an object between the remote control IR emitter and the IR receiver on the projector.
- Ambient light is too bright.
- Certain types of fluorescent lighting are used.
- A strong light source shines into the IR receiver.
- Other equipment that emits infrared energy, such as a radiant room heater, is in the room.

These conditions commonly cause problems for most infrared-controlled equipment. Try the following:

- The remote control's batteries may be low on power; replace them.
- Dim the ambient lighting and/or turn off any fluorescent lights.
- Close any window coverings and/or move the projector out of direct sunlight.
- Turn off other equipment that emits infrared energy.

Declaration of Conformity

According to 47CFR, Part 2 and 15, Class B Personal Computers and Peripherals; and/or CPU Boards and Power Supplies used with Class B Personal Computers

We: Epson America, Inc.
Located at: 3840 Kilroy Airport Way
MS: 3-13
Long Beach, CA 90806-2469

Telephone: (562) 290-5254

Declare under sole responsibility that the product identified herein, complies with 47CFR Part 2 and 15 of the FCC rules as a Class B digital device. Each product marketed, is identical to the representative unit tested and found to be compliant with the standards. Records maintained continue to reflect the equipment being produced can be expected to be within the variation accepted, due to quantity production and testing on a statistical basis as required by 47CFR §2.909. Operation is subject to the following two conditions: (1) this device may not cause harmful interference, and (2) this device must accept any interference received, including interference that may cause undesired operation.

Trade Name: Epson
Type of Product: Projector
Model: EMP-830
Marketing Name: PowerLite 830p

FCC Compliance Statement

For United States Users

This equipment has been tested and found to comply with the limits for a Class B digital device, pursuant to Part 15 of the FCC Rules. These limits are designed to provide reasonable protection against harmful interference in a residential installation. This equipment generates, uses, and can radiate radio frequency energy and, if not installed and used in accordance with the instructions, may cause harmful interference to radio or television reception. However, there is no guarantee that interference will not occur in a particular installation. If this equipment does cause interference to radio and television reception, which can be determined by turning the equipment off and on, the user is encouraged to try to correct the interference by one or more of the following measures:

- Reorient or relocate the receiving antenna.
- Increase the separation between the equipment and receiver.
- Connect the equipment into an outlet on a circuit different from that to which the receiver is connected.
- Consult the dealer or an experienced radio/TV technician for help.

WARNING

The connection of a non-shielded equipment interface cable to this equipment will invalidate the FCC Certification of this device and may cause interference levels which exceed the limits established by the FCC for this equipment. It is the responsibility of the user to obtain and use a shielded equipment interface cable with this device. If this equipment has more than one interface connector, do not leave cables connected to unused interfaces. Changes or modifications not expressly approved by the manufacturer could void the user's authority to operate the equipment.

For Canadian Users

This Class B digital apparatus meets all requirements of the Canadian Interference-Causing Equipment Regulations.

Cet appareil numérique de la classe B respecte toutes les exigences du Règlement sur le matériel brouilleur du Canada.

Warranty

Epson America, Inc. Limited Warranty

Basic Two-Year Warranty and 90-Day Lamp Warranty

What Is Covered: Epson America, Inc. (“Epson”) warrants to the original retail purchaser of the Epson product enclosed with this limited warranty statement that the product, if purchased new and operated in the United States or Canada, conforms to the manufacturer’s specifications and will be free from defects in workmanship and materials for a period of two (2) years from the date of original purchase (except that the warranty period is 90 days for projector lamps). For warranty service, you must provide proof of the date of original purchase.

What Epson Will Do To Correct Problems: If you elect carry-in warranty service, please bring the product securely packaged in its original container or an equivalent, along with proof of the date of original purchase, to your Epson Dealer or Epson Customer Care Center. Epson will, at its option, repair or replace on an exchange basis the defective unit, without charge for parts or labor. When warranty service involves the exchange of the product or of a part, the item replaced becomes Epson property. The exchanged product or part may be new or previously refurbished to the Epson standard of quality, and at Epson’s option, the replacement may be another model of like kind and quality. Epson’s liability for replacement of the covered product will not exceed the original retail selling price of the covered product. Exchange or replacement products or parts assume the remaining warranty period of the product covered by this limited warranty. However, each replacement lamp carries the limited 90-day warranty stated above.

What This Warranty Does Not Cover: This warranty does not apply to refurbished or reconditioned products. This warranty covers only normal consumer use in the United States and Canada. 24-hour-per-day use causes unusual strain and is not considered normal use. This warranty does not cover consumables (e.g., fuses), other than lamps. This warranty is not transferable. Epson is not responsible for warranty service should the Epson label or logo or the rating label or serial number be removed or should the product fail to be properly maintained or fail to function properly as a result of misuse, abuse, improper installation, neglect, improper shipping, damage caused by disasters such as fire, flood, and lightning, improper electrical current, software problems, interaction with non-Epson products, or service other than by an Epson Authorized Servicer. Postage, insurance, or shipping costs incurred in presenting your Epson product for carry-in warranty service are your responsibility. If a claimed defect cannot be identified or reproduced in service, you will be held responsible for costs incurred.

THE WARRANTY AND REMEDY PROVIDED ABOVE ARE EXCLUSIVE AND IN LIEU OF ALL OTHER EXPRESS OR IMPLIED WARRANTIES INCLUDING, BUT NOT LIMITED TO, THE IMPLIED WARRANTIES OF MERCHANTABILITY OR FITNESS FOR A PARTICULAR PURPOSE. SOME LAWS DO NOT ALLOW THE EXCLUSION OF IMPLIED WARRANTIES. IF THESE LAWS APPLY, THEN ALL EXPRESS AND IMPLIED WARRANTIES ARE LIMITED TO THE WARRANTY PERIOD IDENTIFIED ABOVE. UNLESS STATED HEREIN, ANY STATEMENTS OR REPRESENTATIONS MADE BY ANY OTHER PERSON OR FIRM ARE VOID. IN THE EVENT THE REMEDIES ABOVE FAIL, EPSON'S ENTIRE LIABILITY SHALL BE LIMITED TO A REFUND OF THE PRICE PAID FOR THE EPSON PRODUCT COVERED BY THIS LIMITED WARRANTY. EXCEPT AS PROVIDED IN THIS WRITTEN WARRANTY, NEITHER EPSON AMERICA, INC. NOR ITS AFFILIATES SHALL BE LIABLE FOR ANY LOSS, INCONVENIENCE, OR DAMAGE, INCLUDING DIRECT, SPECIAL, INCIDENTAL, OR CONSEQUENTIAL DAMAGES, RESULTING FROM THE USE OR INABILITY TO USE THE EPSON PRODUCT, WHETHER RESULTING FROM BREACH OF WARRANTY OR ANY OTHER LEGAL THEORY.

In Canada, warranties include both warranties and conditions.

Some jurisdictions do not allow limitations on how long an implied warranty lasts and some jurisdictions do not allow the exclusion or limitation of incidental or consequential damages, so the above limitations and exclusions may not apply to you. This warranty gives you specific legal rights, and you may also have other rights, which vary from jurisdiction to jurisdiction.

To locate the Authorized Epson Servicer nearest you, call the Epson ConnectionSM at (800) 637-7661 + PIN or (562) 276-4394 in the U.S. and (905) 709-3839 in Canada or write to: Epson America, Inc., P.O. Box 93012, Long Beach, CA 90809-3012.

Index

A

- A/V Mute, 37, 72, 105
- About menu, 99 to 100, 105
- Accessories, 13, 112
- Adapter, Macintosh, 13, 48
- Air filter
 - cleaning, 96 to 97
 - ordering, 13
 - replacing, 97 to 98
- Anti-theft device, 13, 17
- Aspect ratio, 117
- Audio
 - adjusting volume, 67
 - connecting equipment, 56 to 57
 - problems, troubleshooting, 110
 - turning off (using A/V Mute), 37
- Auto button, 28
- Auto Setup setting, 64

B

- Background Color setting, 69
- Bands, vertical, 109
- Batteries, installing, 33
- Blackboard, projecting on, 40 to 41
- Blank screen, 21 to 23
- Blurry image, 108 to 109
- Brightness, 117
- Brightness setting, 63

C

- Cables
 - included with projector, 12
 - mouse, 49
 - ordering, 13
 - remote control cable set, 13
 - S-video, 13, 53
 - VGA-to-component, 47
- Capturing image, 71 to 72
- Carrying case, 13, 100

- Ceiling mount, 13, 115 to 116
- Cleaning
 - air filter, 96 to 97
 - lens, 95
 - projector case, 96
- Color
 - correcting with Wall Shot, 40 to 41
 - problems, 110
 - settings, 66
- Color Mode setting, 62, 66
- Component video cable, 13, 51
- Composite (RCA) video cable, 51 to 52
- Computer
 - connecting to, 46 to 48
 - correcting images, 28
 - selecting source, 20
- Connecting projector
 - to a computer, 46 to 48
 - to an external monitor, 50
 - to audio equipment, 56 to 57
 - to video equipment, 51 to 55
- Contrast setting, 63

D

- Declaration of Conformity, 124
- Default settings, restoring, 61
- Desktop adapter, Macintosh, 13, 48
- Direct Power On, 30
- Distance from projector to screen, 16, 117
- Documentation, 10
- DVD player, connecting, 51 to 55

E

- EasyManagement
 - configuring the projector, 80 to 81
 - installing software, 113 to 114
 - monitoring the projector, 81 to 88
 - problems, 111
 - receiving e-mail alerts, 89 to 92
- Electrical specifications, 118

EMP Monitor
installing software, 114
problems, 111
using, 81 to 88
EMP NetworkManager, using, 89 to 93
Environmental specifications, 118
Epson
accessories, 13, 112
presentation tips, 10
PrivateLine Support, 11, 112
technical support, 10, 112
E-Zoom button, 38

F

FCC compliance statement, 125
Filter, *see* Air filter
Focusing image, 25
Freeze button, 37

G

Group, saving menu settings as, 64

H

HDTV images, video formats, 120
Height of image, adjusting, 24
Help system, using, 102
Help, Epson, 10, 112
HP OpenView, 79

I

ID setting, 73 to 74

Image
adjusting, 24 to 28, 62 to 66
blurry, 108 to 109
capturing and saving in projector, 71 to 72
correcting shape, 26 to 27, 36, 65, 108
fitting on screen, 64, 107
height, adjusting, 24
problems with, 105 to 110
projecting on walls, 40 to 41
raising, 24
selecting source, 20, 34 to 35, 52, 53, 55
size and projection distance, 16, 117
turning off (using A/V Mute), 37
zooming, 25, 38

Image menu, 62 to 65

Input signal, selecting, 20, 34 to 35, 52, 53, 55

Installing projector, 115 to 116

Installing software, 113 to 114

K

Kensington anti-theft device, 13, 17

Keystone correction, 26 to 27, 65, 108, 117

L

Lamp

number of hours used, 105

ordering, 13

replacing, 97 to 100

specifications, 118

status light, 103 to 104

Lamp timer, resetting, 99 to 100

Language setting, 75, 102

Laptop computer

connecting to, 47

display problems, 21 to 23, 105 to 107

selecting source, 20, 47

Lens, cleaning, 95

Lights, status, 103 to 104

Living Room color mode, 62, 66

Logo, saving on projector, 71 to 72

M

Macintosh desktop adapter, 13, 48

Manuals, 10

Menus

- About, 99 to 100, 105
- changing settings, 60 to 61
- default settings, restoring, 61
- Image, 62 to 65
- Signal, 63 to 65
- User's Logo, 71 to 72

Monitor, connecting external, 50

Monitoring projector

- EMP Monitor, 81 to 88
- HP OpenView, 79
- receiving e-mail alerts, 89 to 93
- remote setup options, 75

Mouse,

- compatibility, 117
- connecting cable for remote, 49
- using remote control as, 41

N

Network

- managing projector remotely, 79 to 93
- setting, 85, 87, 91

Network settings, configuring, 80 to 81

New Hardware Wizard, 19

No Signal message, 21, 105 to 107

Noise level, 117

Numeric keypad, using, 69

O

Operation Lock setting, 72

Optical aspect ratio, 117

Options for projector, 13

P

Password

- request code, 70

Password protection, 68 to 70

Picture source, selecting, 20, 34 to 35, 52, 53, 55

Picture, *see* Image

P-in-P image, 38 to 39

Pointer tool, using, 43 to 44

Positioning

- image, 24
- projector, 16 to 17

Power

- button, 19
- specifications, 118
- light, 19, 103 to 104

Presentation color mode, 62, 66

Presentations

- computer, 20, 28, 46 to 49
- room conditions, 32
- tips and training, 10
- using the pointer tool, 43 to 44
- video, 20, 51 to 55

Presenters Online, 10, 112

Preset setting, 64

PrivateLine Support, 11, 112

Problems

- color, 110
- image, 105 to 110
- monitoring projector, 111
- no signal, 21, 105 to 107
- remote control, 111
- sound, 110
- using on-screen help, 102

Projecting without screen, 40 to 41

Projection lamp, *see* Lamp

Projector

- carrying case, 13, 100
- cleaning, 95
- connections, *see* Connecting projector
- disabling buttons, 72
- distance from screen, 16, 117
- ID, setting, 73
- installing, 115 to 116
- lamp specifications, 118
- monitoring remotely, 75, 79 to 93
- multiple projectors, controlling, 73 to 74
- options, 13
- password protection, 68 to 70
- positioning, 16 to 17
- resolution, 117
- specifications, 117 to 119
- transporting, 100
- troubleshooting, 101 to 104
- turning off, 29
- turning on, 18 to 19
- unpacking, 12
- viewing information about, 105

Q

Quick Corner, 36
Quick Setup, 76 to 77

R

Raising image, 24
Rear-screen projection, 75, 115 to 116
Registration, 11

Remote control

- A/V Mute button, 37
- as wireless mouse, 41
- battery used, 118
- checking ID, 74
- connecting cable for mouse, 49
- correcting color, 40 to 41
- E-Zoom button, 38
- Freeze button, 37
- information, 123
- numeric keypad, using, 69
- pointer tool, using, 43 to 44
- problems, 111, 123
- range, 118
- replacing batteries, 33
- setting ID, 74
- specifications, 118
- storing, 32
- switching sources, 34 to 35
- troubleshooting, 111
- turning on, 19, 32

Replacing lamp, 97 to 100
Request code, password, 70
Resetting lamp timer, 99 to 100
Resetting menu options, 61
Resize image, 65
Resolution, 64, 117

S

Safety

- instructions, 121 to 122
- specifications, 119

Screen

- blank, 21 to 23
- distance from projector, 16
- ordering, 13
- startup screen, creating, 71 to 72

Screen image, *see* Image

Security

- Kensington lock, 13
- password protection, 68 to 70

Sharpness setting, 63
Signal menu, 63 to 65
Sleep mode, 29

SNMP, 79, 80
Software installation, 113 to 114
Sound
 adjusting, 67
 troubleshooting, 110
Source
 selecting, 20, 34 to 35
 viewing, 105
Speaker, specifications, 117
Speakers, connecting, 57
Specifications
 brightness, 117
 dimensions, 118
 electrical, 118
 environmental, 118
 general, 117
 lamp, 118
 remote control, 118
 resolution, 117
 safety, 119
sRGB color mode, 63, 66
Standby Mode setting, 75, 85, 87, 91
Startup screen
 user's logo, *See* User's Logo
Startup screen, creating, 71 to 72
Status lights, 103 to 104
Support, *see* Technical support
S-video cable, 13
Switching picture source, 20, 34 to 35
Sync setting, 64
Synchronization, adjusting, 28, 109

T

Technical support, 10, 112
Temperature
 requirements, 118
 status light, 103 to 104
Theatre color mode, 62, 66
Tone, adjusting, 67
Tracking, adjusting, 28, 109
Transporting projector, 100

Troubleshooting
 blank screen, 21 to 23, 105 to 106
 cut-off image, 107
 distorted image, 26 to 27
 EasyManagement, 111
 image and sound problems, 105 to 110
 no signal, 21, 105 to 107
 projector problems, 101 to 104
 remote control problems, 111
Turning off picture (using A/V Mute), 37
Turning off projector, 29

U

Unpacking projector, 12
USB cable, 12, 49
User's Logo menu, 71 to 72

V

VCR, connecting, 51 to 55
Video
 cables, 12, 13, 51
 connecting video equipment, 51 to 55
 display settings, viewing, 105
 formats, supported, 119 to 120
 selecting source, 20, 34 to 35, 52, 53
Video Signal setting, 65
Volume, adjusting, 67

W

Wall Shot, 40 to 41
Warning lights, 103 to 104
Warranty, 11, 126
Wireless, mouse, 41, 49

Z

Zoom ratio, 117
Zooming image, 25, 38

Front/Top

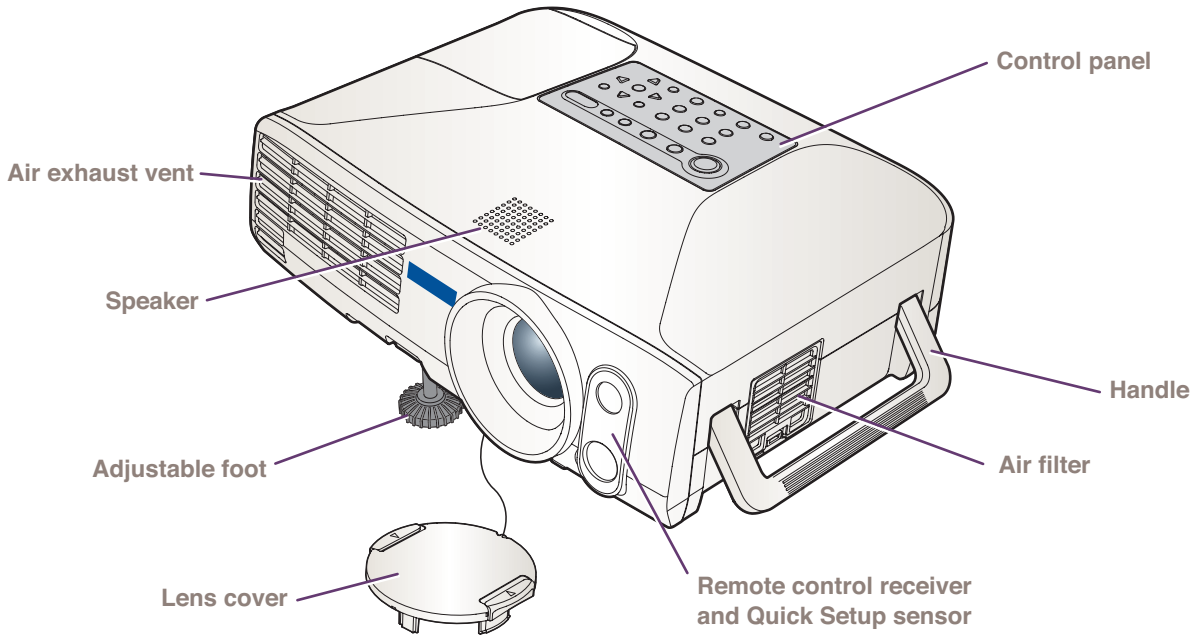

Back

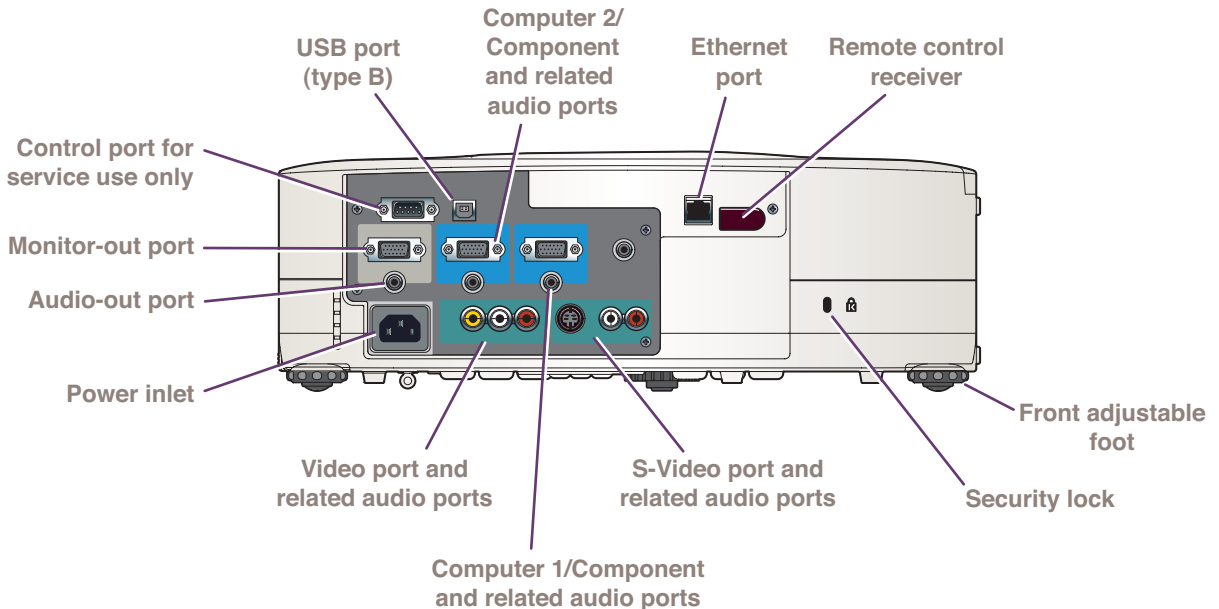

Remote Control

