

# Panasonic®

LCD Projector

## Operating Instructions

Model No. **PT-AE900E**

ENGLISH

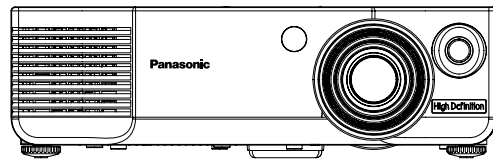

Before operating this product, please read the instructions carefully and save this manual for future use.

# Dear Panasonic Customer:

This instruction booklet provides all the necessary operating information that you might require. We hope it will help you to get the most out of your new product, and that you will be pleased with your Panasonic LCD projector. The serial number of your product may be found on its bottom. You should note it in the space provided below and retain this booklet in case service is required.

Model number: **PT-AE900E**

Serial number: \_\_\_\_\_

## IMPORTANT SAFETY NOTICE

**WARNING:** THIS APPARATUS MUST BE EARTHED.

**WARNING:** To prevent damage which may result in fire or shock hazard, do not expose this appliance to rain or moisture.

Machine Noise Information Ordinance 3. GSGV, January 18, 1991: The sound pressure level at the operator position is equal or less than 70 dB (A) according to ISO 7779.

**WARNING:**

- 1) Remove the plug from the mains socket when this unit is not in use for a prolonged period of time.
- 2) To prevent electric shock, do not remove cover. No user serviceable parts inside. Refer servicing to qualified service personnel.
- 3) Do not remove the earthing pin on the mains plug. This apparatus is equipped with a three prong earthing-type mains plug. This plug will only fit an earthing-type mains socket. This is a safety feature. If you are unable to insert the plug into the mains socket, contact an electrician. Do not defeat the purpose of the earthing plug.

**CAUTION:**

To assure continued compliance, follow the attached installation instructions, which includes using the provided power cord and shielded interface cables when connecting to computer or peripheral device. If you use serial port to connect PC for external control of projector, you must use optional RS-232C serial interface cable with ferrite core. Any unauthorized changes or modifications to this equipment will void the user's authority to operate.

**IMPORTANT: THE MOULDED PLUG (U.K. only)****FOR YOUR SAFETY, PLEASE READ THE FOLLOWING TEXT CAREFULLY.**

This appliance is supplied with a moulded three pin mains plug for your safety and convenience. A 13 amp fuse is fitted in this plug. Should the fuse need to be replaced, please ensure that the replacement fuse has a rating of 13 amps and that it is approved by ASTA or BSI to BS1362.

Check for the ASTA mark  or the BSI mark  on the body of the fuse.

If the plug contains a removable fuse cover, you must ensure that it is refitted when the fuse is replaced. If you lose the fuse cover, the plug must not be used until a replacement cover is obtained. A replacement fuse cover can be purchased from an Authorised Service Centre.

**If the fitted moulded plug is unsuitable for the mains socket in your home, then the fuse should be removed and the plug cut off and disposed of safely. There is a danger of severe electrical shock if the cut off plug is inserted into any 13 amp socket.**

If a new plug is to be fitted, please observe the wiring code as shown below. If in any doubt, please consult a qualified electrician.

**WARNING: — THIS APPLIANCE MUST BE EARTHED.**

**IMPORTANT:** — The wires in this mains lead are coloured in accordance with the following code: —

Green-and-Yellow:	Earth
Blue:	Neutral
Brown:	Live

As the colours of the wire in the mains lead of this appliance may not correspond with the coloured markings identifying the terminals in your plug, proceed as follows.

The wire which is coloured GREEN-AND-YELLOW must be connected to the terminal in the plug which is marked with the letter E or by the Earth symbol  or coloured GREEN or GREEN-AND-YELLOW.

The wire which is coloured BLUE must be connected to the terminal in the plug which is marked with the letter N or coloured BLACK.

The wire which is coloured BROWN must be connected to the terminal in the plug which is marked with the letter L or coloured RED.

**How to replace the fuse:** Open the fuse compartment with a screwdriver and replace the fuse.

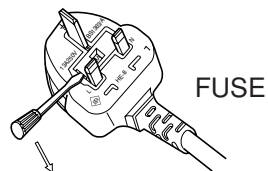

# Contents

**Preparation**

<b>IMPORTANT SAFETY NOTICE ...</b>	<b>2</b>
<b>Precautions with regard to safety .....</b>	<b>6</b>
<b>Accessories .....</b>	<b>10</b>
<b>Before use .....</b>	<b>11</b>
<b>Location and function of each part .....</b>	<b>13</b>

**Getting started**

<b>Setting-up .....</b>	<b>18</b>
Projection methods, Projector position, Projection distances, Setting up range using the lens shift function	
<b>Connections .....</b>	<b>22</b>
Connecting to video equipment, Connecting to equipment compatible with HDMI, Connecting to computer	
<b>Preparation for the remote control unit .....</b>	<b>25</b>

**Basic operation**

<b>Turning on the power .....</b>	<b>26</b>
<b>Turning off the power .....</b>	<b>28</b>

**Useful functions**

<b>Setting the aspect ratio .....</b>	<b>30</b>
<b>Selecting the picture mode .....</b>	<b>33</b>
<b>Turning on the button lights .....</b>	<b>33</b>
<b>Retrieving the saved picture settings .....</b>	<b>34</b>
<b>Turning off the picture momentarily .....</b>	<b>34</b>
<b>Displaying the "PICTURE" menu .....</b>	<b>35</b>
<b>Displaying the "ADVANCED MENU" .....</b>	<b>35</b>
<b>Using the colour management function .....</b>	<b>36</b>

**Adjustments and settings**

<b>On-screen menus .....</b>	<b>40</b>
Menu screens, Menu operation guide, Returning a setting to the factory default	
<b>Adjusting the picture .....</b>	<b>44</b>
PICTURE MODE, CONTRAST, BRIGHT, COLOUR, TINT,	

SHARPNESS, COLOUR TEMP., DYNAMIC IRIS, Noise Reduction(NR), CINEMA REALITY, TV-SYSTEM, ADVANCED MENU, MEMORY SAVE, MEMORY LOAD, SIGNAL MODE, Projecting sRGB-compatible pictures

**Adjusting the position .....** **48**  
Horizontal position, Vertical position, DOT CLOCK, CLOCK PHASE, ASPECT, WSS, OVER SCAN, KEYSTONE, AUTO SETUP

**Changing the display language .....** **50**

**Option settings .....** **51**  
OSD, OSD DESIGN, OSD POSITION, AUTO SEARCH, BACK COLOUR, STARTUP LOGO, DESK/CEILING, FRONT/REAR, OFF TIMER, FAN CONTROL, LAMP POWER, LAMP RUNTIME

**Care and maintenance**

<b>When the TEMP indicator and the LAMP indicator are illuminated .....</b>	<b>54</b>
<b>Cleaning and replacing the air filter .....</b>	<b>56</b>
<b>Replacing the lamp unit .....</b>	<b>57</b>
<b>Before calling for service .....</b>	<b>60</b>
<b>Cleaning and maintenance .....</b>	<b>61</b>

**Others**

<b>Specifications .....</b>	<b>62</b>
<b>Appendix .....</b>	<b>64</b>
List of compatible signals, General arrangement of the COLOUR MANAGEMENT menu, Using the SERIAL connector, Projection dimensions calculation methods	
<b>Dimensions .....</b>	<b>69</b>
<b>Trademark acknowledgements .....</b>	<b>70</b>

# Precautions with regard to safety

## WARNING

**If you notice smoke, strange smells or noise coming from the projector, disconnect the mains plug from the mains socket.**

- Do not continue to use the projector in such cases, otherwise fire or electric shocks could result.
- Check that no more smoke is coming out, and then contact an Authorised Service Centre for repairs.
- Do not attempt to repair the projector yourself, as this can be dangerous.

**Do not install this projector in a place which is not strong enough to take the full weight of the projector.**

- If the installation location is not strong enough, it may fall down or tip over, and severe injury or damage could result.

**Installation work (such as ceiling suspension) should only be carried out by a qualified technician.**

- If installation is not carried out correctly, there is the danger that injury or electric shocks may occur.

**If foreign objects or water get inside the projector, or if the projector is dropped or the cabinet is broken, disconnect the mains plug from the mains socket.**

- Continued use of the projector in this condition may result in fire or electric shocks.
- Contact an Authorised Service Centre for repairs.

**Do not overload the mains socket.**

- If the power supply is overloaded (for example, by using too many adapters), overheating may occur and fire may result.

**Do not remove the cover or modify it in any way.**

- High voltages can cause fire or electric shocks.
- For any inspection, adjustment and repair work, please contact an Authorised Service Centre.

**Clean the mains plug regularly to prevent it from becoming covered in dust.**

- If dust builds up on the mains plug, the resulting humidity can damage the insulation, which could result in fire. Pull the mains plug out from the mains socket and wipe it with a dry cloth.
- If not using the projector for an extended period of time, pull the mains plug out from the mains socket.

**Do not do anything that might damage the mains lead or the mains plug.**

- Do not damage the mains lead, make any modifications to it, place it near any hot objects, bend it excessively, twist it, pull it, place heavy objects on top of it or wrap it into a bundle.
- If the mains lead is used while damaged, electric shocks, short-circuits or fire may result.
- Ask an Authorised Service Centre to carry out any repairs to the mains lead that might be necessary.

**Do not handle the mains plug with wet hands.**

- Failure to observe this may result in electric shocks.

**Insert the mains plug securely into the mains socket.**

- If the plug is not inserted correctly, electric shocks or overheating could result.
- Do not use plugs which are damaged or mains sockets which are coming loose from the wall.

**Do not place the projector on top of surfaces which are unstable.**

- If the projector is placed on top of a surface which is sloped or unstable, it may fall down or tip over, and injury or damage could result.

**Do not place the projector into water or let it become wet.**

- Failure to observe this may result in fire or electric shocks.

**Do not place liquid containers on top of the projector.**

- If water spills onto the projector or gets inside it, fire or electric shocks could result.
- If any water gets inside the projector, contact an Authorised Service Centre.

**Do not insert any foreign objects into the projector.**

- Do not insert any metal objects or flammable objects into the projector or drop them onto the projector, as doing so can result in fire or electric shocks.

**Do not allow the + and - terminals of the batteries to come into contact with metallic objects such as necklaces or hairpins.**

- Failure to observe this may cause the batteries to leak, overheat, explode or catch fire.
- Store the batteries in a plastic bag and keep them away from metallic objects.

**During a thunderstorm, do not touch the projector or the cable.**

- Electric shocks can result.

**Do not use the projector in a bath or shower.**

- Fire or electric shocks can result.

**Do not look into the lens while the projector is being used.**

- Strong light is emitted from the projector's lens. If you look directly into this light, it can hurt and damage your eyes.
- Be especially careful not to let young children look into the lens. In addition, turn off the power and disconnect the mains plug when you are away from the projector.

**Do not place your hands or other objects close to the air outlet port.**

- Heated air comes out of the air outlet port. Do not place your hands or face, or objects which cannot withstand heat close to this port [allow at least 10cm (4") of space], otherwise burns or damage could result.

**Replacement of the lamp should only be carried out by a qualified technician.**

- The lamp has high internal pressure. If improperly handled, explosion might result.
- The lamp can easily become damaged if struck against hard objects or dropped, and injury or malfunctions may result.

**When replacing the lamp, allow it to cool for at least one hour before handling it.**

- The lamp cover gets very hot, and touching it can cause burns.

**Before replacing the lamp, be sure to disconnect the mains plug from the mains socket.**

- Electric shocks or explosions can result if this is not done.

**Do not allow infants or pets to touch the remote control unit.**

- The accessory remote control unit can be used to operate not only the projector but also other appliances such as air conditioners and electrical device by programming them using the learning function. If the remote control unit operated inappropriately, fire or injury may result.
- Keep the remote control unit out of the reach of infants and pets after using it.

## Caution

**Do not cover the air inlet port or the air outlet port.**

- Doing so may cause the projector to overheat, which can cause fire or damage to the projector.
- Do not place the projector in narrow, badly ventilated places such as closets or bookshelves.

**Do not set up the projector in humid or dusty places or in places where the projector may come into contact with smoke or steam.**

- Using the projector under such conditions may result in fire or electric shocks.

**When disconnecting the mains lead, hold the plug, not the lead.**

- If the mains lead itself is pulled, the lead will become damaged, and fire, short-circuits or serious electric shocks may result.

**Always disconnect all cables before moving the projector.**

- Moving the projector with cables still attached can damage the cables, which could cause fire or electric shocks to occur.

**Do not place any heavy objects on top of the projector.**

- Failure to observe this may cause the projector to become unbalanced and fall, which could result in damage or injury.

**Do not short-circuit, heat or disassemble the batteries or place them into water or fire.**

- Failure to observe this may cause the batteries to overheat, leak, explode or catch fire, and burns or other injury may result.

**When inserting the batteries, make sure the polarities (+ and -) are correct.**

- If the batteries are inserted incorrectly, they may explode or leak, and fire, injury or contamination of the battery compartment and surrounding area may result.

**Use only the specified batteries.**

- If incorrect batteries are used, they may explode or leak, and fire, injury or contamination of the battery compartment and surrounding area may result.

**Do not mix old and new batteries.**

- If the batteries are inserted incorrectly, they may explode or leak, and fire, injury or contamination of the battery compartment and surrounding area may result.

**Do not put your weight on this projector.**

- You could fall or the projector could break, and injury may result.
- Be especially careful not to let young children stand or sit on the projector.

**Disconnect the mains plug from the mains socket as a safety precaution before carrying out any cleaning.**

- Electric shocks can result if this is not done.

**Ask an Authorised Service Centre to clean inside the projector at least once a year.**

- If dust is left to build up inside the projector without being cleaned out, it can result in fire or problems with operation.
- It is a good idea to clean the inside of the projector before the season for humid weather arrives. Ask your nearest Authorised Service Centre to clean the projector when required. Please discuss with the Authorised Service Centre regarding cleaning costs.

**We are constantly making efforts to preserve and maintain a clean environment. Please take non repairable units back to your dealer or a recycling company.**

# Accessories

Check that all of the accessories shown below have been included with your projector.

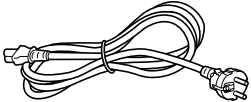
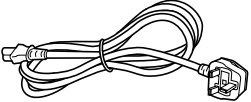
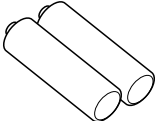
<p>Remote control unit (EUR7914Z20 x1)</p> 	<p>Mains lead for Continental (K2CM3FR00002 x1)</p> 	<p>Mains lead for U.K. (K2CT3FR00003 x1)</p> 
	<p>AA batteries for remote control unit (x2)</p> 	

# Before use

## Cautions regarding setting-up

**Avoid setting up in places which are subject to vibration or shocks.**  
The internal parts can be damaged, which may cause malfunctions or accidents.

**Avoid setting up in places which are subject to sudden temperature changes, such as near an air conditioner.**  
The life of the lamp may be shortened.

**Do not set up the projector near high-voltage power lines or near motors.**  
The projector may be subject to electromagnetic interference.

**If installing the projector to the ceiling, ask a qualified technician to carry out all installation work.**  
You will need to purchase the separate installation kit (Model No.ET-PKE300/ET-PKE700). Furthermore, all installation work should only be carried out by a qualified technician.

**If using this projector at high elevations (above 1 400 m), set the “FAN CONTROL” to “HIGH”. (Refer to page 52.)**  
Failure to observe this may result in malfunctions.



# Location and function of each part

## Notes on use

### In order to get the best picture quality

Draw curtains or blinds over any windows and turn off any lights near the screen to prevent outside light or light from indoor lamps from shining onto the screen.

### Do not touch the surfaces of the lens with your bare hands.

If the surface of the lens becomes dirty from fingerprints or anything else, this will be magnified and projected onto the screen. Moreover, when not using the projector, retract the lens and then cover it with the lens cover.

### Screen

Do not apply any volatile substances which may cause discolouration to the screen, and do not let it become dirty or damaged.

### Lamp

The lamp may need to be replaced earlier due to variables such as individual lamp characteristics, usage conditions and the installation environment, especially when the projector is subjected to continuous use for more than 10 hours or the power is frequently turned on and off.

### Liquid crystal panel

- Do not project the same image for long periods of time, as this may remain as an afterimage on the liquid crystal panel.
- The liquid crystal panel of the projector is built with very high precision technology to provide fine picture details. Occasionally, a few non-active pixels may appear on the screen as fixed points of blue, green or red. Please note that this does not affect the performance of your LCD.

## Projector <Top, right and front>

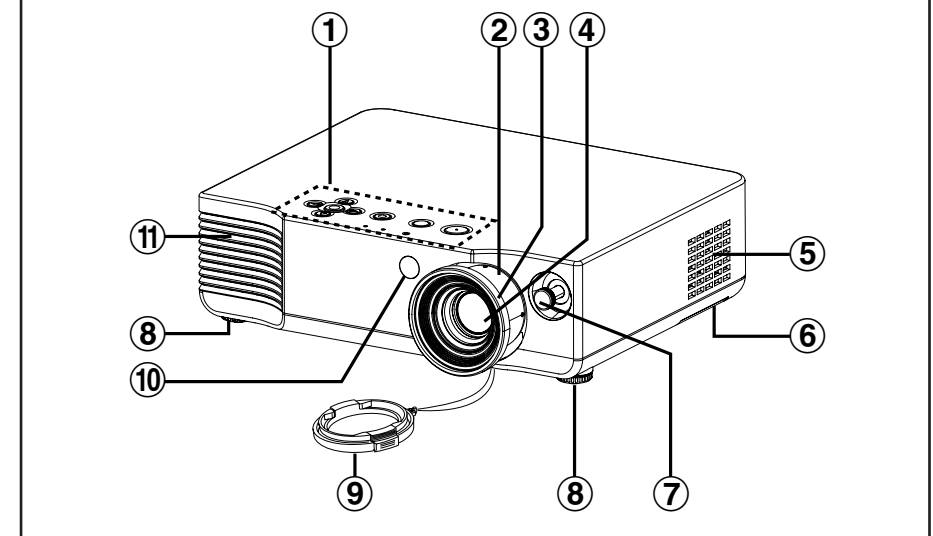

- ① **Projector control panel** (page 16)
- ② **Zoom ring** (page 27)
- ③ **Focus ring** (page 27)
- ④ **Projection lens**
- ⑤ **Air inlet port**  
Do not cover this port.
- ⑥ **Air filter** (page 56)
- ⑦ **Shift lever** (page 27)  
This lever adjusts the lens direction.
- ⑧ **Front adjustable legs (L/R)** (page 27)
- ⑨ **Lens cover**
- ⑩ **Remote control signal receptor** (page 25)
- ⑪ **Air outlet port**  
Do not cover this port.

## WARNING

**Do not place your hands or other objects close to the air outlet port.**

- Heated air comes out of the air outlet port. Do not place your hands or face, or objects which cannot withstand heat close to this port [allow at least 10cm (4") of space], otherwise burns or damage could result.

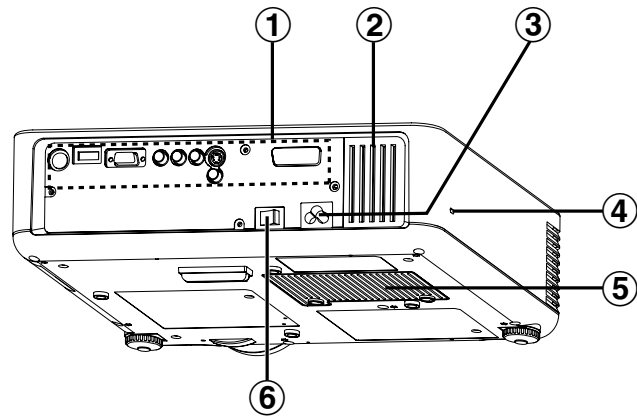
**Projector** <Back and bottom>

① **Connector panel** (page 15)

② **Air inlet port**

Do not cover this port.

③ **Power input socket (AC IN)** (page 26)

The accessory mains lead is connected here.

Do not use any mains lead other than the accessory mains lead.

④ **Security lock**

This can be used to connect a commercially-available theft-prevention cable (manufactured by Kensington). This security lock is compatible with the Microsaver Security System from Kensington.

⑤ **Lamp unit cover** (page 57)

⑥ **MAIN POWER switch** (pages 26 and 28)

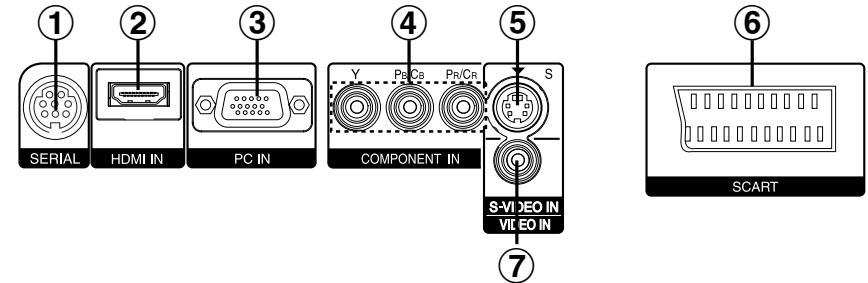
**Connector panel**

① **SERIAL connector** (pages 22, 23, 24 and 66)

This connector is used to connect a personal computer to the projector in order to control the projector externally. (RS-232C compatible)

② **HDMI IN connector** (page 23)

This connector is used to input HDMI signals.

③ **PC IN (RGB input) connector** (page 24)

This connector is used to input RGB signals from a PC.

④ **COMPONENT IN [YPbPr(CbCr) input] connectors** (page 22)

These connectors are used to input YPbPr signals from compatible equipment such as a DVD player.

⑤ **S-VIDEO IN connector** (page 22)

This connector is used to input signals from an S-VIDEO-compatible equipment such as a video deck.

⑥ **SCART connector**(page 22)

This connector is used to input SCART signals.

⑦ **VIDEO IN connector** (page 22)

This connector is used to input video signals from a video equipment such as a video deck.



## Projector control panel

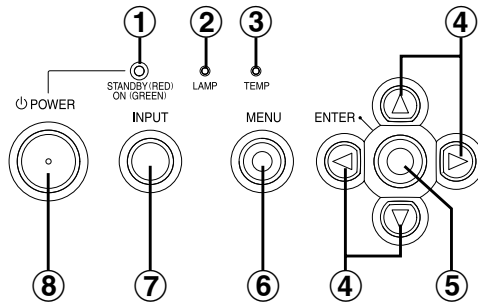

## Remote control unit

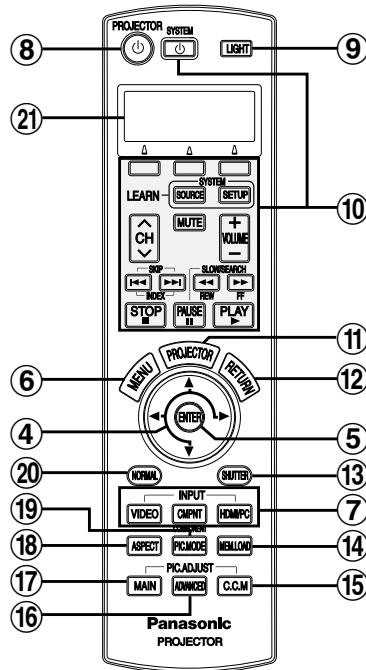

### ① Power indicator (pages 26, 28 and 29)

This indicator illuminates red when the main power is switched on (standby mode), and it illuminates green when a picture starts to be projected.

### ② LAMP indicator (page 55)

This indicator illuminates when it is time to replace the lamp unit. It flashes if a circuit abnormality is detected.

### ③ TEMP indicator (page 54)

This indicator illuminates if an abnormally high temperature is detected inside the projector. If the temperature rises above a certain level, the power supply will be turned off automatically and the indicator will flash.

### ④ Arrow (▲, ▼, ◀ and ▶) buttons (page 42)

These buttons are used to select and adjust items in the on-screen menus.

### ⑤ ENTER button (page 42)

This button is used to accept and to activate items selected in the on-screen menus.

### ⑥ MENU button (page 40)

This button is used to display the menu screen. When a menu screen is being displayed, it can be used to return to a previous screen or to clear the screen.

### ⑦ INPUT select buttons (page 27)

These buttons are used to switch the input signals from the connected equipment.

### ⑧ POWER button (pages 26 and 28)

### ⑨ LIGHT button (page 33)

This button is used to illuminate the buttons on the remote control unit.

### ⑩ Buttons to operate the selected device

These buttons are used to operate the devices which have been programmed into the remote control unit or the devices which have been programmed using the leaning function of the remote control unit. Refer to the Operating Instructions for the remote control unit for details.

### ⑪ PROJECTOR button

Buttons from ④ to ⑥ and ⑫ are used to operate both the projector and the other devices which have been programmed in the remote control unit. Press this button before operating the projector.

### ⑫ RETURN button (page 42)

When a menu screen is being displayed, this button is used to return to a previous screen or to clear the screen.

### ⑬ SHUTTER button (page 34)

This button is used to momentarily turn off the picture.

### ⑭ MEM. LOAD (MEMORY LOAD) button (page 34)

This button is used to display the "MEMORY LOAD" menu.

### ⑮ C.C.M (Cinema Colour Management) button (page 36)

This button is used to display the "COLOUR MANAGEMENT" menu.

### ⑯ ADVANCED button (pages 35 and 46)

This button is used to display an item from the "ADVANCED MENU".

### ⑰ MAIN button (pages 35 and 44)

This button is used to display an item from the "PICTURE" menu.

### ⑱ ASPECT button (page 30)

This button is used for aspect adjustment (vertical and horizontal proportions).

### ⑲ PIC. MODE (PICTURE MODE) button (page 33)

Pressing this button will change the picture mode.

### ⑳ NORMAL button (page 43)

This button is used to reset the projector adjustment values to the factory default settings.

### ㉑ LCD display

The selected device is displayed at the upper side, and the guide for the leaning function and button operation for the remote control unit is displayed at the lower side. Refer to the Operating Instructions for the remote control unit for details.

# Setting-up

## Projection methods

In way of installing projector, any one of the following four projection methods are used. Select whichever projection method matches the setting-up method. (The projection method can be set from the "OPTION" menu. Refer to page 52 for details.)

### ● Front-desk projection

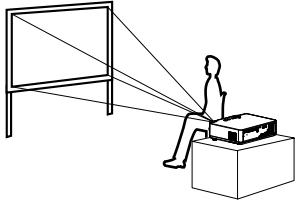

Menu items	Setting
DESK/CEILING	DESK
FRONT/REAR	FRONT

### ● Rear-desk projection (Using a translucent screen)

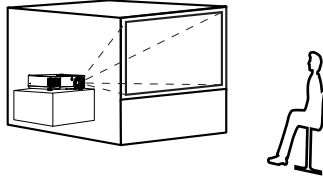

Menu items	Setting
DESK/CEILING	DESK
FRONT/REAR	REAR

### ● Front-ceiling projection

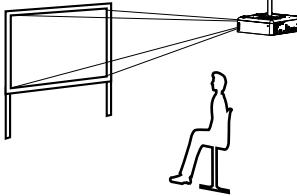

Menu items	Setting
DESK/CEILING	CEILING
FRONT/REAR	FRONT

### ● Rear-ceiling projection (Using a translucent screen)

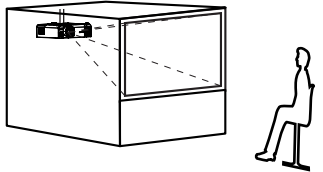

Menu items	Setting
DESK/CEILING	CEILING
FRONT/REAR	REAR

#### NOTE:

- You will need to purchase the separate ceiling bracket (ET-PKE300/ET-PKE700) when using the ceiling installation method.
- Do not set up the projector vertically or tilted horizontally, otherwise it may cause damage to the projector.
- It is recommended that you set up the projector in a place that is tilted at less than  $\pm 30^\circ$  vertically. Setting up the projector in places that are tilted at more than  $\pm 30^\circ$  vertically may shorten component life.

## Projector position

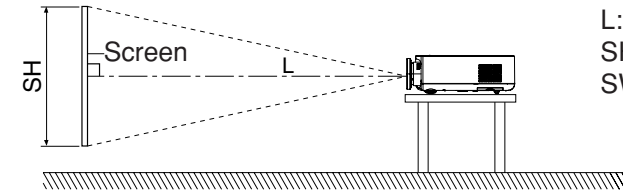

L: Projection distance  
SH: Image height  
SW: Image width

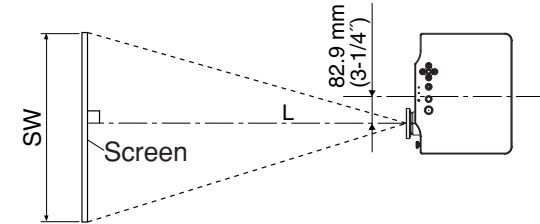

#### NOTE:

- Place the projector so that it is vertical to the screen.

## Projection distances

Screen size (16:9)			Projection distance (L)	
Diagonal length	Height (SH)	Width (SW)	Wide (LW)	Telephoto (LT)
1.01 m(40")	0.50 m(1'7")	0.89 m(2'11")	1.2 m(3'11")	2.4 m(7'10")
1.27 m(50")	0.62 m(2')	1.11 m(3'7")	1.5 m(4'11")	3.0 m(9'10")
1.52 m(60")	0.75 m(2'5")	1.33 m(4'4")	1.8 m(5'10")	3.7 m(12'1")
1.77 m(70")	0.87 m(2'10")	1.55 m(5'1")	2.1 m(6'10")	4.3 m(14'1")
2.03 m(80")	1.00 m(3'3")	1.77 m(5'9")	2.4 m(7'10")	4.9 m(16')
2.28 m(90")	1.12 m(3'8")	1.99 m(6'6")	2.7 m(8'10")	5.5 m(18')
2.54 m(100")	1.24 m(4')	2.21 m(7'3")	3.1 m(10'2")	6.2 m(20'4")
3.05 m(120")	1.49 m(4'10")	2.66 m(8'8")	3.7 m(12'1")	7.4 m(24'3")
3.81 m(150")	1.87 m(6'1")	3.32 m(10'10")	4.6 m(15'1")	9.3 m(30'6")
5.08 m(200")	2.49 m(8'2")	4.43 m(14'6")	6.2 m(20'4")	12.4 m(40'8")

#### NOTE:

- The dimensions in the table above are approximate.
- For details about projected image distances, refer to page 69.

## Setting up range using the lens shift function

This projector can be placed in various places by controlling the shift lever at the front side of the projector to move the lens in order to adjust the position of the projected image.

### • Vertical lens shift

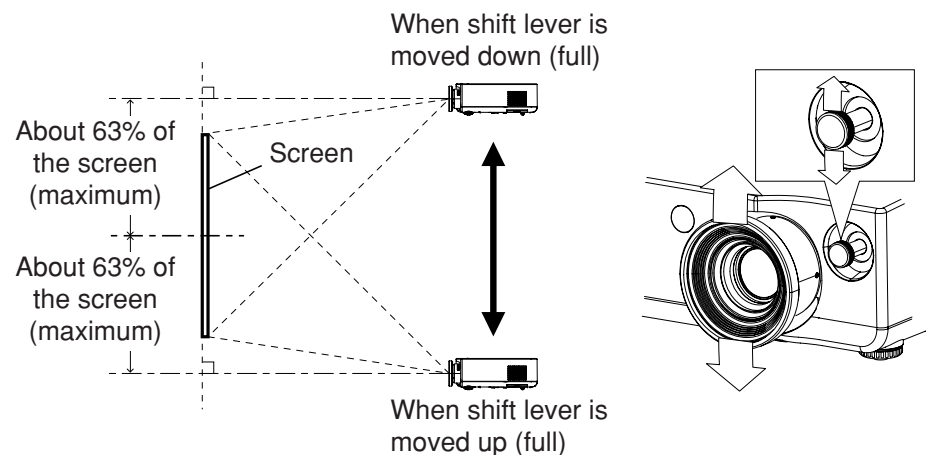

### • Horizontal lens shift

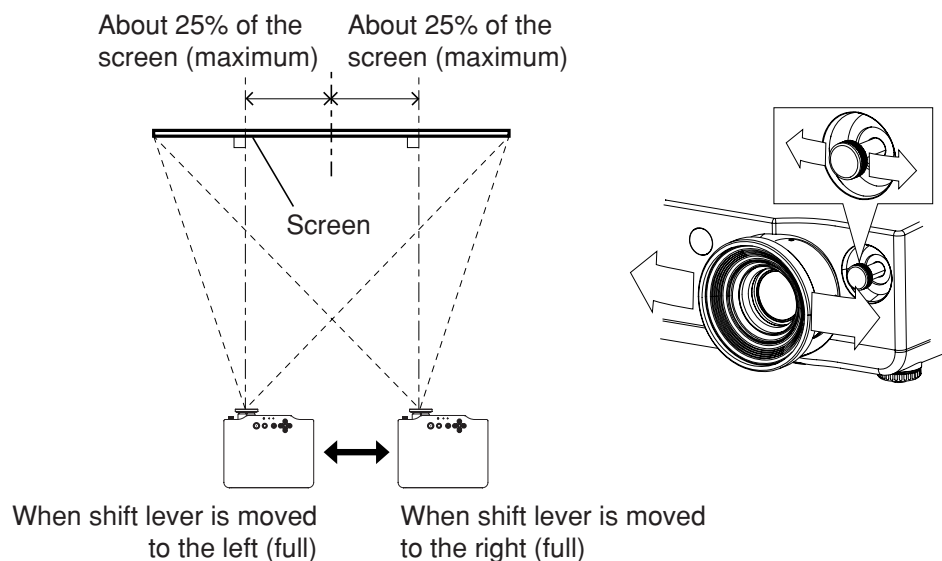

### • Projector setting up range in relation to the screen

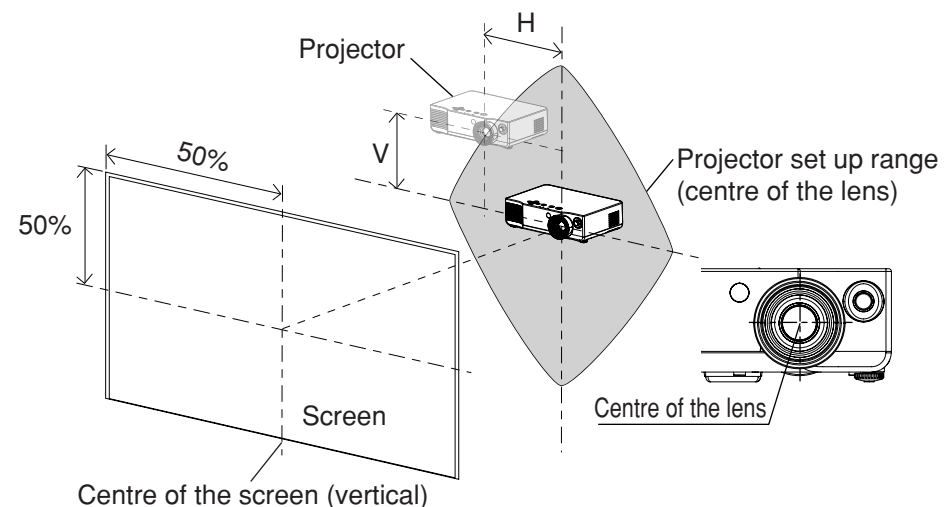

Vertical (V)	Horizontal shift range	Shift lever operation range
About 63%	About 0%	When the lens has been shifted fully up or down.
About 50%	About 8%	When the centre of the lens is placed at the same height as the upper or lower edge of the screen.
About 0%	About 25%	When the lens is shifted only to the right or left.

\* The values in the table are for the width and the height of the screen.

#### NOTE:

- Turn the shift lever right to secure the shift lever.
- When the lens has been shifted fully to the right or left, you will not be able to shift the lens up or down.  
When the lens has been shifted fully up or down, you will not be able to shift the lens to the right or left.
- Generally, the maximum picture quality is obtained when the lens is moved to the centre (horizontally and vertically).
- When the projector is tilted vertically and keystone correction needs to be carried out, place the projector so that the centre of the lens and the centre of the screen (vertical) are matched.

# Connections

## Notes on connections

- Read the instruction manual for each peripheral device carefully before connecting it.
- Turn off the power supply for all peripheral devices before making any connections.
- If the cables necessary for connection are not included with the peripheral device or available as an option, you may need to prepare a proper cable for the device concerned.
- Refer to the list on page 64 for details on compatible signals which can be input to the projector.
- An audio system circuit is not provided with this projector. Connect the audio output of the connected equipment to a separate audio system.

## Connecting to video equipment

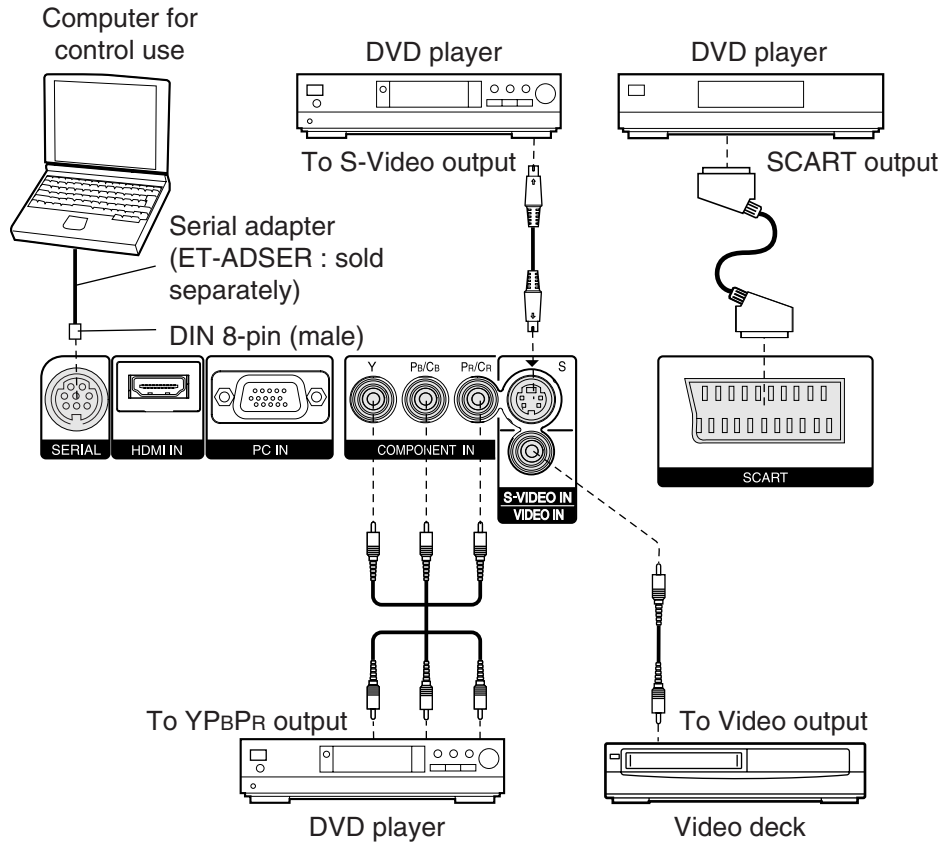

### NOTE:

- When the device connected to SCART is turned on, the input select setting will be switched to SCART automatically, and "ASPECT" (page30) will also be set automatically. (When "WSS" is set to "ON", refer to page 49 for details.)

## Connecting to equipment compatible with HDMI

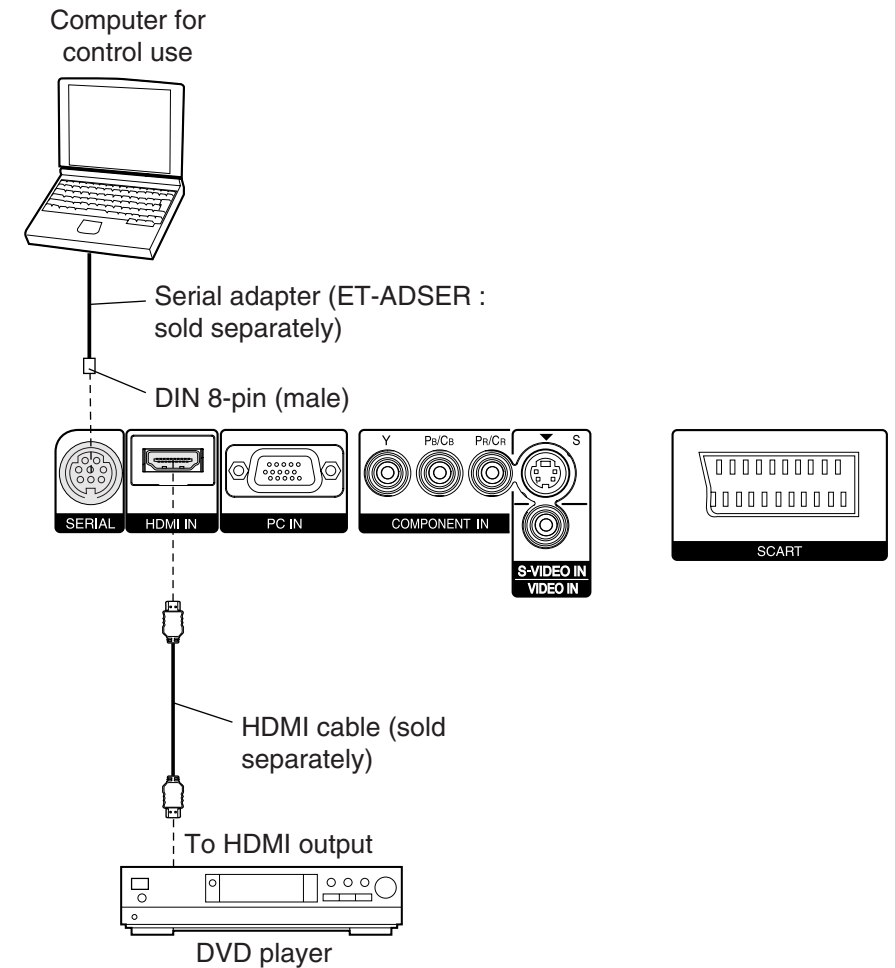

### NOTE:

- Use the HDMI cable with the HDMI logo.
- When connecting to equipment compatible with DVI, use the DVI - HDMI adapter cable (sold separately).
- This projector can be connected to HDMI and DVI equipment, but some equipment may not operate correctly, for example images may not appear.

## Connecting to computer

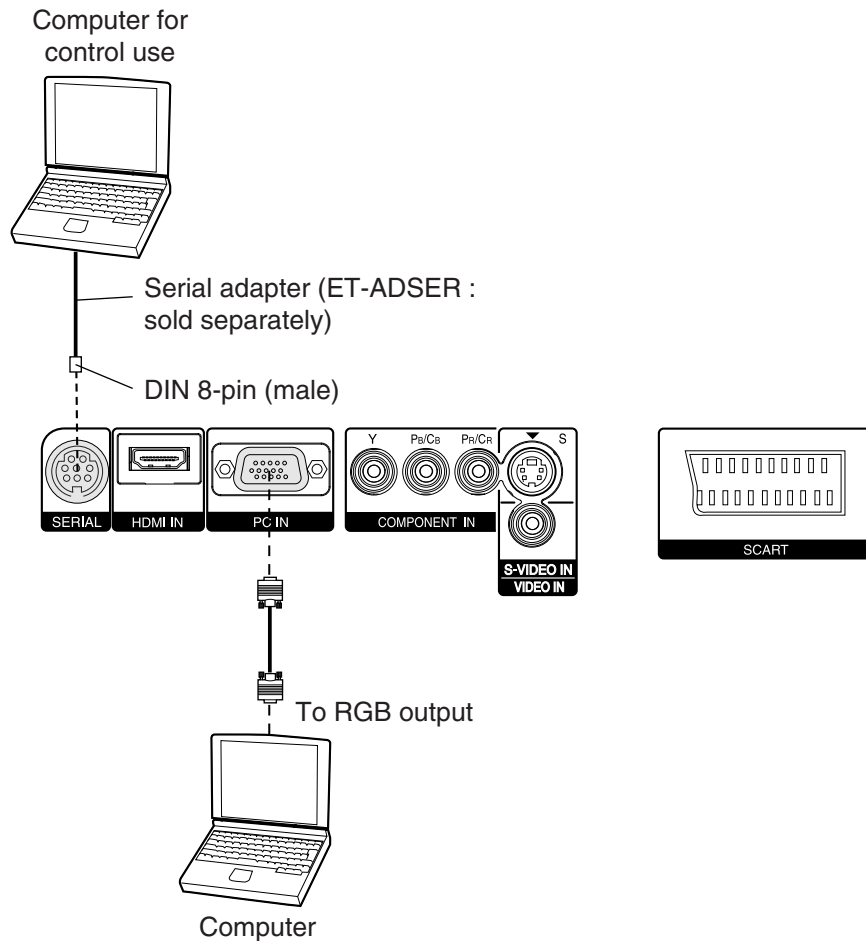

## Preparation for the remote control unit

① Open the cover.

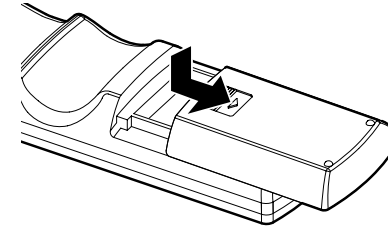

② Insert the batteries so that the polarities are correct, and then close the cover.

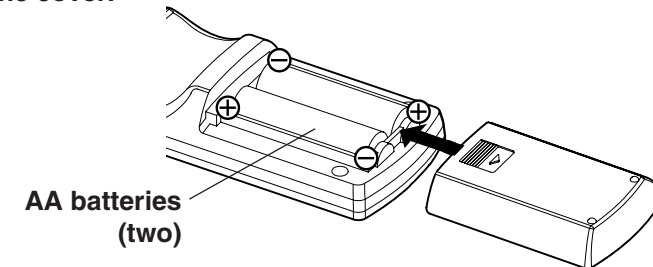

### NOTE:

- Do not drop the remote control unit.
- Keep the remote control unit away from liquids.
- Remove the batteries if not using the remote control unit for long periods.
- Do not use rechargeable batteries.

### Operating range

If the remote control unit is held so that it is facing directly in front of the remote control signal receptor, the operating range is within approximately 7 m (23') from the surfaces of the receptor. Furthermore, the remote control unit can be operated from an angle of  $\pm 30^\circ$  to the left or right and  $\pm 15^\circ$  above or below the receptor.

### NOTE:

- If the buttons on the remote control unit are kept pressed, the battery power will be consumed rapidly.
- If there are any obstacles in between the remote control unit and the receptor, the remote control unit may not operate correctly.
- If strong light is allowed to shine onto the remote control signal receptor, correct projector operation may not be possible. Place the projector as far away from light sources as possible.
- If facing the remote control unit toward the screen to operate the projector, the operating range of the remote control unit will be limited by the amount of light reflection loss caused by the characteristics of the screen used.

# Turning on the power

## Before turning on the power

1. Ensure that all peripheral devices are connected properly.
2. Connect the accessory mains lead.
3. Remove the lens cover.

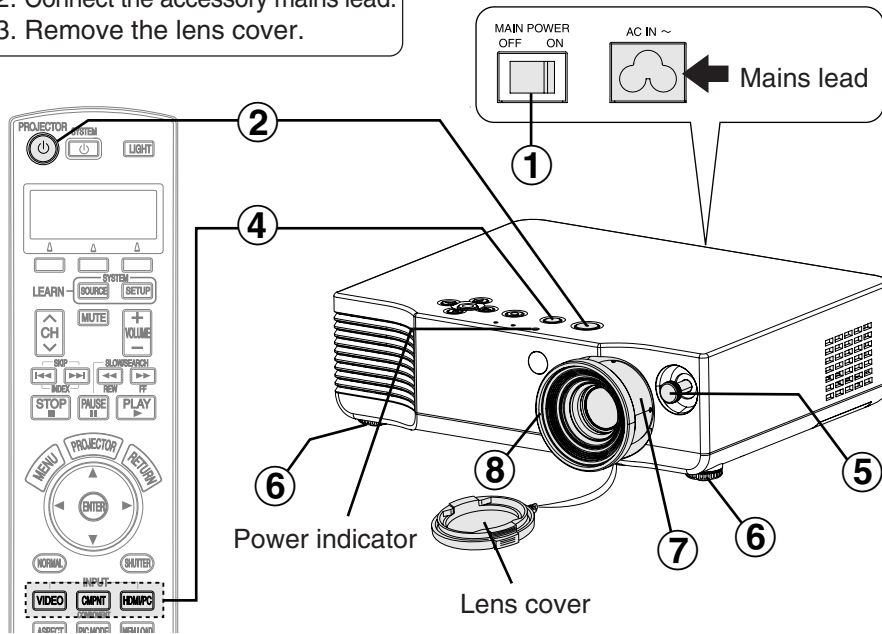

## 1 Press the MAIN POWER switch to turn on the power.

- The power indicator on the projector will illuminate red.

## 2 Press the POWER button.

- The power indicator on the projector will flash green. After a short period, the indicator will illuminate green, and the startup logo will be displayed. If you would like the startup logo not to be displayed, set "STARTUP LOGO" to "OFF". (Refer to page 52.)

## 3 Turn on the power of all connected devices.

- Start the play function of a device such as a DVD player.

### NOTE:

- A rattling sound may be heard when the power is turned on, and a tinkling sound may be heard when the lamp unit is turned on, but these are not signs of malfunctions.

## 4 Press the input select button to select the input signal.

		INPUT		
Control panel	Input select button			
	Changing signals	VIDEO	S-VIDEO	YPbPr
Remote control unit	Input select button	VIDEO	COMPNT	HDM/PC
	Changing signals	S-VIDEO	SCART	HDMI

Diagram showing signal flow: VIDEO ↔ S-VIDEO ↔ YPbPr ↔ SCART ↔ PC ↔ HDMI ↔ VIDEO.

- A picture will be projected in accordance with the selected input signal.

Follow the procedure below when you set the projector up first, and when you change the setup place.

## 5 Adjusting the lens shift

- Use the shift lever to adjust the position of the projected image.
- Turn the shift lever right to secure the shift lever, and left to release the shift lever. Do not pull the shift lever while adjusting the lens shift.

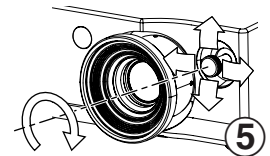

## 6 Adjusting the angle

- The position of the projected image (upward and downward) can be fine adjusted by turning the front adjustable legs.
- If the projected image contains keystone distortion, adjust "KEYSTONE" in the "POSITION" menu (refer to page 49 for details).

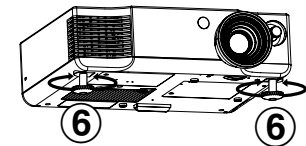

## 7 Adjusting the size

- Turn the zoom ring to adjust the size of the projected image.

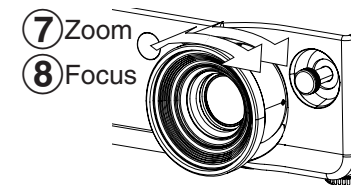

## 8 Adjusting the focus

- Turn the focus ring to adjust the focus of the projected image.



# Turning off the power

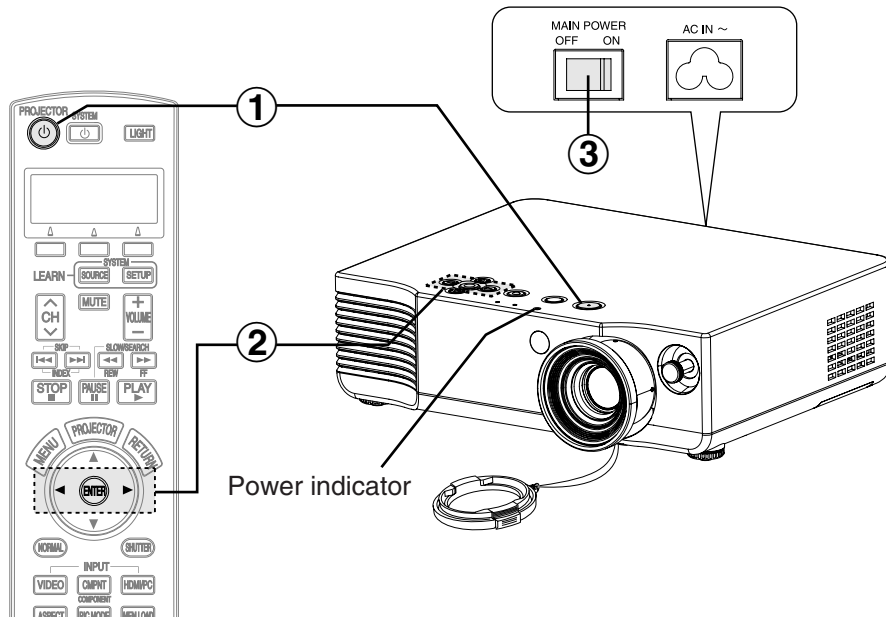

## 1 Press the POWER button.

- A confirmation screen is displayed on the screen.

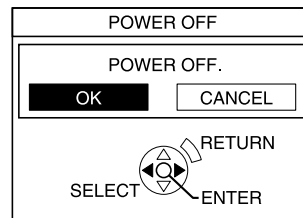

## 2 Press the ◀ or ▶ button to select “OK”, and then press the ENTER button.

- The lamp unit will switch off and the picture will stop being projected. (The power indicator on the projector will illuminate orange while the cooling fan is still operating.)

## 3 Press the MAIN POWER switch to turn off the power after the power indicator on the projector illuminates red.

- Do not cut power to the projector in any way while the cooling fan is still operating. Be careful not to switch off the MAIN POWER switch of the projector or unplug the mains lead from the mains socket.

### NOTE:

- During projection of an image, the cooling fan will operate, emitting a small noise as it operates. Turning the lamp on or off will cause this noise to increase a little.
- By using the “OPTION” menu to set “LAMP POWER” to “LOW”, the operating sound of the fan can be reduced. (Refer to page 53.)
- You can also turn off the power by pressing the POWER button twice or by holding it down for at least 0.5 seconds.
- When the projector is in standby mode (the power indicator on the projector is illuminated red), the projector continues to draw approximately 0.07 W of power even when the cooling fan has stopped.

### Power indicator

Power indicator status		Projector status
Red	Illuminated	The projector is in standby mode and image projection is possible by pressing the POWER button.
Green	Flashing	The projector is preparing for projection after the power is turned on while the power indicator is illuminated red. (After a short period, a picture will be projected.)
	Illuminated	A picture is being projected.
Orange	Illuminated	The lamp is cooling down after the power is turned off. (The cooling fan is operating.)
	Flashing	The projector is preparing for projection after the power is turned on while the power indicator is illuminated orange. (After a short period, a picture will be projected.)

# Setting the aspect ratio (ASPECT)

This projector allows you to change the aspect ratio to match the type of input signal.

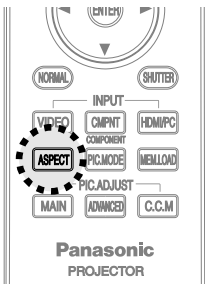

## Press the ASPECT button.

- Pressing the ASPECT button will change the aspect ratio according to the successive settings shown below.
- Illustrations for aspect ratio settings are shown on the next page. Refer to this illustration for assistance in selecting a suitable aspect ratio.

<b>S-VIDEO/VIDEO/ YPbPr/SCART</b>	AUTO→4:3→16:9→14:9→ZOOM1→ZOOM2 [When an NTSC, 525i (480i) or 525p (480p) YPbPr signal is being input] AUTO→4:3→16:9→JUST→ZOOM
	[When a 525i (480i) SCART signal is being input] 4:3→16:9→JUST→ZOOM
<b>PC</b>	4:3→16:9→V SCROLL **“V SCROLL” cannot be set when a VGA or SVGA signal is being input.
<b>HDMI</b>	4:3→16:9
	[When a 525p (480p) or 625p (576p) signal is being input] 4:3→16:9→JUST→ZOOM

- When “WSS” is set to “ON”(page 49), the projector switches the aspect ratio automatically if the input signal has a detector signal.
- “WIDE” is displayed on the screen when “ASPECT” is set automatically (when “WSS” is set to “ON”). Press the ASPECT button to switch the aspect ratio.
- The aspect ratios for the following signals are fixed, and cannot be changed. (Refer to page 64.)  
**1 125 (1 080) /60i, 1 125 (1 080) /50i, 1 125 (1 080)/24p, 750 (720) /60p, 750 (720) /50p, WIDE 480/600/720/768/768-2**  
\*WIDE768 signals can be set to “V SCROLL”.
- “AUTO” will be displayed according to the type of the signals being input. When set to “AUTO”, the projector switches the aspect ratio automatically if the input signal has a detector signal.
- When set to “V SCROLL”, vertical position can be adjusted by pressing the ▼ and ▲ buttons (close the menu screen before adjusting the vertical position).

ASPECT	Input signal	Projected image
<b>4:3</b>	4:3 input signal 	4:3 
<b>16:9</b>	Squeezed signal (image contracted horizontally) 	Horizontal expansion of projected image 
<b>14:9</b>	14:9 letterbox signal 	Expansion preserves original ratio 
<b>JUST</b>	4:3 input signal 	Horizontal expansion of projected image (Centre of image is less distorted.) 
<b>ZOOM ZOOM1 ZOOM2*</b>	Letterbox signal 	Expansion preserves original ratio 
<b>V SCROLL (XGA/MXGA/SXGA/ WIDE768 only)</b>	4:3 input signal 	A picture is projected without expansion or reduction. 

\*“ZOOM2” is for 2.35 : 1 letterbox signals.

**NOTE:**

- If a selected mode does not match the aspect ratio of the input signal, it may affect the quality of viewing of the original picture.
- If using this projector in places such as cafes or hotels to display programmes for a commercial purpose or for public presentation, note that if the aspect ratio selection function is used to change the aspect ratio of the screen picture, you may be infringing the rights of the original copyright owner for that programme under copyright protection laws.
- If a 4:3 picture is projected onto a 16:9 screen, distortion may occur around the edges of the picture so that part of the picture is no longer visible. Programmes which have 4:3 aspect ratios should be viewed in 4:3 mode to give proper consideration to the aims and intentions of the original programme's creator.
- Image sizes such as Cinema-Vision that project wider than the 16:9 ratio will have narrow black fields at the top and bottom.
- You can also change the aspect ratio from the "POSITION" menu.

## Selecting the picture mode (PIC. MODE)

You can select the appropriate picture mode for the type of projected image.

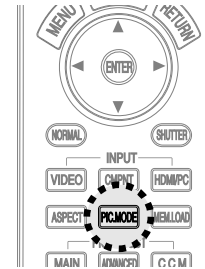

**Press the PIC. MODE button.**

- Pressing the PIC. MODE button will change the picture mode.

**NORMAL** .....When watching various image sources.

**DYNAMIC** .....When the projector is used in a bright room.

**CINEMA1** .....When watching movies. The projected image will be refined.  
This mode was well tuned to the look of Hollywood movie.

**CINEMA2** .....When watching movies. The projected image will be clear and have high contrast.

**CINEMA3** .....When watching movies. The projected image will have deep, rich colours.

**VIDEO** .....When watching video sources such as music or sports programs.

**NATURAL** .....To reproduce the colour of the image faithfully from the image source.

**NOTE:**

- The picture mode can also be selected from "PICTURE MODE" in the "PICTURE" menu.
- When the "PICTURE MODE" menu is selected, the settings will switch automatically to the last "PROFILE" settings (page 36) that were used for the selected picture mode.

## Turning on the button lights (LIGHT)

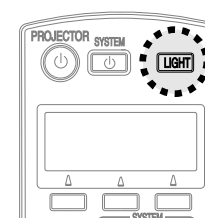

**Press the LIGHT button.**

- The buttons on the remote control unit will be illuminated.
- Press the LIGHT button again to turn off the button lights. The button lights will be turned off automatically when no buttons on the remote control unit are pressed for 10 seconds.

## Retrieving the saved picture settings (MEM. LOAD)

If you have saved the adjusted picture settings using the “MEMORY SAVE” menu, you can retrieve the saved picture settings.

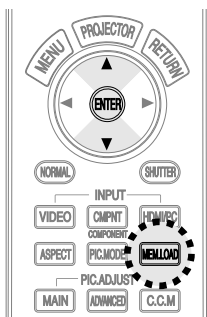

Press the MEM. LOAD button.

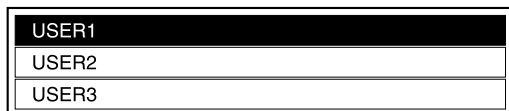

- Press the ▲ or ▼ button to select the setting you want to retrieve, then press the ENTER button.

### NOTE:

- Only the settings saved in the “MEMORY SAVE” menu will be displayed in the “MEMORY LOAD” menu. (Refer to page 47.)

## Turning off the picture momentarily (SHUTTER)

The “SHUTTER” function can be used to momentarily turn off the picture when the projector is not being used for short periods of time. The projector uses less power in “SHUTTER” mode than it does in normal projection mode.

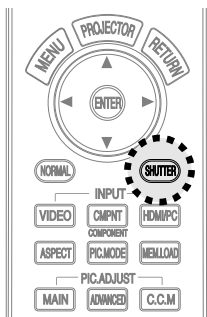

Press the SHUTTER button.

- The picture will be turned off.
- Press any button on either the projector or remote control unit (except the LIGHT button) to return to normal operating mode.

## Displaying the “PICTURE” menu (MAIN)

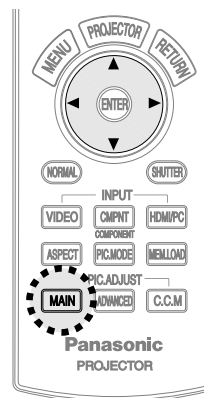

Press the MAIN button.

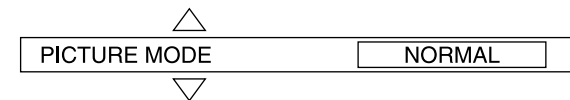

- The individual adjustment screen will be displayed as shown above. Press the ▲ or ▼ button to switch the item.
- Press the ◀ or ▶ button to adjust the value or change the setting.
- You can adjust “PICTURE” menu items using selective settings or the bar scale only.
- The screen display will be cleared when the MENU button or the RETURN button is pressed, or when no operation is carried out for 3 seconds.
- Refer to page 44 for details on the “PICTURE” menu.

## Displaying the “ADVANCED MENU” (ADVANCED)

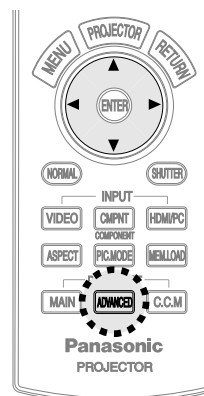

Press the ADVANCED button.

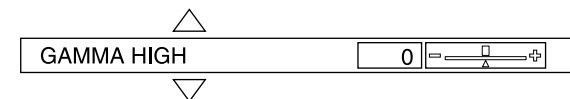

- The individual adjustment screen will be displayed as shown above. Press the ▲ or ▼ button to switch the item.
- Press the ◀ or ▶ button to adjust the value.
- You can adjust “ADVANCED MENU” items with the bar scale only.
- The screen display will be cleared when the MENU button or the RETURN button is pressed, or when no operation is carried out for 3 seconds.
- Refer to page 46 for details on the “ADVANCED MENU”.

# Using the Cinema Colour Management function(C.C.M)

You can adjust, save, and retrieve the settings for the selected colours of the projected image based on the selected picture mode to suit your preference.

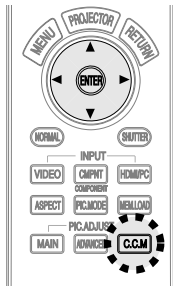

Press the ▲ or ▼ button to select an item, press the ◀ or ▶ button to change the settings, and press the ENTER button for confirmation.

**Press the C.C.M button.**

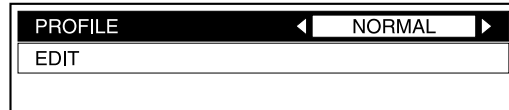

## PROFILE

- Retrieves the saved profile (colour settings which have been adjusted).

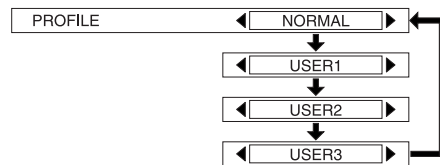

**NORMAL** When projecting images according to the setting of "PICTURE MODE" (page 33). This setting is the factory default setting.

**USER1/2/3** These items are displayed only when "PROFILE SAVE" has been carried out. Refer to page 39 for details.

## EDIT

- You can edit the settings for the selected colour.

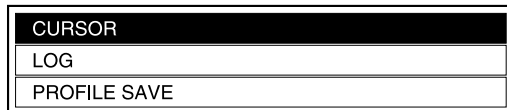

**CURSOR** Lets you select a colour, and adjust the colour settings (page 37).

**LOG** Lets you adjust the colour settings again, or delete the settings (page 38).

**PROFILE SAVE** Lets you save the adjusted colour settings (page 39).

### NOTE:

- Refer to page 65 for the general arrangement of the "COLOUR MANAGEMENT" menu.
- You can enter the "COLOUR MANAGEMENT" menu from the "ADVANCED MENU" in the "PICTURE" menu (page 46).

- When the "PICTURE MODE" menu is selected, the settings will switch automatically to the last "PROFILE" settings that were used for the selected picture mode.
- When retrieving a profile, "EDIT" will not be displayed if the picture mode being selected does not match the picture mode which had been selected when that profile was saved.
- "LOG" and "PROFILE SAVE" are displayed only when the colours have been adjusted in "CURSOR" menu.

## CURSOR

Press the ENTER button to display the cursor (B).

### ① Select the colour you want to adjust with the cursor.

- Press the ▲, ▼, ◀ and ▶ buttons to move the cursor, and then press the ENTER button.
- The selected colour (C) and the adjustment menu (A) will be displayed.

### ② Adjust the items in the adjustment menu.

- The colour adjusted in the adjustment menu (D) will be displayed.

**COLOUR** Adjusts the deepness of the colour.

**TINT** Adjusts the hue of the colour.

**BRIGHT** Adjusts the brightness of the colour.

### ③ Press the ENTER button to apply the adjusted colour.

- The letters PROCESSING and the progress status bar will be displayed while the adjusted colour is applied.
- The adjusted colour settings will be saved in the "LOG" menu.

If you would like to continue to adjust another colour after adjusting a colour, press the MENU button or the RETURN button on the remote control unit, and then repeat the steps from step ①.

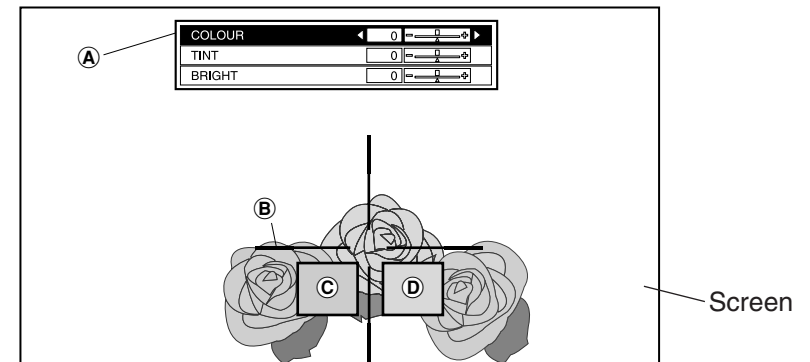

### ④ Press the MENU button or the RETURN button on the remote control unit twice, and then save the adjusted colour settings.

- Select the "PROFILE SAVE" menu from the "EDIT" menu. The adjusted colour settings will not be saved until you carry out "PROFILE SAVE".

## NOTE:

- The projected image will be paused when the cursor is displayed. Press the MENU button or the RETURN button on the remote control unit to cancel the still image. (If an adjustment menu is displayed, press the MENU button or the RETURN button twice.)
- When there are same or similar colours in the projected image, these colours will also be changed.
- The colours white, gray and black cannot be adjusted.
- If the same colours are adjusted separately, these colours may not be adjusted to suit your preference.
- You can adjust a maximum of 8 colours (“POINT.1-8”) for each user (“USER1/2/3”). The cursor will not be displayed when 8 colours have already been adjusted.

## LOG

PICTURE MODE : CINEMA1			
	COLOUR	TINT	BRIGHT
POINT1	0	0	+2
POINT2	-1	0	-2
POINT3	0	+10	0
POINT4	-10	+10	-10
POINT5	-6	+5	+7
POINT6	+3	-3	+1
POINT7	0	+7	+9
POINT8	-1	+14	-4
ALL DELETE			

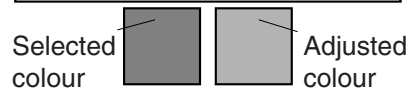

CHANGE
DELETE

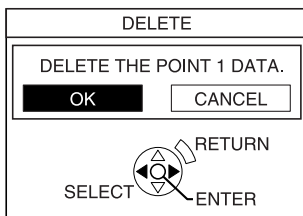

Press the ENTER button to display the “LOG” menu.

Press the ▲ or ▼ button to select the setting you want to adjust, and then press the ENTER button to display the selection screen.

To delete all the settings, select “ALL DELETE”, and then press the ENTER button. The confirmation screen will then be displayed. Select “OK” and then press the ENTER button. All the settings in the “LOG” menu will be deleted, and the “PROFILE” setting will return to “NORMAL”.

## CHANGE

The adjustment menu (page 37 ) will be displayed. You can adjust the colour settings again.

## DELETE

The selected colour setting will be deleted. The confirmation screen will be displayed when the ENTER button is pressed. Select “OK” to delete the settings.

## PROFILE SAVE

USER1
USER2
USER3

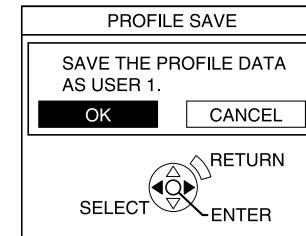

Press the ENTER button to display the “PROFILE SAVE” menu.

Press the ▲ or ▼ button to select the number (“USER1/2/3”) in which you want to save the setting, and then press the ENTER button. The confirmation screen will then be displayed. Select “OK” to save the settings.

## NOTE:

- After saving the adjusted settings, the “PROFILE” setting will automatically change to the setting saved in the “PROFILE SAVE” menu. If you continue to adjust colours to make other profiles, change the “PROFILE” setting to “NORMAL” manually.
- When the “COLOUR MANAGEMENT” menu is closed, or if the “PROFILE” settings are changed before the adjusted colour settings have been saved, the “PROFILE SAVE” confirmation screen will be displayed. However, if you change the input signals, the adjusted colour settings will not be saved.



# On-screen menus

## Menu screens

The various settings and adjustments for this projector can be carried out by selecting the operations from on-screen menus.

The general arrangement of these menus is shown below.

### Menu screen

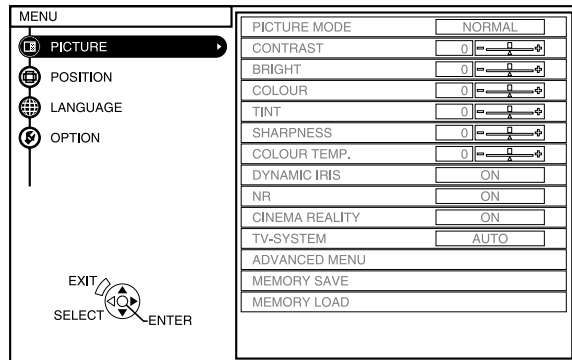

- Press the MENU button to display the menu screen. Refer to page 42 for details on how to operate the on-screen menus.



### POSITION menu (page 48)

When an S-VIDEO/VIDEO/SCART signal is being input

H-POSITION	0
V-POSITION	0
ASPECT	4:3
WSS	ON
KEystone	0

When a YPbPr signal is being input

H-POSITION	0
V-POSITION	0
CLOCK PHASE	0
ASPECT	4:3
WSS	ON
OVER SCAN	ON
KEystone	0

When a HDMI signal is being input

H-POSITION	0
V-POSITION	0
ASPECT	4:3
OVER SCAN	ON
KEystone	0

When a PC signal is being input

H-POSITION	0
V-POSITION	0
DOT CLOCK	0
CLOCK PHASE	0
ASPECT	4:3
KEystone	0
AUTO SETUP	



### LANGUAGE menu (page 50)

1/2
DEUTSCH
FRANÇAIS
ESPAÑOL
ITALIANO
PORTUGUÊS
SVENSKA
NORSK
DANSK

2/2
POLSKI
ČEŠTINA
MAGYAR
РУССКИЙ
ไทย
한국어
ENGLISH
中文



### OPTION menu (page 51)

OSD	ON
OSD DESIGN	TYPE1
OSD POSITION	CENTRE
AUTO SEARCH	ON
BACK COLOUR	BLUE
STARTUP LOGO	ON
DESK/CEILING	DESK
FRONT/REAR	FRONT
OFF TIMER	OFF
FAN CONTROL	NORMAL
LAMP POWER	HIGH
LAMP RUNTIME	5H



### PICTURE menu (page 44)

When an S-VIDEO/VIDEO/SCART signal is being input

PICTURE MODE	NORMAL
CONTRAST	0
BRIGHT	0
COLOUR	0
TINT	0
SHARPNESS	0
COLOUR TEMP.	0
DYNAMIC IRIS	ON
NR	ON
CINEMA REALITY	ON
TV-SYSTEM	AUTO
ADVANCED MENU	
MEMORY SAVE	
MEMORY LOAD	

When a YPbPr/PC/HDMI signal is being input

PICTURE MODE	NORMAL
CONTRAST	0
BRIGHT	0
COLOUR	0
TINT	0
SHARPNESS	0
COLOUR TEMP.	0
DYNAMIC IRIS	ON
NR	ON
CINEMA REALITY	ON
ADVANCED MENU	
MEMORY SAVE	
MEMORY LOAD	
SIGNAL MODE	525p

# Menu operation guide

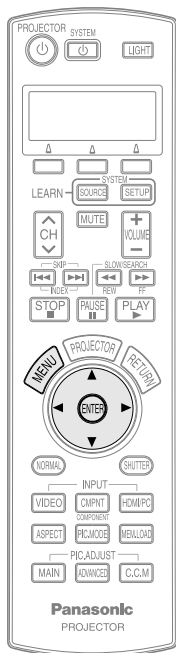

## Projector control panel

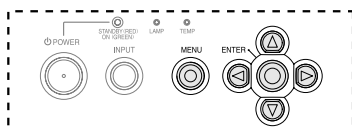

① Press the MENU button.

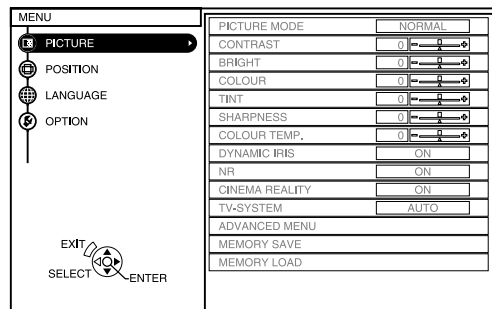

The menu screen will be displayed.

② Press the ▲ or ▼ button to select an item from the main menu on the left side.

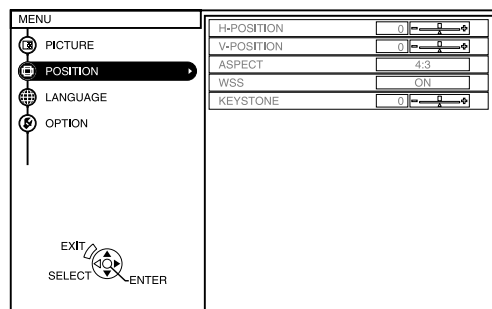

The selected item will be displayed in orange.  
The sub-menu for the selected item will be displayed on the right side.

③ Press the ENTER button.

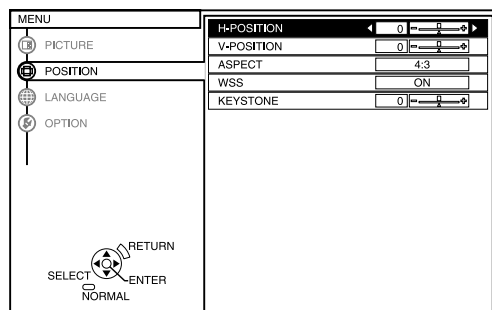

You can select an item from the sub-menu.

### NOTE:

- Press the MENU button or the RETURN button on the remote control unit to return to the previous screen.

④ Press the ▲ or ▼ button to select an item, and then press the ◀ or ▶ button to adjust the value or change the setting.

For items with selective setting or a bar scale, the individual adjustment screen will be displayed as shown below. Press the ▲ or ▼ button to switch the item.

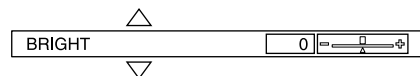

The value and setting indicator will turn light blue when any adjustment changes from the factory set value. For items without any selective setting or bar scale, press the ENTER button. The next screen for the item will then be displayed.

## Returning a setting to the factory default

If you press the NORMAL button on the remote control unit, you can return settings to the factory default settings. However, the operation of this function varies depending on which screen is being displayed.

- When a menu screen is being displayed**  
All the items on the sub-menu which is being displayed will be returned to their factory default settings, and the value and setting indicator will appear white.
- When an individual adjustment screen is being displayed**  
Only the item displayed will be returned to the factory default setting, and the value and setting indicator will appear white.

### NOTE:

- A triangle symbol below a bar scale indicates the factory default setting. Items which do not have this triangle symbol cannot be returned to the factory default setting. The positions of the triangle symbols vary depending on the type of signal being input.

Indicates the current adjustment value

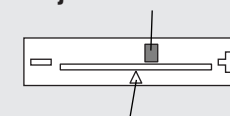

Indicates the standard factory default setting

# Adjusting the picture

- 1 Press the MENU button to display the menu screen.
- 2 Select the "PICTURE" menu from the main menu, and then press the ENTER button.
- 3 Press the ▲ or ▼ button to select an item.
- 4 Press the ◀ or ▶ button to adjust the value or change the setting. For items with selective setting or a bar scale, the individual adjustment screen will be displayed. Press the ▲ or ▼ button to switch the item. For items without any selective setting or bar scale, press the ENTER button. The next screen for the item will then be displayed.

When an S-VIDEO/VIDEO/SCART signal is being input

PICTURE MODE	◀ NORMAL ▶
CONTRAST	0
BRIGHT	0
COLOUR	0
TINT	0
SHARPNESS	0
COLOUR TEMP.	0
DYNAMIC IRIS	ON
NR	ON
CINEMA REALITY	ON
TV-SYSTEM	AUTO
ADVANCED MENU	
MEMORY SAVE	
MEMORY LOAD	

When a YPbPr/PC/HDMI signal is being input

PICTURE MODE	◀ NORMAL ▶
CONTRAST	0
BRIGHT	0
COLOUR	0
TINT	0
SHARPNESS	0
COLOUR TEMP.	0
DYNAMIC IRIS	ON
NR	ON
CINEMA REALITY	ON
ADVANCED MENU	
MEMORY SAVE	
MEMORY LOAD	

SIGNAL MODE 525p

## PICTURE MODE

The picture mode can be selected. Refer to page 33 for details.

## CONTRAST

This adjusts the contrast of the picture. (Adjust the "BRIGHT" setting first if required before adjusting the "CONTRAST" setting.)

The picture is bright: ◀ button  
The picture is dark: ▶ button

## BRIGHT

This adjusts the darker areas (black areas) in the picture.  
Black areas are too light: ◀ button  
Dark areas are too solid: ▶ button

## COLOUR

(S-VIDEO/VIDEO/YPbPr/PC/HDMI only)

The colour is too deep: ◀ button  
The colour is too pale: ▶ button

### NOTE:

- When PC signals are being input, adjustment can be made only when 1 125 (1 080)/60i and 1 125 (1 080)/50i signals are being input.

## TINT

(NTSC/NTSC 4.43/YPbPr/PC/HDMI only)

This adjusts the flesh tones in the picture.

The flesh tones are greenish: ◀ button  
The flesh tones are reddish: ▶ button

### NOTE:

- When PC signals are being input, adjustment can be made only when 1 125 (1 080)/60i and 1 125 (1 080)/50i signals are being input.

## SHARPNESS

To soften the picture details:

◀ button

To sharpen the picture details:

▶ button

## COLOUR TEMP.

White areas are bluish: ◀ button

White areas are reddish: ▶ button

## DYNAMIC IRIS

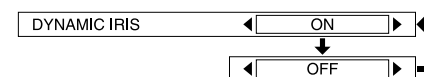

### ON

The amount of light is controlled to project the images with high contrast.

### OFF

"DYNAMIC IRIS" is disabled.

## Noise Reduction (NR)

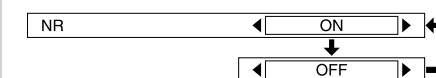

If the signal is of such poor quality that picture interference appears, set "NR" to "ON". To turn off the "NR" feature, set to "OFF".

### NOTE:

- "NR" cannot be set when HDMI signals are being input.

## CINEMA REALITY

[S-VIDEO/VIDEO/PC/HDMI/525i (480i), 625i(576i), 1 125(1 080)/60i and 1 125(1 080)/50i YPbPr only]



### ON

Set to "ON" when you would like 24 frames per second pictures (such as movies) to project the source faithfully.

### OFF

Set to "OFF" when the projected pictures have problems with captions or subtitles when the setting is "ON".

## TV-SYSTEM

(S-VIDEO/VIDEO only)

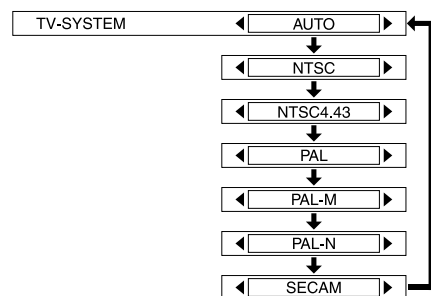

This should normally be set to “AUTO”. If the signal is of such poor quality that the correct format cannot be automatically distinguished, change the setting manually to the required TV system.

### NOTE:

- When set to “AUTO”, the projector automatically distinguishes between NTSC/NTSC 4.43/PAL/PAL60/PAL-M/PAL-N/SECAM signals.

## ADVANCED MENU

Picture settings can be adjusted in more detail.

Press the ENTER button to display the “ADVANCED MENU”

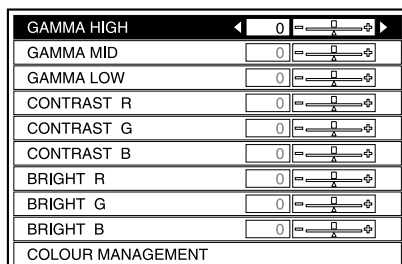

### GAMMA HIGH/MID/LOW

These items are for adjusting the gradation of the bright, medium and dark scenes in the projected image respectively.

### CONTRAST R/G/B

These items are for adjusting the colour temperature of the white areas of the projected image by changing each level.

### BRIGHT R/G/B

These items are for adjusting the colour temperature of the black areas of the projected image by changing each level.

### COLOUR MANAGEMENT

This item is for adjusting the selected colours of the projected image to suit your preference, and saving the settings. Refer to page 36 for details.

## MEMORY SAVE

Press the ENTER button to display the “MEMORY SAVE” menu.

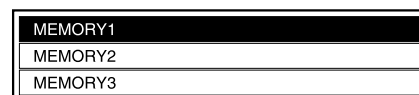

The settings adjusted in “PICTURE” menu can be saved. Press the ▲ or ▼ button to select the number (“MEMORY 1/2/3”) in which you want to save the setting, and then press the ENTER button.

The confirmation screen will then be displayed. Press the ◀ or ▶ button to select “OK” and then press the ENTER button.

The current picture setting will be saved.

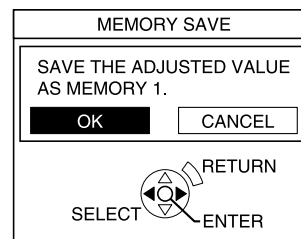

### NOTE:

- You can save up to 3 settings for each of the 2 signal groups described below (up to 6 settings can be saved).

S-VIDEO, VIDEO, YPbPr, SCART, HDMI (except for VGA480 signals) and 1 125 (1 080)/60i and 1 125 (1 080)/50i signals from PCs

VGA480 HDMI signals and PC [except for 1 125 (1 080)/60i and 1 125 (1 080)/50i signals]

## MEMORY LOAD

Press the ENTER button to display the “MEMORY LOAD” menu.

(If any setting is not saved in the “MEMORY SAVE” menu, the “MEMORY LOAD” menu will not be displayed.)

Refer to page 34 on how to retrieve the saved settings.

## SIGNAL MODE

(PC/YPbPr/HDMI only)

This displays the type of signal which is currently being projected.

Refer to the list on page 64 for details on each type of signal.

## Projecting sRGB-compatible pictures

sRGB is an international colour reproduction standard (IEC61966-2-1) established by the International Electrotechnical Commission (IEC). If you would like the colours in sRGB-compatible pictures to be reproduced more faithfully, make the following settings.

- 1 Press the **NORMAL** button when the sub-menu for the “PICTURE” menu is displayed.
- 2 Select “PICTURE MODE” and set it to “NATURAL”.
- 3 Select “LAMP POWER” in the “OPTION” menu and set it to “HIGH”.

# Adjusting the position

- 1 Press the MENU button to display the menu screen.
- 2 Select the "POSITION" menu from the main menu, and then press the ENTER button.
- 3 Press the ▲ or ▼ button to select an item.
- 4 Press the ◀ or ▶ button to adjust the value or change the setting. For items with selective setting or a bar scale, the individual adjustment screen will be displayed. Press the ▲ or ▼ button to switch the item. When the input signal is from a PC, first select "AUTO SETUP" and then press the ENTER button to initiate automatic positioning. If the optimum setting is not obtained when "AUTO SETUP" is carried out, adjust the other items.

When an S-VIDEO/VIDEO/SCART signal is being input

H-POSITION	◀ 0 ▶
V-POSITION	0
ASPECT	4:3
WSS	ON
KEystone	0

When a HDMI signal is being input

H-POSITION	◀ 0 ▶
V-POSITION	0
ASPECT	4:3
OVER SCAN	ON
KEystone	0

When a YPBPR signal is being input

H-POSITION	◀ 0 ▶
V-POSITION	0
CLOCK PHASE	0
ASPECT	4:3
WSS	ON
OVER SCAN	ON
KEystone	0

When a PC signal is being input

H-POSITION	◀ 0 ▶
V-POSITION	0
DOT CLOCK	0
CLOCK PHASE	0
ASPECT	4:3
KEystone	0
AUTO SETUP	

## Horizontal position (H-POSITION)

To move the picture to the left: ◀ button  
To move the picture to the right: ▶ button

## Vertical position (V-POSITION)

To move the picture down: ◀ button  
To move the picture up: ▶ button

## DOT CLOCK

(PC only)  
Periodic striped pattern interference (noise) may occur when a striped pattern such as the one below is projected. If this happens, press the ◀ or ▶ button to adjust so that any such noise is minimised.

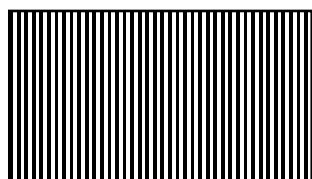

## CLOCK PHASE

(PC/YPBPR only)  
Adjust the "DOT CLOCK" setting first before carrying out this adjustment. Press the ◀ or ▶ button to adjust so that the noise level is least noticeable.

### NOTE:

- If signals with a dot clock frequency of 100 MHz or higher are being input, interference may not be completely eliminated when the "DOT CLOCK" and "CLOCK PHASE" adjustments are carried out.
- When YPBPR signals are being input, "CLOCK PHASE" can be adjusted only when 1 125 (1 080)/60i, 1 125 (1 080)/50i, 1 125 (1 080)/24p, 750 (720)/60p or 750 (720)/50p signals are being input.

## ASPECT

The aspect ratio can be selected. Refer to page 30 for details.

## WSS

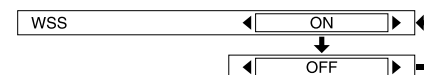

### ON

When the device connected to SCART is turned on, the input select setting will be switched to SCART automatically, and "ASPECT" will also be set automatically. When WSS (Wide Screen Signalling) is detected from PAL or 625i(576i) YPBPR signals, the aspect ratio will also be switched automatically.

### OFF

When SCART signals are being input, the input select setting and "ASPECT" will not be set automatically. WSS will not be detected from PAL or 625i(576i) YPBPR signals.

## OVER SCAN

[525p (480p), 750 (720)/60p, 750 (720)/50p, 1 125 (1 080)/60i, 1 125 (1 080)/50i, 1 125 (1 080)/24p signals for YPBPR and HDMI signals]

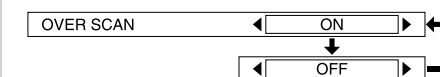

Set to "OFF" when some letters or parts of a projected image not visible around the edges of the image.

## KEystone

When either the projector or the screen is tilted, the keystone distortion will affect the image. If the projected image contains keystone distortion, follow the procedures in the table to correct any keystone distortion. (Vertical keystone distortion correction only.)

Picture condition	Operation
	Press the ▲ button.
	Press the ▼ button.

### NOTE:

- Vertical keystone distortion can be corrected to ±30° of the angle of tilt. However, the greater the correction amount, the more the picture quality will deteriorate, and the harder it will become to achieve a good level of focus. To obtain the best picture quality, set up the projector and screen in such a way that the amount of



# Option settings

- 1 Press the **MENU** button to display the menu screen.
- 2 Select the **“OPTION”** menu from the main menu, and then press the **ENTER** button.
- 3 Press the **▲** or **▼** button to select an item.
- 4 Press the **◀** or **▶** button to change the setting.

OSD	ON
OSD DESIGN	TYPE1
OSD POSITION	CENTRE
AUTO SEARCH	ON
BACK COLOUR	BLUE
STARTUP LOGO	ON
DESK/CEILING	DESK
FRONT/REAR	FRONT
OFF TIMER	OFF
FAN CONTROL	NORMAL
LAMP POWER	HIGH
LAMP RUNTIME	5H

## OSD

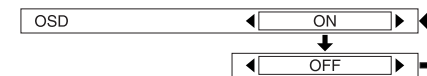

### ON

The signal name is displayed in the top-right corner of the screen when the input signal is changed.

### OFF

Use this setting when you do not want the signal name to be displayed.

#### NOTE:

- The setting for **“TV-SYSTEM”** will also be displayed when an **S-VIDEO/VIDEO** signal is being input.

## OSD DESIGN



You can select the background for the OSD from 3 types.

### TYPE1

Transparent black

### TYPE2

Solid blue

### TYPE3

Transparent navy blue

## OSD POSITION

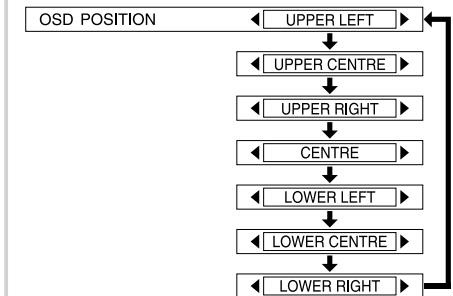

You can select the position where the OSD is displayed.

## AUTO SEARCH

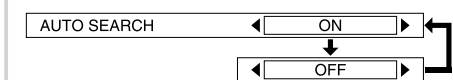

This should normally be set to **“ON”**.

### ON

When the power is turned on, the projector detects which signal is being input, and uses that signal for projection.

### OFF

Use this setting when you do not want the signal source to be changed automatically when the power is turned on.

## AUTO SETUP

(PC only)

**“H-POSITION”**, **“V-POSITION”**, **“DOT CLOCK”** and **“CLOCK PHASE”** are automatically adjusted according to the input signal.

#### NOTE:

- When the **“ASPECT”** is set to **“V SCROLL”** (page 30), **“AUTO SETUP”** cannot be performed.

keystone correction required is as minimal as possible.

- The picture size will also change when correction of keystone distortion is carried out.
- The ratio of length and width of an image may become incorrect depending on the amount of the keystone correction.
- Keystone distortion of the on-screen display will not be corrected.
- Keystone distortion may remain depending on the lens shift adjustment.

# Changing the display language

- 1 Press the **MENU** button to display the menu screen.
- 2 Select the **“LANGUAGE”** menu from the main menu, and then press the **ENTER** button.
- 3 Press the **▲** or **▼** button to select a language, and then press the **ENTER** button.

	1/2
DEUTSCH	
FRANÇAIS	
ESPAÑOL	
ITALIANO	
PORTUGUÊS	
SVENSKA	
NORSK	
DANSK	

	2/2
POLSKI	
ČEŠTINA	
MAGYAR	
РУССКИЙ	
ไทย	
한국어	
ENGLISH	
中文	

Indicates the language which is currently set



## BACK COLOUR



This sets the colour which is projected onto the screen when no signal is being input to the projector.

## STARTUP LOGO



### ON

The “Panasonic” logo will be displayed when the power is turned on.

### OFF

The “Panasonic” logo will not be displayed when the power is turned on.

## DESK/CEILING



This setting should be changed in accordance with the projector setting-up method. (Refer to page 18.)

### DESK

When the projector is placed on a desk or similar.

### CEILING

When the projector is suspended from a ceiling using the ceiling bracket (sold separately).

## FRONT/REAR



This setting should be changed in accordance with the projector setting-up method. (Refer to page 18.)

## FRONT

When the projector is placed in front of a screen.

## REAR

When using a translucent screen.

## OFF TIMER

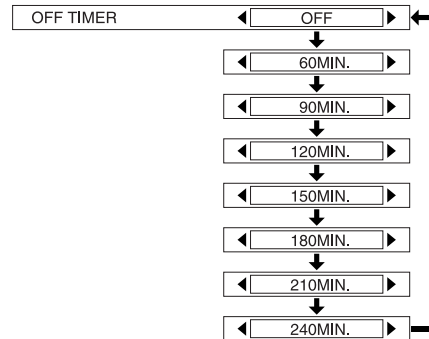

The projector will return to standby mode after the duration of the period you set has passed. The period can be set from 60 minutes to 240 minutes in 30 minute intervals. The remaining time will be displayed 3 minutes before the projector returns to standby mode. The setting will be cancelled if set to “OFF” before reaching the duration of the period you set.

## FAN CONTROL



Set “FAN CONTROL” to “HIGH”, when using this projector at high elevations (above 1 400 m) only.

## LAMP POWER



This setting changes the lamp brightness. When set to “LOW”, the luminance of the lamp is reduced, but the projector uses less power, and the operating noise is also reduced.

The “LOW” setting is recommended for narrow rooms where a high picture luminance is not essential or for watching movies.

### NOTE:

- “LAMP POWER” cannot be set when no signal is being input.

## LAMP RUNTIME

This setting displays the usage time for the lamp unit which is currently being used. When replacing the lamp unit, follow the instructions on page 58, and reset “LAMP RUNTIME” to “0”.

### NOTE:

- The lamp’s operating life varies depending on the usage conditions (such as the “LAMP POWER” setting and the number of times the power is turned on and off).

# When the TEMP indicator and the LAMP indicator are illuminated

There are two indicators on the control panel of the projector which give information about the operating condition of the projector. These indicators illuminate or flash to warn you about problems that have occurred inside the projector, so if you notice that one of the indicators is on, turn off the power and check the table below for the cause of the problem.

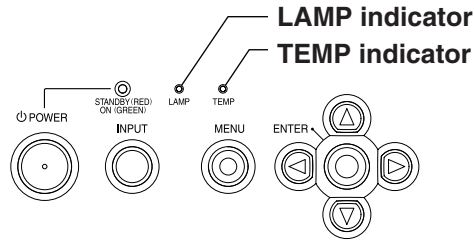

TEMP indicator		
Indicator display	Illuminated (red) (Lamp unit on)	Flashing (red) (Lamp unit off)
Problem	The surrounding temperature or the temperature inside the projector has become unusually high.	The surrounding temperature or the temperature inside the projector has become dangerously high, causing the lamp unit to automatically shut off.
Possible cause	<ul style="list-style-type: none"> <li>• The ventilation holes may be covered.</li> <li>• The ambient temperature in the place of use may be too high.</li> <li>• The air filter may be blocked.</li> </ul>	
Remedy	<ul style="list-style-type: none"> <li>• Uncover the ventilation holes.</li> <li>• Set up the projector in a place where the temperature is between 0 °C (32 °F) and 40 °C (104 °F) and the humidity is between 20% and 80% (with no condensation). [If you set the "FAN CONTROL" to "HIGH" (page 52), set up the projector in a place where the temperature is between 0 °C (32 °F) and 35 °C (95 °F) and the humidity is between 20% and 80% (with no condensation).]</li> <li>• Turn off the MAIN POWER switch by following the procedure on page 28, and then clean the air filter (refer to page 56).</li> </ul>	

LAMP indicator		
Indicator display	Illuminated (red)	Flashing (red)
Problem	It is nearly time to replace the lamp unit.	An abnormality has been detected in the lamp circuit.
Possible cause	<ul style="list-style-type: none"> <li>• Does "REPLACE LAMP" appear on the screen after the projector is turned on?</li> </ul>	<ul style="list-style-type: none"> <li>• The power may have been turned on straight away after it was turned off.</li> <li>• There may be an abnormality in the lamp circuit.</li> </ul>
Remedy	<ul style="list-style-type: none"> <li>• This occurs when the operation time for the lamp unit is nearing 2 700 hours (when "LAMP POWER" has been set to "HIGH" and when "DYNAMIC IRIS" has been set to "ON"). Ask your dealer or an Authorised Service Centre to replace the lamp unit.</li> </ul>	<ul style="list-style-type: none"> <li>• Wait for a while until the lamp unit cools down before turning the power back on again.</li> <li>• Turn off the MAIN POWER switch by following the procedure given on page 28, and then contact an Authorised Service Centre.</li> </ul>

## NOTE:

- Be sure to turn off the MAIN POWER switch by following the procedure given in "Turning off the power" on page 28 before carrying out any of the procedures in the "Remedy" column.
- If the TEMP indicator is illuminated and the power turns off after the procedures in the "Remedy" column have been carried out, it means an abnormality has occurred. Please contact an Authorised Service Centre so that the necessary repairs can be made.

# Cleaning and replacing the air filter

If the air filter becomes clogged with dust, the internal temperature of the projector will rise, the TEMP indicator will illuminate and the projector's power will turn off (the TEMP indicator will flash after the power is turned off).

**The air filter should be cleaned every 100 hours of use.**

- 1 Turn off the MAIN POWER switch and disconnect the mains plug from the mains socket.

Turn off the MAIN POWER switch according to the procedure given in "Turning off the power" on page 28 before disconnecting the mains plug from the mains socket.

- 2 Gently turn the projector upside down.

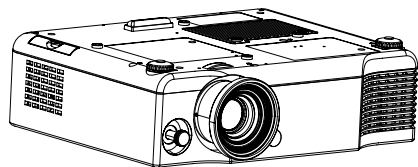

## NOTE:

- Place the projector on top of a soft cloth so that it will not become scratched.

- 3 Remove the air filter.

Put your fingernails under the air filter and pull the air filter out of the projector.

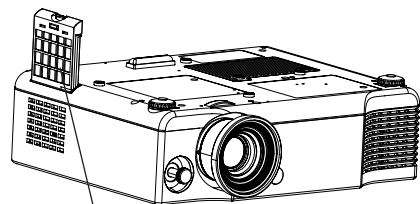

Air filter

- 4 Clean the air filter.

Use a vacuum cleaner to clean off any accumulated dust.

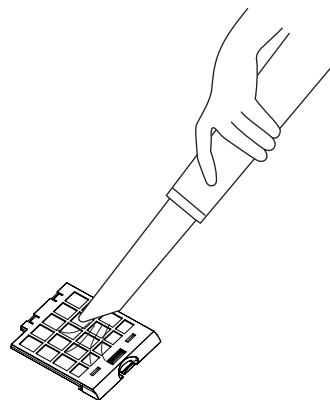

- 5 Install the air filter.

## NOTE:

- Be sure to install the air filter before using the projector. If the projector is used without the air filter installed, dust and other foreign particles will be drawn into the projector, and malfunctions will result.
- If the dust cannot be removed by cleaning, it is time to replace the air filter. Please consult your dealer. Furthermore, if the lamp unit is being replaced, replace the air filter at this time also.

# Replacing the lamp unit

## Warning

**When replacing the lamp, allow it to cool for at least one hour before handling it.**

- The lamp cover gets very hot, and touching it can cause burns.

## Notes on replacing the lamp unit

- The light generating lamp is made of glass, so dropping it or allowing it to hit hard objects may cause it to burst. Be careful when handling the lamp.
- Dispose of the removed old lamp with the same care that would be taken with a fluorescent light.
- A Phillips screwdriver is necessary for removing the lamp unit.

## NOTE:

- The projector is not supplied with a replacement lamp unit. Please ask your dealer for details. Lamp unit product no.: **ET-LAE900**

## CAUTION:

- Do not use any lamp unit other than the one with the product number indicated above.

## Lamp unit replacement period



The lamp is a consumable product. Even when the full life of the bulb has not been exhausted, the brightness of the light will gradually decline. Therefore periodic replacement of the lamp is necessary.

The intended lamp replacement interval is 3 000 hours, but it is possible that the lamp may need to be replaced earlier due to variables such as a particular lamp's characteristics, usage conditions and the installation environment. Early preparation for lamp replacement is encouraged.

The lamp will automatically shut off after approximately 30 minutes when 3 000 hours of use have been reached because of a much greater chance of it exploding after this time.

## NOTE:

- The usage hours explained above are for when "LAMP POWER" in the "OPTION" menu has been set to "HIGH" and when "DYNAMIC IRIS" in the "PICTURE" menu has been set to "ON". When "LAMP POWER" has been set to "HIGH" and "DYNAMIC IRIS" has been set to "OFF", the usage hours will be 2 000 hours. If "LAMP POWER" is set to "LOW", the brightness of the lamp will be less and life of the lamp can be extended.
- While 3 000 hours is the intended replacement interval, it is not a period of time covered by warranty.

	On-screen display 	LAMP indicator 
More than 2 700 hours*	Displayed for 30 seconds. Pressing any button will clear the display.	Illuminates red during image projection and standby mode.
More than 3 000 hours*	Remains displayed until any button is pressed.	

\* These periods of time may become shorter according to the settings of the projector.

## Lamp unit replacement procedure

### NOTE:

- If the lamp usage time has passed 3 000 hours (when “LAMP POWER” has been set to “HIGH” and when “DYNAMIC IRIS” has been set to “ON”), the projector will switch to standby mode after approximately 30 minutes of operation. The steps ⑦ to ⑪ on the next page should thus be completed within 30 minutes.

- ① Turn off the MAIN POWER switch according to the procedure given in “Turning off the power” on page 28, and then disconnect the mains plug from the mains socket and check that the area around the lamp unit has cooled down.
- ② Use a Phillips screwdriver to turn the lamp unit cover fixing screws at the bottom of the projector, and then remove the lamp unit cover.

Lamp unit cover

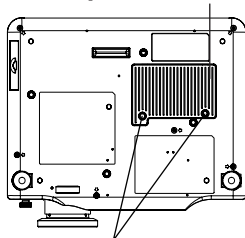

Lamp unit cover fixing screws

- ③ Use a Phillips screwdriver to loosen the two lamp unit fixing screws until the screws turn freely. Then hold the handle of the lamp unit and gently pull it out from the projector.

Lamp unit fixing screws

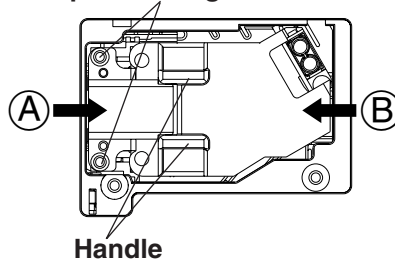

- ④ Insert the new lamp unit while making sure that the direction of insertion is correct, and then use a Phillips screwdriver to securely tighten the lamp unit fixing screws.

When inserting the new lamp unit, be sure to push it in at the point ① and ②.

- ⑤ Install the lamp unit cover, and then use a Phillips screwdriver to securely tighten the lamp unit cover fixing screws.
- ⑥ Insert the mains plug into the mains socket and then press the MAIN POWER switch.
- ⑦ Press the POWER button so that a picture is projected onto the screen.
- ⑧ Press the MENU button to display the menu screen, and then press the ▲ or ▼ button to select the “OPTION” menu.

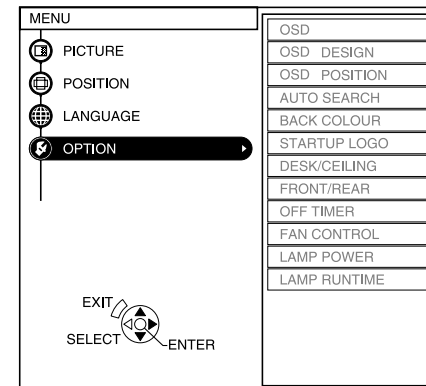

- ⑨ Press the ENTER button, and then press the ▲ or ▼ button to select “LAMP RUNTIME”.

OSD	ON
OSD DESIGN	TYPE1
OSD POSITION	CENTRE
AUTO SEARCH	ON
BACK COLOUR	BLUE
STARTUP LOGO	ON
DESK/CEILING	DESK
FRONT/REAR	FRONT
OFF TIMER	OFF
FAN CONTROL	NORMAL
LAMP POWER	HIGH
LAMP RUNTIME	2720H

- ⑩ Press and hold the ENTER button for approximately 3 seconds.

OSD	ON
OSD DESIGN	TYPE1
OSD POSITION	CENTRE
AUTO SEARCH	ON
BACK COLOUR	BLUE
STARTUP LOGO	ON
DESK/CEILING	DESK
FRONT/REAR	FRONT
OFF TIMER	OFF
FAN CONTROL	NORMAL
LAMP POWER	HIGH
TIME RESET	[POWER OFF]

The “LAMP RUNTIME” will change to “TIME RESET [POWER OFF]”.

- If the MENU button or the RETURN button on the remote control unit is pressed, the lamp time resetting screen will be cancelled.
- ⑪ Turn off the power.  
This will reset the cumulative usage time for the lamp unit to zero.  
Refer to page 28 for details on how to turn off the power.

### NOTE:

- Be sure to install the lamp unit and the lamp unit cover securely. If they are not securely installed, it may cause the protection circuit to operate so that the power cannot be turned on.

# Before calling for service

Before calling for service, check the following points.

Problem	Possible cause	Page
<b>Power does not turn on.</b>	● The mains lead may not be connected.	–
	● The MAIN POWER switch is turned off.	–
	● The main power supply is not being supplied to the mains socket.	–
	● TEMP indicator is illuminated or flashing.	54
	● LAMP indicator is illuminated or flashing.	55
<b>No picture appears.</b>	● The lamp unit cover has not been securely installed.	–
	● The video signal input source may not be connected properly.	–
	● The input selection setting may not be correct.	27
	● The “BRIGHT” adjustment setting may be at the minimum possible setting.	44
<b>The picture is fuzzy.</b>	● The “SHUTTER” function may be in use.	34
	● The lens cover may still be attached to the lens.	–
	● The lens focus may not have been set correctly.	27
	● The projector may not be at the correct distance from the screen.	19
<b>The colour is pale or grayish.</b>	● The lens may be dirty.	–
	● The projector may be tilted too much.	17
	● “COLOUR” or “TINT” adjustment may be incorrect.	44, 45
<b>The remote control unit does not operate.</b>	● The input source which is connected to the projector may not be adjusted correctly.	–
	● The batteries may be weak.	–
<b>The picture does not display correctly.</b>	● The batteries may not be inserted correctly.	25
	● The remote control signal receptor on the projector may be obstructed.	25
	● The remote control unit may be out of the operation range.	25
	● The signal format (“TV-SYSTEM”) may not be set correctly.	46
	● There may be a problem with the video tape or other signal source.	–
	● A signal which is not compatible with the projector may be being input.	64

Problem	Possible cause	Page
<b>Picture from computer does not appear.</b>	● The cable may be too long.	–
	● The external video output for the laptop computer may not be set correctly. (You may be able to change the external output settings by pressing the [Fn]+[F3] or [Fn]+[F10] keys simultaneously. The actual method varies depending on the type of computer, so refer to the documentation provided with your computer for further details.)	–

## Cleaning and maintenance

**Before carrying out cleaning and maintenance, be sure to disconnect the mains plug from the mains socket.**

**Wipe the cabinet with a soft, dry cloth.**

If the cabinet is particularly dirty, soak the cloth in water with a small amount of neutral detergent in it, squeeze the cloth very well, and then wipe the cabinet. After cleaning, wipe the cabinet dry with a dry cloth. If using a chemically-treated cloth, read the instructions supplied with the cloth before use.

**Do not wipe the lens with a cloth that is dusty or which produces lint.**

If any dust or lint gets onto the lens, such dust or lint will be magnified and projected onto the screen. Use a blower to clean any dust and lint from the lens surface, or use a soft cloth to wipe off any dust or lint.



# Specifications

Power supply:	100 V - 240 V ~, 50 Hz/60 Hz
Power consumption:	180 W [During standby (when fan is stopped): Approx. 0.07 W]
Amps:	2.2 A - 1.1 A
LCD panel:	
Panel size (diagonal):	0.7 type (17.78 mm)
Aspect ratio:	16:9
Display method:	3 transparent LCD panels (RGB)
Drive method:	Active matrix method
Pixels:	921 600 (1 280 x 720) x 3 panels
Lens:	Manual zoom (1 - 2.0) / Manual focus F 1.9 - 3.1, f 21.7 mm - 43.1 mm
Lamp:	UHM lamp (130 W)
Luminosity:	1 000 lm
Scanning frequency(for RGB signals):	
Horizontal scanning frequency:	30 kHz - 70 kHz
Vertical scanning frequency:	50 Hz - 87 Hz
Dot clock frequency:	Less than 100 MHz
YPbPr signals:	525i (480i), 525p (480p), 625i (576i), 625p (576p), 1 125 (1 080)/60i, 1 125 (1 080)/50i, 1 125 (1 080)/24p, 750 (720)/60p, 750 (720)/50p
Colour system:	7 (NTSC/NTSC 4.43/PAL/PAL-M/PAL-N/ PAL60/SECAM)
Projection size:	1 016 mm - 5 080 mm (40" - 200")
Throw distance:	1.2 m - 12.4 m (3'11" - 40'8")
Screen aspect ratio:	16:9
Installation:	Front/Rear/Ceiling/Desk (Menu selection method)
Connectors	
S-VIDEO IN:	Single-line, Mini DIN 4-pin Y: 1.0 V [p-p], C: 0.286 V [p-p], 75 Ω
VIDEO IN:	Single-line, RCA pin jack 1.0 V [p-p], 75 Ω
PC IN:	
RGB:	Single-line, D-sub HD 15-pin (female)
R.G.B.:	0.7 V [p-p], 75 Ω
G.SYNC:	1.0 V [p-p], 75 Ω
HD/SYNC:	TTL high impedance, automatic positive/negative polarity compatible
VD:	TTL high impedance, automatic positive/negative polarity compatible

COMPONENT IN:	
Y, Pb/Cb, Pr/Cr	Single-line, RCA pin jack x 3
Y:	1.0 V [p-p] (Including sync), 75 Ω
Pb,Pr (Cb,Cr):	0.7 V [p-p], 75 Ω
HDMI IN:	Single-line, 19-pin HDMI connector
SCART in:	Single-line, 21-pin SCART connector
S-VIDEO:	Y: 1.0 V [p-p], C: 0.286 V [p-p], 75 Ω
VIDEO:	1.0 V [p-p], 75 Ω
RGB:	R.G.B.: 0.7 V [p-p], 75 Ω SYNC.: 0.3 V [p-p], 75 Ω
SERIAL:	DIN 8-pin RS-232C compatible
Cabinet:	Moulded plastic (ABS/PC)
Dimensions:	
Width:	335 mm (13-3/16")
Height:	104 mm (4-3/32")
Length:	270 mm (10-5/8") (Not including lens)
Weight:	3.6 kg (7.9 lbs.)
Operating environment:	
Temperature:	0 °C - 40 °C (32 °F - 104 °F) [When the "FAN CONTROL" is set to "HIGH" (page 52): 0 °C - 35 °C (32 °F - 95 °F)]
Humidity:	20% - 80% (no condensation)
Certifications:	EN60950, EN55022, EN61000-3-2, EN61000-3-3, EN55024
<b>&lt;Remote control unit&gt;</b>	
Power supply:	3 V DC (AA battery x2)
Operating range:	Approx. 7 m (23') (when operated directly in front of signal receptor)
Weight:	70 g (2.5 ozs.) (including batteries)
Dimensions:	
Width:	52 mm (2-1/32")
Length:	200 mm (7-27/32")
Height:	28.5 mm (1-3/32") (Not including the projection parts)
<b>&lt;Options&gt;</b>	
Ceiling bracket	ET-PKE700
Ceiling bracket (for low ceilings)	ET-PKE300
Projection screen	ET-SRW90CT
Serial adapter (DIN 8-pin/D-sub 9-pin)	ET-ADSER







(Continued from previous page.)

VS1	Aspect ratio selection	The aspect ratio will be switched each time the command is sent. (page 30)
OST	Returning to the default setting	Use this command to return the setting to the factory default.

### Inquiry commands

Command	Contents	Parameter	
QPW	Power condition	000=OFF	001=ON
QIN	Input signal	VID=VIDEO RG1=PC SCT=SCART	SVD=S-VIDEO YUV=YPbPr HDM=HDMI
QPM	Picture mode	NAT=NATURAL DYN=DYNAMIC CN2=CINEMA2 VID=VIDEO	NOR=NORMAL CN1=CINEMA1 CN3=CINEMA3
QSH	Shutter function	0=OFF	1=ON
QFZ	Freeze function	0=OFF	1=ON

### Cable specifications

(When connected to a personal computer)

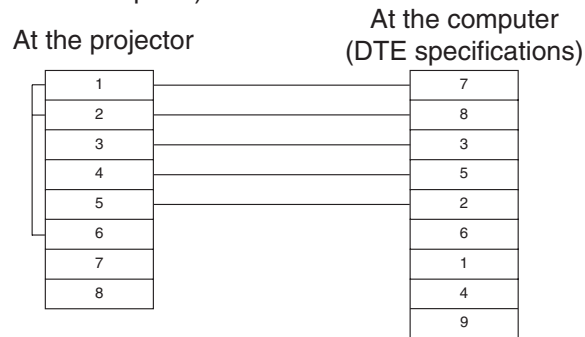

### Projection dimensions calculation methods

Dimensions such as projection distances can be calculated from the screen diagonal length. (Units for calculations: m)

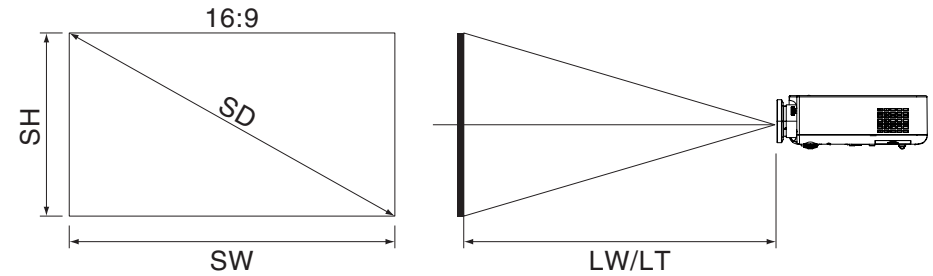

Screen Width:  $SW=SD \times 0.872$

Screen Height:  $SH=SD \times 0.490$

Minimum Projection Distance:  $LW=1.2244 \times SD - 0.056$

Maximum Projection Distance:  $LT=2.4449 \times SD - 0.056$

\*The values obtained from the formulas above are approximate.

### Dimensions

<Units: mm (inch)>

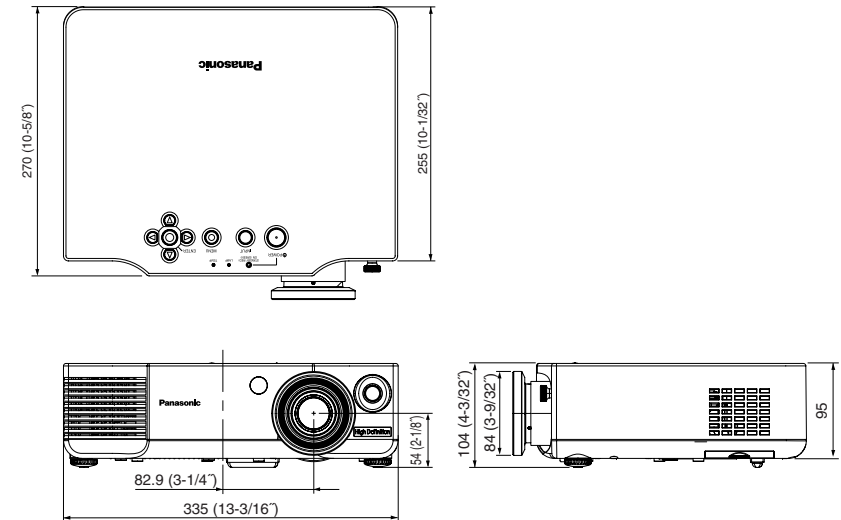

# Trademark acknowledgements

- VGA and XGA are trademarks of International Business Machines Corporation.
- S-VGA is a registered trademark of the Video Electronics Standards Association.
- HDMI, the HDMI logo and High-Definition Multimedia Interface are trademarks or registered trademarks of HDMI Licensing LLC.

All other trademarks are the property of the various trademark owners.

## Information on Disposal for Users of Waste Electrical & Electronic Equipment (private households)



This symbol on the products and/or accompanying documents means that used electrical and electronic products should not be mixed with general household waste.

For proper treatment, recovery and recycling, please take these products to designated collection points, where they will be accepted on a free of charge basis. Alternatively, in some

countries you may be able to return your products to your local retailer upon the purchase of an equivalent new product.

Disposing of this product correctly will help to save valuable resources and prevent any potential negative effects on human health and the environment which could otherwise arise from inappropriate waste handling. Please contact your local authority for further details of your nearest designated collection point.

Penalties may be applicable for incorrect disposal of this waste, in accordance with national legislation.

### For business users in the European Union

If you wish to discard electrical and electronic equipment, please contact your dealer or supplier for further information.

### Information on Disposal in other Countries outside the European Union

This symbol is only valid in the European Union.

If you wish to discard this product, please contact your local authorities or dealer and ask for the correct method of disposal.

---

**Matsushita Electric Industrial Co., Ltd.**

Web Site: <http://www.panasonic.co.jp/global/>

These Operating Instructions are printed on recycled paper.