

Before using the projector, please read this operation manual carefully.

OPERATION MANUAL

ENGLISH

IMPORTANT

For your assistance in reporting the loss or theft of your Projector, please record the Serial Number located on the bottom of the projector and retain this information. Before recycling the packaging, please be sure that you have checked the contents of the carton thoroughly against the list of "Supplied Accessories" on page 12.

Model No.: XV-Z9000U

Serial No.:

There are two important reasons for prompt warranty registration of your new SHARP Projector, using the REGISTRATION CARD packed with the projector.

1. WARRANTY

This is to assure that you immediately receive the full benefit of the parts, service and labor warranty applicable to your purchase.





2. CONSUMER PRODUCT SAFETY ACT

To ensure that you will promptly receive any safety notification of inspection, modification, or recall that SHARP may be required to give under the 1972 Consumer Product Safety Act, PLEASE READ CAREFULLY THE IMPORTANT "LIMITED WARRANTY" CLAUSE.

U.S.A. ONLY

WARNING: High brightness light source. Do not stare into the beam of light, or view directly. Be especially careful that children do not stare directly into the beam of light.

WARNING: To reduce the risk of fire or electric shock, do not expose this product to rain or moisture.

| | | |
|--|---|--|
|  <div style="text-align: center;"> <p>CAUTION</p> <p>RISK OF ELECTRIC SHOCK. DO NOT REMOVE SCREWS EXCEPT SPECIFIED USER SERVICE SCREW.</p> </div>  |  | <p>The lightning flash with arrowhead symbol, within an equilateral triangle, is intended to alert the user to the presence of uninsulated "dangerous voltage" within the product's enclosure that may be of sufficient magnitude to constitute a risk or electric shock to persons.</p> |
| <p>CAUTION: TO REDUCE THE RISK OF ELECTRIC SHOCK, DO NOT REMOVE COVER. NO USER-SERVICEABLE PARTS EXCEPT LAMP UNIT. REFER SERVICING TO QUALIFIED SERVICE PERSONNEL.</p> |  | <p>The exclamation point within a triangle is intended to alert the user to the presence of important operating and maintenance (servicing) instructions in the literature accompanying the product.</p> |

WARNING: FCC Regulations state that any unauthorized changes or modifications to this equipment not expressly approved by the manufacturer could void the user's authority to operate this equipment.

U.S.A. ONLY

PRODUCT DISPOSAL

This product utilizes tin-lead solder, and high intensity discharge lamp (HID lamp) containing a small amount of mercury. Disposal of these materials may be regulated due to environmental considerations. For disposal or recycling information, please contact your local authorities or the Electronic Industries Alliance: www.eiae.org.

INFORMATION

This equipment has been tested and found to comply with the limits for a Class B digital device, pursuant to Part 15 of the FCC Rules. These limits are designed to provide reasonable protection against harmful interference in a residential installation. This equipment generates, uses, and can radiate radio frequency energy and, if not installed and used in accordance with the operation manual, may cause harmful interference to radio communications. However, there is no guarantee that interference will not occur in a particular installation. If this equipment does cause harmful interference to radio or television reception, which can be determined by turning the equipment off and on, the user is encouraged to try to correct the interference by one or more of the following measures:

- Reorient or relocate the receiving antenna.
- Increase the separation between the equipment and the receiver.
- Connect the equipment into an outlet on a circuit different from that to which the receiver is connected.
- Consult the dealer or an experienced radio/TV technician for help.

U.S.A. ONLY

Declaration of Conformity

SHARP PROJECTOR, MODEL XV-Z9000U

This device complies with Part 15 of the FCC rules. Operation is subject to the following conditions: (1) This device may not cause harmful interference, and (2) this device must accept any interference received, including interference that may cause undesired operation.

Responsible Party:

SHARP ELECTRONICS CORPORATION
 Sharp Plaza, Mahwah, New Jersey 07430
 TEL: 1-800-BE-SHARP (1-800-237-4277)

U.S.A. ONLY

WARNING:

The cooling fan in this projector continues to run for about 90 seconds after the projector is turned off. During normal operation, when turning the power off always use the **OFF** button on the projector or on the remote control. Ensure the cooling fan has stopped before disconnecting the power cord.
DURING NORMAL OPERATION, NEVER TURN THE PROJECTOR OFF BY DISCONNECTING THE POWER CORD. FAILURE TO OBSERVE THIS WILL RESULT IN PREMATURE LAMP FAILURE.

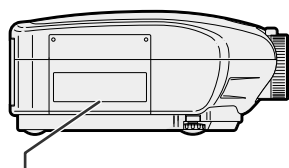

Caution Concerning the Lamp Replacement

There is potential glass particles hazard if the lamp ruptures.



USER SERVICE SCREWS
 VIS POUR ENTRETIEN PAR L'UTILISATEUR



LAMP REPLACEMENT CAUTION

BEFORE REMOVING THE SCREW, DISCONNECT POWER CORD. HOT SURFACE INSIDE.
 ALLOW 1 HOUR TO COOL BEFORE REPLACING THE LAMP. REPLACE WITH SAME SHARP LAMP UNIT TYPE BQC-XVZ9000/1 ONLY.
 UV RADIATION : CAN CAUSE EYE DAMAGE.
 TURN OFF LAMP BEFORE SERVICING.
 MEDIUM PRESSURE LAMP : RISK OF EXPLOSION.
 POTENTIAL HAZARD OF GLASS PARTICLES IF LAMP HAS RUPTURED. HANDLE WITH CARE.
 SEE OPERATION MANUAL.



PRECAUTIONS A OBSERVER LORS DU REMPLACEMENT DE LA LAMPE.

DEBRANCHER LE CORDON D'ALIMENTATION AVANT DE RETIRER LES VIS. L'INTERIEUR DU BOITIER ETANT EXTREMEMENT CHAUD, ATTENDRE 1 HEURE AVANT DE PROCEDER AU REMPLACEMENT DE LA LAMPE.
 NE REMPLACER QUE PAR UNE LAMPE SHARP DE TYPE BQC-XVZ9000/1.
 RAYONS ULTRAVIOLETS : PEUVENT ENDOMMAGER LES YEUX.
 ETEINDRE LA LAMPE AVANT DE PROCEDER A L'ENTRETIEN.
 LAMPE A MOYENNE PRESSION : RISQUE D'EXPLOSION. DANGER POTENTIEL DE PARTICULES DE VERRE EN CAS D'ECLATEMENT DE LA LAMPE.
 A MANIPULER AVEC PRECAUTION, SE REPORTER AU MODE D'EMPLOI.

WARNING:

Some IC chips in this product include confidential and/or trade secret property belonging to Texas Instruments. Therefore you may not copy, modify, adapt, translate, distribute, reverse engineer, reverse assemble or discompile the contents thereof.



IMPORTANT SAFEGUARDS

Electrical energy can perform many useful functions. This product has been engineered and manufactured to ensure your personal safety. However IMPROPER USE CAN RESULT IN POTENTIAL ELECTRICAL SHOCK OR FIRE HAZARD. In order not to defeat the safeguards incorporated into this Projector, observe the following basic rules for its installation, use and servicing. For your own protection and reliable usage of your Projector, please be sure to read these “IMPORTANT SAFEGUARDS” carefully before use.

1. Read Instructions

All the safety and operating instructions should be read before the product is operated.

2. Retain Instructions

The safety and operating instructions should be retained for future reference.

3. Heed Warnings

All warnings on the product and in the operating instructions should be adhered to.

4. Follow Instructions

All operating and use instructions should be followed.

5. Cleaning

Unplug this product from the wall outlet before cleaning. Do not use liquid cleaners or aerosol cleaners. Use a damp cloth for cleaning.

6. Attachments

Do not use attachments not recommended by the product manufacturer as they may cause hazards.

7. Water and Moisture

Do not use this product near water – for example, near a bathtub, wash bowl, kitchen sink, or laundry tub; in a wet basement; or near a swimming pool; and the like.

8. Accessories

Do not place this product on an unstable cart, stand, tripod, bracket, or table. The product may fall, causing serious injury to a child or adult, and serious damage to the product. Use only with a cart, stand, tripod, bracket, or table recommended by the manufacturer, or sold with the product. Any mounting of the product should follow the manufacturer's instructions, and should use a mounting accessory recommended by the manufacturer.

9. Transportation

A product and cart combination should be moved with care. Quick stops, excessive force, and uneven surfaces may cause the product and cart combination to overturn.



10. Ventilation

Slots and openings in the cabinet are provided for ventilation to ensure reliable operation of the product and to protect it from overheating. The openings should never be covered or blocked by placing the product on a bed, sofa, rug, or other similar surface. This product should not be placed in a built-in installation such as a bookcase or rack unless proper ventilation is provided or the manufacturer's instructions have been adhered to.

11. Power Sources

This product should be operated only from the type of power source indicated on the marking label. If you are not sure of the type of power supply to your home, consult your product dealer or local power company. For products intended to operate from battery power, or other sources, refer to the operating instructions.

12. Grounding or Polarization

This product is equipped with a three-wire grounding-type plug, a plug having a third (grounding) pin. This plug will only fit into a grounding-type power outlet. This is a safety feature. If you are unable to insert the plug into the outlet, contact your electrician to replace your obsolete outlet. Do not defeat the safety purpose of the grounding-type plug.

13. Power-Cord Protection

Power-supply cords should be routed so that they are not likely to be walked on or pinched by items placed upon or against them, paying particular attention to cords at plugs, convenience receptacles, and the point where they exit from the product.

14. Lightning

For added protection for this product during a lightning storm, or when it is left unattended and unused for long periods of time, unplug it from the wall outlet and disconnect the power cord. This will prevent damage to the product due to lightning and power-line surges.

15. Overloading

Do not overload wall outlets, extension cords, or integral convenience receptacles as this can result in a risk of fire or electric shock.

16. Object and Liquid Entry

Never push objects of any kind into this product through openings as they may touch dangerous voltage points or short-out parts that could result in a fire or electric shock. Never spill liquid of any kind on the product.

17. Servicing

Do not attempt to service this product yourself as opening or removing covers may expose you to dangerous voltage or other hazards. Refer all servicing to qualified service personnel.

18. Damage Requiring Service

Unplug this product from the wall outlet and refer servicing to qualified service personnel under the following conditions:

- a. If the power-supply cord or plug is damaged.
- b. If liquid has been spilled, or objects have fallen into the product.
- c. If the product has been exposed to rain or water.
- d. If the product does not operate normally by following the operating instructions. Adjust only those controls that are covered by the operating instructions, as an improper adjustment of other controls may result in damage and will often require extensive work by a qualified technician to restore the product to normal operation.
- e. If the product has been dropped or damaged in any way.
- f. If the product exhibits a distinct change in performance, this indicates a need for service.

19. Replacement Parts

When replacement parts are required, be sure the service technician has used replacement parts specified by the manufacturer or with the same characteristics as the original part. Unauthorized substitutions may result in fire, electric shock, or other hazards.

20. Safety Check

Upon completion of any service or repairs to this product, ask the service technician to perform safety checks to determine that the product is in proper operating condition.

21. Wall or Ceiling Mounting

This product should be mounted to a wall or ceiling only as recommended by the manufacturer.

22. Heat

This product should be situated away from heat sources such as radiators, heat registers, stoves, or other products (including amplifiers) that produce heat.



IMPORTANT SAFEGUARDS



Caution Concerning the Lamp Unit

There is a potential hazard of glass particles if the lamp ruptures. In case of lamp rupture, contact your nearest Authorized SharpVision Service Center or Dealer for a replacement. See "Replacing the Lamp" on page 47.

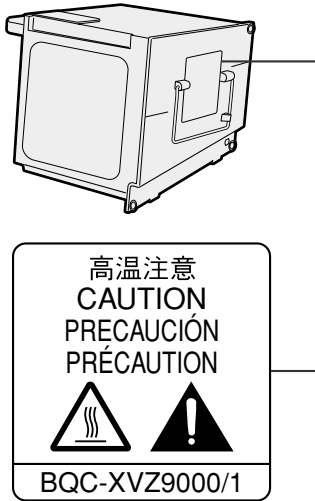

This label is pasted the side of the projector.

| | |
|--|--|
| USER SERVICE SCREWS VIS POUR ENTRETIEN PAR L'UTILISATEUR | |
| LAMP REPLACEMENT CAUTION BEFORE REMOVING THE SCREW, DISCONNECT POWER CORD. HOT SURFACE INSIDE. ALLOW 1 HOUR TO COOL BEFORE REPLACING THE LAMP. REPLACE WITH SAME SHARP LAMP UNIT TYPE BQC-XVZ9000/1 ONLY. UV RADIATION : CAN CAUSE EYE DAMAGE. TURN OFF LAMP BEFORE SERVICING. MEDIUM PRESSURE LAMP : RISK OF EXPLOSION. POTENTIAL HAZARD OF GLASS PARTICLES IF LAMP HAS RUPTURED. HANDLE WITH CARE. SEE OPERATION MANUAL. | PRECAUTIONS A OBSERVER LORS DU REMPLACEMENT DE LA LAMPE. DEBRANCHER LE CORDON D'ALIMENTATION AVANT DE RETIRER LES VIS. L'INTERIEUR DU BOITIER ETANT EXTREMEMENT CHAUD, ATTENDRE 1 HEURE AVANT DE PROCEDER AU REMPLACEMENT DE LA LAMPE. NE REMPLACER QUE PAR UNE LAMPE SHARP DE TYPE BQC-XVZ9000/1. RAYONS ULTRAVIOLETS : PEUVENT ENDOMMAGER LES YEUX. ETEINDRE LA LAMPE AVANT DE PROCEDER A L'ENTRETIEN. LAMPE A MOYENNE PRESSION : RISQUE D'EXPLOSION. DANGER POTENTIEL DE PARTICULES DE VERRE EN CAS D'ECLATEMENT DE LA LAMPE. A MANIPULER AVEC PRECAUTION, SE REPORTER AU MODE D'EMPLOI. |

Cautions Concerning the Setup of the Projector

For minimal servicing and to maintain high image quality, SHARP recommends that this projector be installed in an area free from humidity, dust and cigarette smoke. When the projector is subjected to these environments, the lens and part of filter must be cleaned more often than usual. As long as the projector is properly maintained in this manner, use in these environments will not reduce the overall operation life. Please note that all internal cleaning must be performed by an Authorized SharpVision Service Center or Dealer.

- Do not expose the projector to extreme heat or cold.
 Operating temperature: 41°F to 95°F (+5°C to 35°C)
 Storage temperature: -4°F to 140°F (-20°C to +60°C)

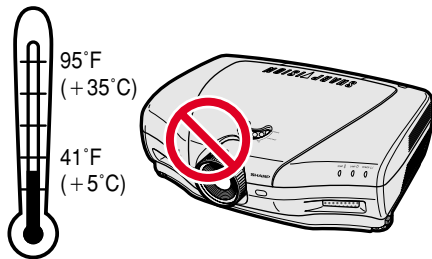

Notes on Operation

- The exhaust ventilative hole, the lamp cage cover and adjacent areas may get extremely hot during projector operation. To prevent injury, do not touch these areas until they have sufficiently cooled down.
- Allow at least 1 foot (30 cm) of space between the exhaust ventilative hole and the nearest wall or obstruction.
- If the cooling fan becomes obstructed, a protection device will automatically turn off the projector lamp. This does not indicate a malfunction. Remove the projector power cord from the wall outlet and wait at least 10 minutes. Then turn on the power by plugging the power cord back in. This will return the projector to the normal operating condition.

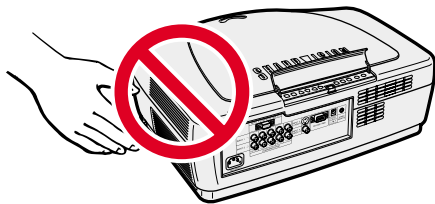



IMPORTANT SAFEGUARDS



Temperature Monitor Function

If the projector starts to overheat due to setup problems or a dirty air filter, “TEMP.” and “” will flash in the lower-left corner of the picture. If the temperature continues to rise, the lamp will turn off, the TEMPERATURE WARNING indicator on the projector will flash, and after a 90-second cooling-off period the power will shut off. Refer to “Lamp/Maintenance Indicators” on page 45, for details.

NOTE

- The cooling fan regulates the internal temperature, and its performance is automatically controlled. The sound of the fan may change during projector operation due to changes in the fan speed.



Lamp Monitor Function

When the projector is turned on after the lamp has been used for 1,900 hours, “LAMP” and “” will flash in the lower-left corner of the picture to advise you to replace the lamp. See page 47 for lamp replacement. If the lamp has been used for 2,000 hours, the projector power will automatically turn off and the projector will enter standby mode. Refer to “Lamp/Maintenance Indicators” on page 45, for details.

Using the Terminal Cover

- When ceiling-mounting the projector, attach the terminal cover (supplied) to hide the connecting cables.
- Use the terminal cover to hide the connecting cables when the projector is used on a desktop or high mounted.

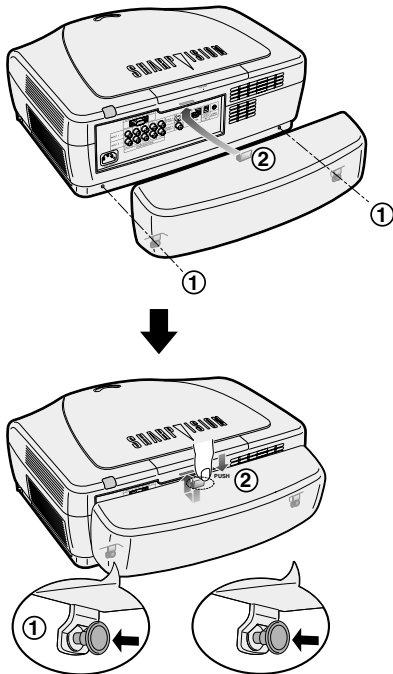

- ① Install the terminal cover using the two attached clips.
- ② Attach the terminal cover by aligning with the tab on the projector.



Outstanding Features



1. **Wide DMD™* (Digital Micromirror Device) Chip**

The DMD Chip allows for a higher contrast image. Also, as it has an aspect ratio of 16:9, it is possible to view, in the best possible picture frame, software recorded on 16:9 from DVD or DTV.

* Digital Light Processing, DLP, Digital Micromirror Device and DMD are trademarks of Texas Instruments.

2. **Full 720P Resolution**

The high resolution panel of 921,600 pixels (1280 × 720 dots) allows for viewing high image quality just as the original as well as HDTV 720P signals.

3. **Low Noise Design**

A new optical engine has been developed for this product resulting in minimized fan noise for undisturbed viewing.

4. **For Use with DTV**

Allows projection of DTV images and 16:9 wide-screen images when connected to a DTV decoder or similar video system.

5. **New Progressive Mode and Film Mode**

Optimizes the image by converting the interlaced signal to the progressive. Useful for displaying slow-moving images or still images. Three modes are available.

6. **Advanced Video Circuitry**

Provides high quality images with minimal dot crawl and cross color noise.

7. **Easy-to-use Graphical User Interface (GUI)**

A multi-color menu system, which allows for simple image adjustments.

8. **Color Temperature Adjustment**

The function can be used to adjust the color temperature to suit the type of image input to the projector.

9. **Gamma Correction Function**

The gamma value setting can be adjusted according to the input source for optimal image contrast.

10. **Brightness Switchover Function**

Function with toggle switch to control the quantity of projected light. Select "NORMAL" or "BRIGHT" to decrease or increase brightness, power consumption and fan noise.

11. **Component Video Input**

Utilizes a component video input signal (Y, P_B, P_R). The video signal is input as separate components to provide superior color and image quality.

12. **Direct Computer Compatibility**

A multi-scan RGB input accepts signals from VGA (640 dots × 480 lines) and Macintosh (from 13" compatible computers) without the need for any additional hardware.

For SHARP Assistance (U.S.A. only)

If you encounter any problems during setup or operation of this projector, first take a look at the section "Troubleshooting" on page 50. If this operation manual does not answer your question, please call toll free 1-877-DTV-SHARP (1-877-388-7427) for further assistance. Or, send us an e-mail at lcdsupport@sharpsec.com. Our World Wide Web address is <http://www.sharp-usa.com/>.



How to Access the PDF Operation Manuals of SharpVision Manager

PDF operation manuals of supplied GAMMA control software “SharpVision Manager” in several languages are included in the CD-ROM. To utilize these manuals, you need to install Adobe Acrobat Reader on your PC (Windows or Macintosh). If you have not installed Acrobat Reader yet, you can download it from the Internet (<http://www.adobe.com>) or install it from the CD-ROM.

To Install Acrobat Reader from the CD-ROM

For Windows:

- ① Insert the CD-ROM in the CD-ROM drive.
- ② Double click on the “My Computer” icon.
- ③ Double click on the “CD-ROM” drive.
- ④ Double click on the “acrobat” folder.
- ⑤ Double click on the “windows” folder.
- ⑥ Double click on the desired installation program and follow the instructions on the screen.

For Macintosh:

- ① Insert the CD-ROM in the CD-ROM drive.
- ② Double click on the “CD-ROM” icon.
- ③ Double click on the “acrobat” folder.
- ④ Double click on the “mac” folder.
- ⑤ Double click on the desired installation program and follow the instructions on the screen.

For other operating systems:

Please download Acrobat Reader from the Internet (<http://www.adobe.com>).

For other languages:

If you prefer using Acrobat Reader for languages other than those included in the CD-ROM, please download the appropriate version from the Internet.

Accessing the PDF Manuals

For Windows:

- ① Insert the CD-ROM in the CD-ROM drive.
- ② Double click on the “My Computer” icon.
- ③ Double click on the “CD-ROM” drive.
- ④ Double click on the “MANUALS” folder.
- ⑤ Double click on the “SVM_U” folder.
- ⑥ Double click on the language (name of the folder) that you want to view.
- ⑦ Double click on the “SVM” pdf file to access the SharpVision Manager manual.

For Macintosh:

- ① Insert the CD-ROM in the CD-ROM drive.
- ② Double click on the “CD-ROM” icon.
- ③ Double click on the “MANUALS” folder.
- ④ Double click on the “SVM_U” folder.
- ⑤ Double click on the language (name of the folder) that you want to view.
- ⑥ Double click on the “SVM” pdf file to access the SharpVision Manager manual.

NOTE

- If the desired PDF file cannot be opened by double clicking the mouse, start Acrobat Reader first, then specify the desired file using the “File”, “Open” menu.
- See the “readme.txt” file on the CD-ROM for important information on the CD-ROM not included in this operation manual.



Contents



Important Information

| | |
|--|-----------|
| IMPORTANT SAFEGUARDS | 3 |
| Outstanding Features | 6 |
| How to Access the PDF Operation | |
| Manuals | 7 |
| Contents | 8 |
| Part Names | 9 |
| Supplied Accessories | 12 |



Setup & Connections

| | |
|---|-----------|
| Connections | 13 |
| Power Supply | 13 |
| Connecting to Video Equipment | 13 |
| Connecting to a DVD Player and DTV | |
| Decoder | 14 |
| Connecting to a Computer | 15 |
| Operating the Remote Control | 16 |
| Using as a Wired Remote Control | 16 |
| Power ON/OFF | 17 |
| Zooming and Focusing | 17 |
| Setting Up the Screen | 18 |
| Using the Adjustment Feet | 18 |
| Using the Lens Shift | 18 |
| Keystone Correction | 19 |
| Adjusting the Projection Distance | 20 |
| Image Projection | 22 |
| Rear Projection | 22 |
| Projection Using a Mirror | 22 |
| Ceiling-mount Projection | 22 |



Operation Buttons

| | |
|--|-----------|
| Using the Operation Buttons | 23 |
| Selecting the Input Signal Source | 23 |
| Adjusting the Picture Aspect Ratio | 23 |
| Gamma Correction Function | 25 |



Basic Operation

| | |
|--------------------------------------|-----------|
| Using the GUI (Graphical User | |
| Interface) Menu Screen | 26 |
| Basic Operations | 26 |

| | |
|--|----|
| Menu Bars | 27 |
| Adjusting the Picture | 29 |
| Adjusting the Computer Images | |
| (RGB menu only) | 32 |
| Reducing Image Noise | |
| (VIDEO menu only) | 36 |
| Turning On/Off the On-screen Display | 37 |
| Setting the Video Signal | |
| (VIDEO menu only) | 37 |
| Theater Mode Functions | 38 |
| Selecting a Background Image | 39 |
| Subtitle Setting | 40 |
| Selecting the Economy Mode | 41 |
| Selecting the Transmission Speed | |
| (RS-232C) | 42 |
| Reversing/Inverting Projected Images | 43 |
| Selecting the On-screen Display | |
| Language | 43 |
| Displaying the Adjustment Settings | 44 |



Maintenance & Troubleshooting

| | |
|---|-----------|
| Lamp/Maintenance Indicators | 45 |
| Lamp Maintenance | 46 |
| Confirming the Lamp Usage Time | 46 |
| Replacing the Lamp | 47 |
| Cleaning the Air Filters | 49 |
| Using the Kensington Lock | 49 |
| Troubleshooting | 50 |
| For SHARP Assistance (U.S.A. only) | 50 |



Appendix

| | |
|---|-----------|
| Connecting Pin Assignments | 51 |
| (RS-232C) Specifications and | |
| Command Settings | 52 |
| Wired Remote Control Terminal | |
| Specifications | 55 |
| Computer Compatibility Chart | 56 |
| Dimensions | 57 |
| Specifications | 58 |
| Glossary | 59 |
| Index | 60 |





Part Names

Numbers next to the part names refer to the main pages in this manual where the topic is explained.

Projector

Front and Top View

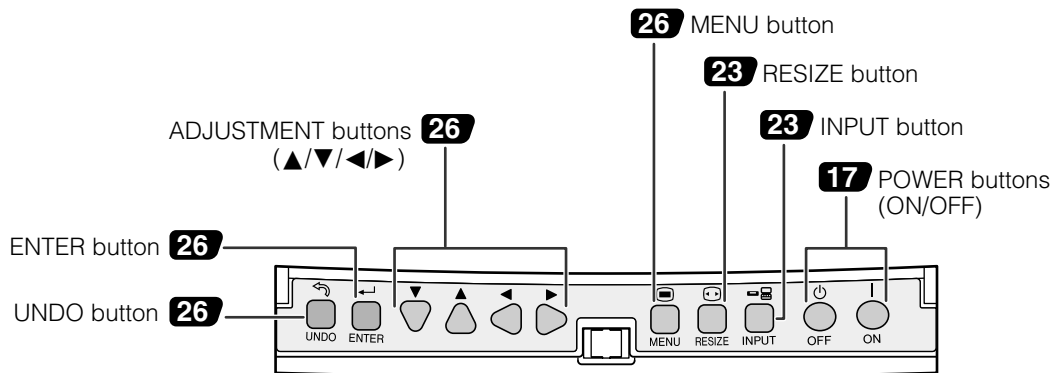
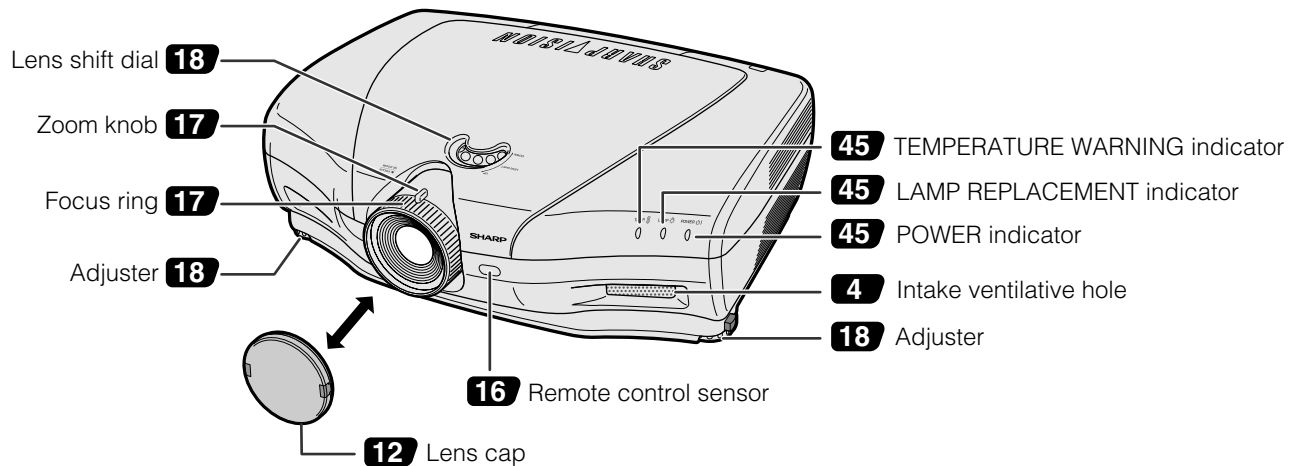

Side and Rear View

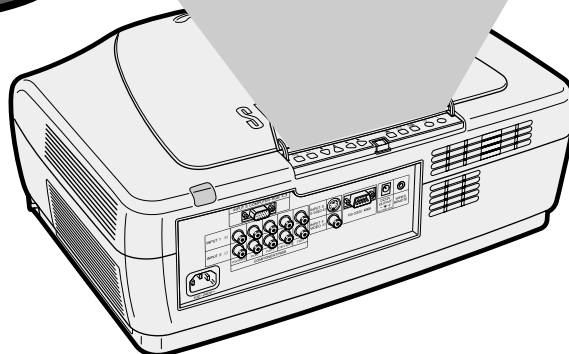



Part Names



Numbers next to the part names refer to the main pages in this manual where the topic is explained.

Projector

Side and Rear View

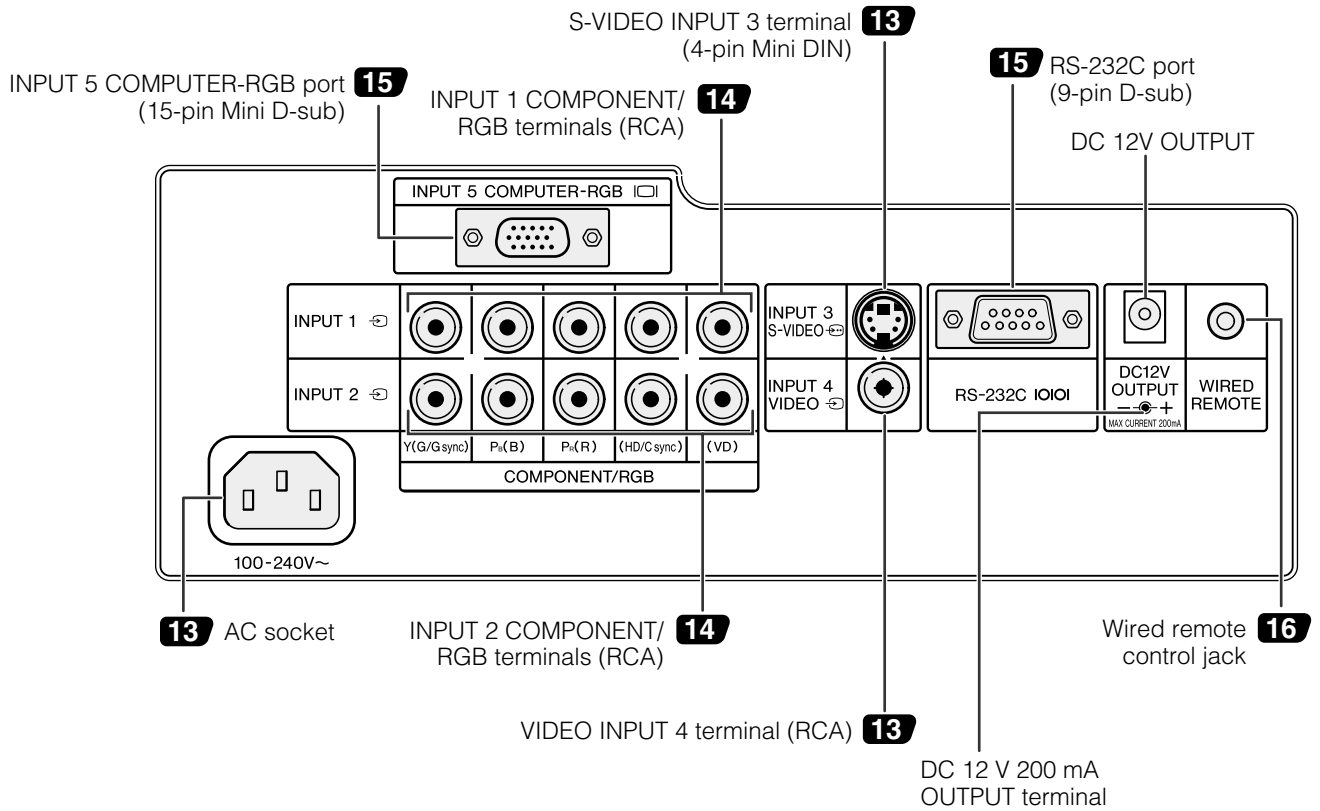
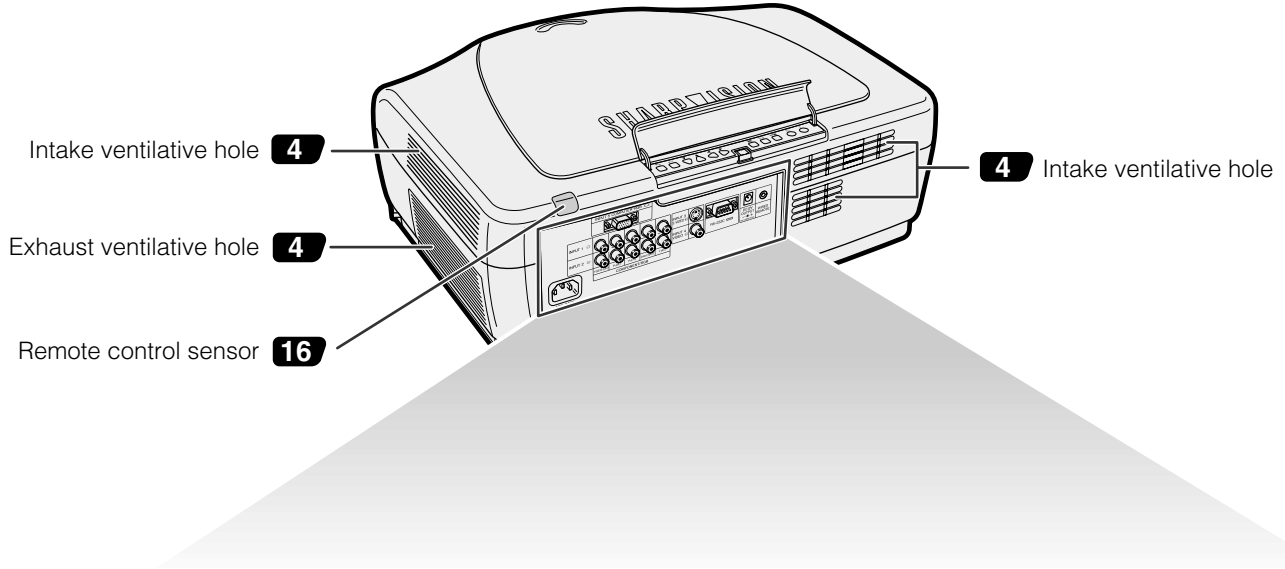



Part Names

Remote Control

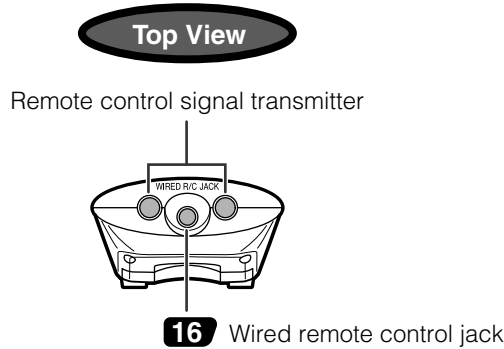
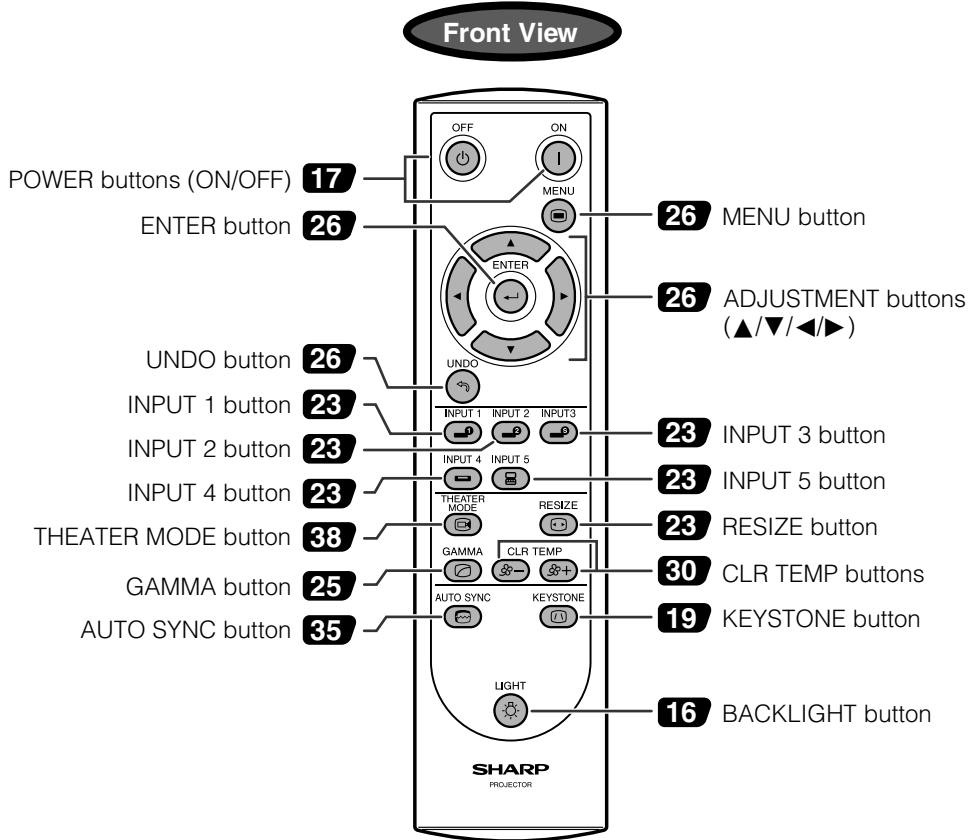

Inserting the batteries

| | | |
|---|--|---|
| <p>1 Pull down the tab on the battery cover and remove the cover towards the direction of the arrow.</p> | <p>2 Insert two AA size batteries, making sure the polarities match the + and - marks inside the battery compartment.</p> | <p>3 Insert the lower tab of the battery cover into the opening, and press the cover until it clicks in place.</p> |
| <p>Battery cover</p> | <p>Battery compartment</p> | <p>Battery cover</p> |



Supplied Accessories

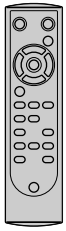

Remote control
RRMCG1657CESA



Two AA size batteries

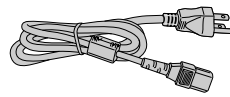

Power cord
CACCU5013DE01

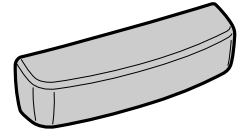

Terminal cover
CCOVA1985CE01

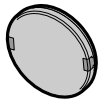

Lens cap
PCAPH1056CESA

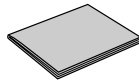

CD-ROM
(SharpVision Manager)
UDSKA0047CEN1

Projector operation manual
TINS-7416CEZZ

SharpVision Manager operation manual
TINS-7418CEZZ

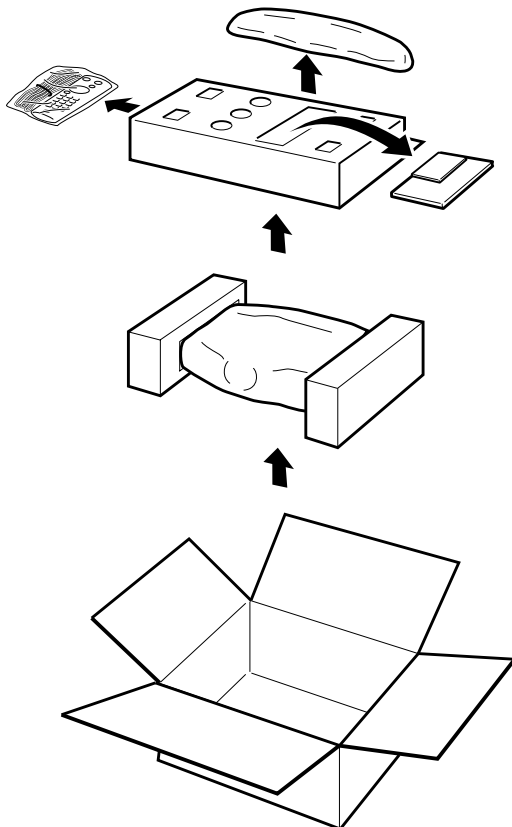



Connections



Power Supply

Connecting the Power Cord

Plug the supplied power cord into the AC socket on the back of the projector.

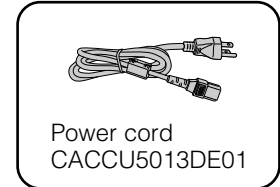
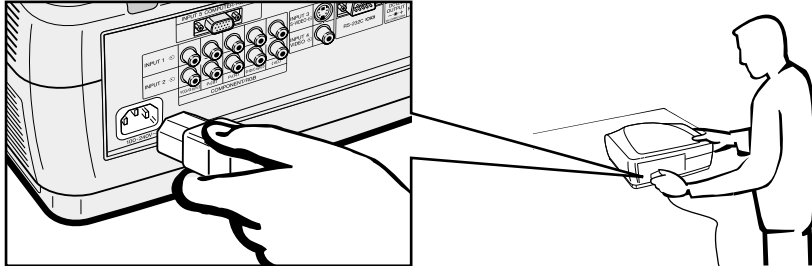

Power cord
CACCU5013DE01

CAUTION

- Make sure the power cord is firmly connected into the AC socket.

NOTE

- The projector will enter the stand-by mode after turning the power off and then re-plugging the power cord into the AC socket. However, if you turned off the power by disconnecting the power cord or because of a power failure, the projector will automatically turn on without pressing the **POWER ON** button.



Connecting to Video Equipment

You can connect your projector to a VCR, laser disc player, DVD player, DTV* decoder and other video equipment.

* DTV is the umbrella term used to describe the new digital television system in the United States.

CAUTION

- Make sure to turn both the projector and the video equipment off, before connecting.

NOTE

- As this projector is not equipped with audio input terminals, commercially available audio equipment or your own equipment (such as speakers or amplifiers) should be used.

Connecting a video source (VCR, laser disc player, DVD player or DTV decoder) using the INPUT 3 S-VIDEO and INPUT 4 VIDEO terminals

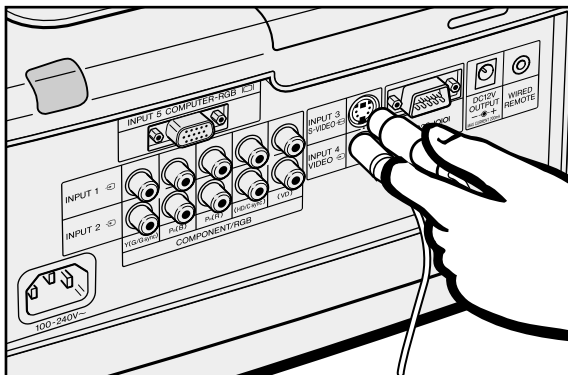

- ① Connect one end of the S-video cable (commercially available) to the **INPUT 3 S-VIDEO** terminal, or one end of the video cable (commercially available) to the **INPUT 4 VIDEO** terminal on the projector.
- ② Connect the other end of the S-video cable or the video cable to the S-video output or Video output terminal of the video source.

The S-video input terminal uses a video signal system where the picture is separated into a color and luminance signal to realize a higher-quality image.

NOTE

- For higher quality video, you may use the S-video input terminal on the projector. S-video cable is commercially available.
- If your video equipment does not have an S-video output terminal, use the composite video output terminal.



Connecting to Video Equipment

Projector

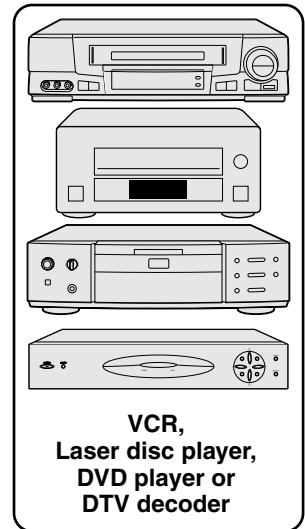
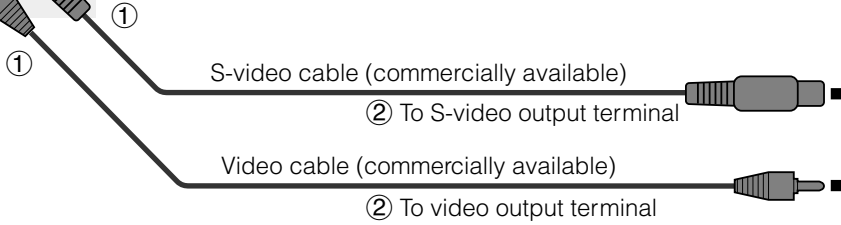
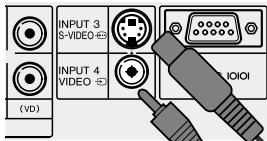

Connecting to a DVD Player and DTV Decoder

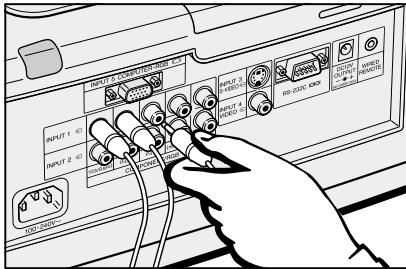

- ① Connect each RCA connector of a component cable to the corresponding RCA INPUT 1 or 2 terminals on the projector.
- ② Connect the other end of the cable to the corresponding terminals on a DVD player or DTV decoder.

When connecting this projector to a DVD player or DTV decoder, select "Component" for "Signal Type" on the GUI menu. (See page 31.)

CAUTION

- Make sure to turn both the projector and the video equipment off, before connecting.

Projector

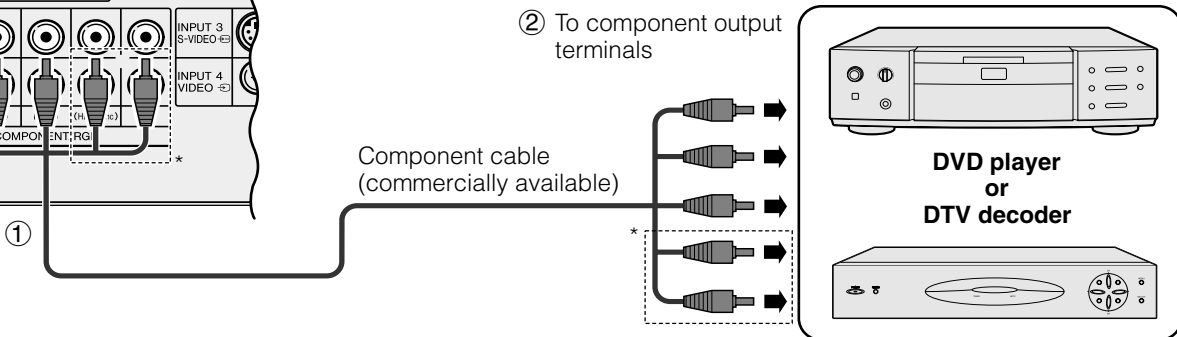
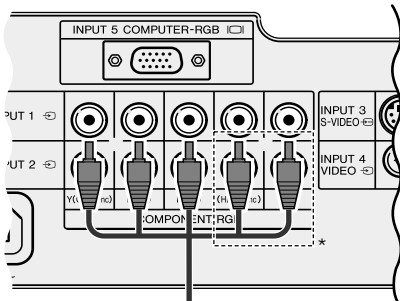

* The (HD/C sync) and (VD) terminals may be used depending on the specifications of the DTV decoder connected to this projector. Please refer to the operation manual of the DTV decoder for details.



Connecting to a Computer

When the RS-232C port on the projector is connected to a computer with an RS-232C cable (null modem, cross type, commercially available), the computer can be used to control the projector and check the status of the projector. See pages 52, 53 and 54 for details.

Connecting to a computer using the INPUT 5 COMPUTER-RGB port

- ① Connect one end of the RGB cable (commercially available) to the INPUT 5 COMPUTER-RGB port on the projector.
- ② Connect the other end of the corresponding port on a computer.

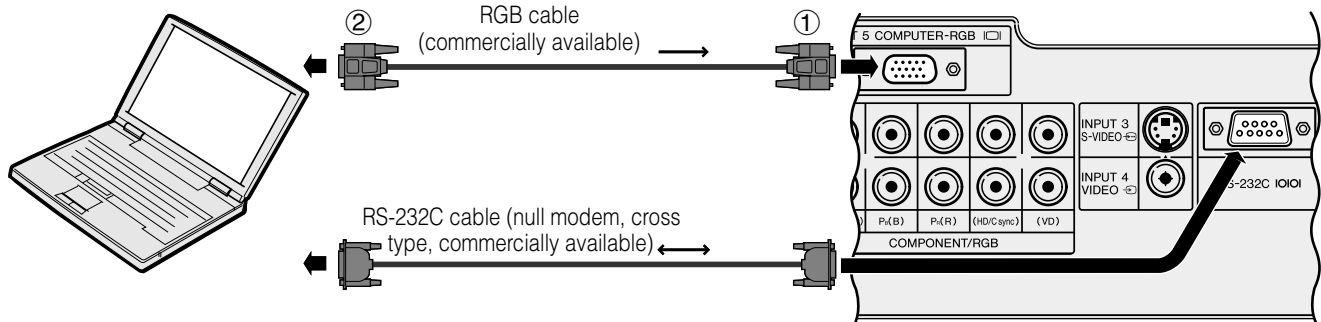

Connect an RS-232C cable (null modem, cross type, commercially available) to the serial port on the computer.

CAUTION

- Do not connect or disconnect an RS-232C cable to or from the computer while it is on. This may damage your computer.

NOTE

- Refer to "Computer Compatibility Chart" on page 56 for a list of computer signals compatible with the projector. Use with computer signals other than those listed may cause some of the functions not to work.
- The RS-232C function may not operate if your computer port is not correctly set up. Please refer to the operation manual of the computer for details.
- The arrows (→, ↔) in the configuration above indicate the direction of the signals.
- A Macintosh adaptor may be required for use with some Macintosh computers. Contact your nearest Authorized SharpVision Service Center or Dealer.



Operating the Remote Control

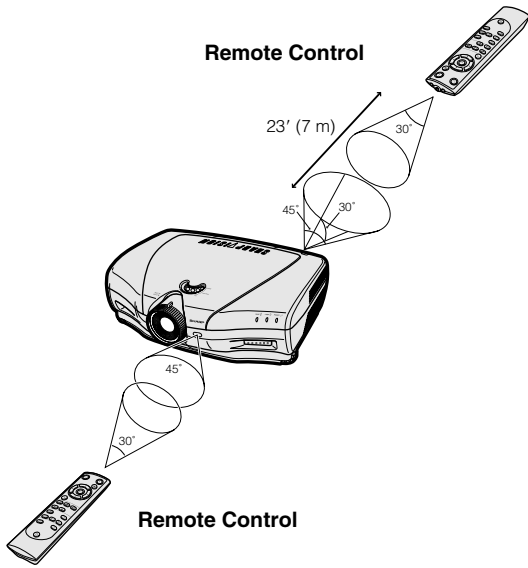

The remote control can be used to control the projector within the range shown on the left.

NOTE

- The signal from the remote control can be reflected off a screen for easy operation. However, the effective distance of the signal may differ due to the screen material.



Using the remote control in a dark room

The backlights of the operation buttons can be turned on for five seconds and off by pressing **BACKLIGHT**. If you want to turn off the backlights while they are on, press **BACKLIGHT** again.

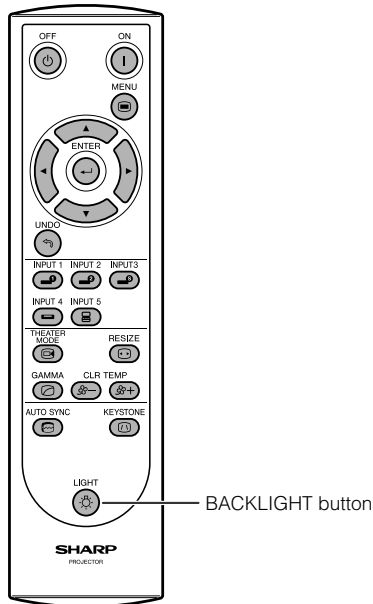

Using as a Wired Remote Control

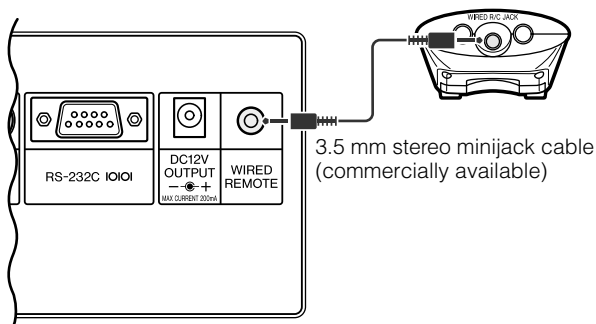

When the remote control cannot be used due to the range or positioning of the projector (rear projection, etc.), connect a 3.5 mm stereo minijack cable (commercially available) from the wired remote control jack on the top of the remote control to the Wired remote control jack on the back of the projector.



Power ON/OFF

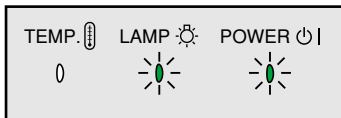
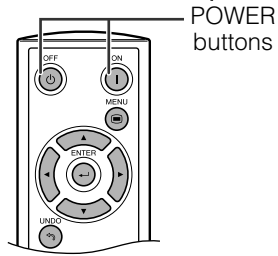
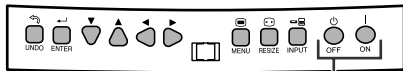

Press **POWER ON**.

- The flashing blue LAMP REPLACEMENT indicator shows that the lamp is warming up. Wait until the indicator stops flashing before operating the projector.
- If the power is turned off and then immediately turned on again, it may take a short while before the lamp turns on.

NOTE

- After the projector is unpacked and turned on for the first time, a slight odor may be emitted from the exhaust ventilative hole. This odor will soon disappear with use.

When the power is on, the LAMP REPLACEMENT indicator lights, indicating the status of the lamp.

Blue: Lamp is ready.

Flashing blue: Warming up.

Red: Change the lamp.

Press **POWER OFF**.

Press **POWER OFF** again while the message is displayed.

NOTE

- If you accidentally pressed **POWER OFF** and do not want to turn off the power, wait until the message disappears.
- When **POWER OFF** is pressed twice, the POWER indicator will light up red and the cooling fan will run for about 90 seconds. The projector will then enter standby mode.
- Wait until the cooling fan stops running before disconnecting the power cord.
- The power can be turned on again by pressing **POWER ON**. When the power is turned on, the POWER indicator and the LAMP REPLACEMENT indicators light blue.



Zooming and Focusing

The picture can be zoomed in or out, and focused by the Zoom knob and the Focus ring.

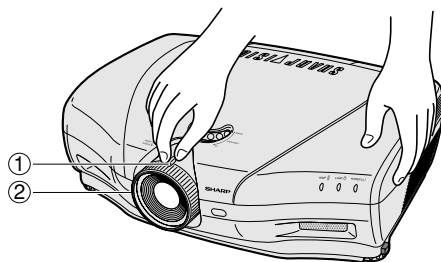

- ① Slide the Zoom knob. The image can be adjusted to the desired size within the zoom range.
- ② Rotate the Focus ring until the image on the screen becomes clear.



Setting Up the Screen



Using the Adjustment Feet

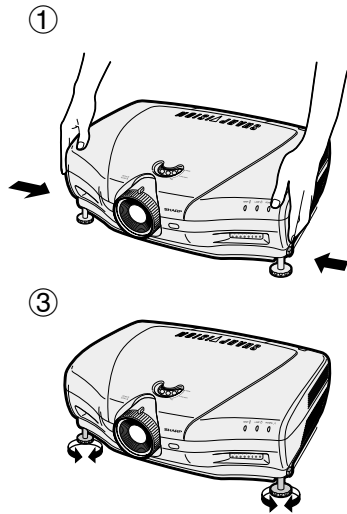

You can adjust the height of the image by raising the projector with the foot releases.

- ① Press the foot releases and lift the projector to the desired angle.
- ② Remove your hands from the foot releases. Once the adjustment feet have locked in position, release the projector.
- ③ If the screen is at an angle, the adjusters can be used to adjust the angle of the image.

Returning the projector to its original position

While holding the projector, press the foot releases and slowly lower the projector to its original position.

CAUTION

- Do not hold the lens when lifting or lowering the projector.
- When lowering the projector, be careful not to get your fingers caught in the area between the adjustment feet and the projector.

NOTE

- The projector is adjustable up to approximately 5° from the standard position.
- When the height of the projector is adjusted, the image may become distorted (keystoned), depending on the relative positions of the projector and the screen. See page 19 for details on the keystone correction.



Using the Lens Shift

The picture can be adjusted within the shift range of the lens by rotating the lens shift dial on the top of the projector using your finger.

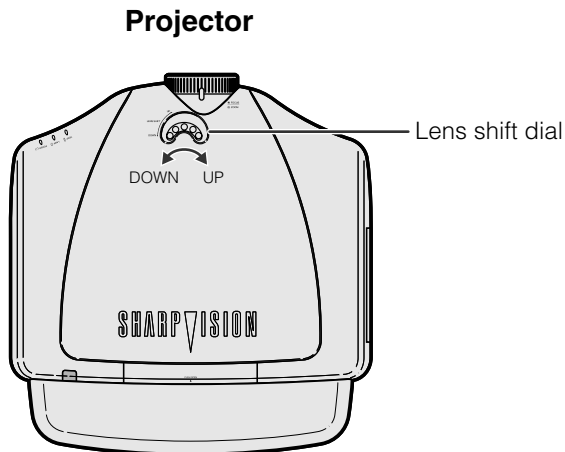

Projected Image

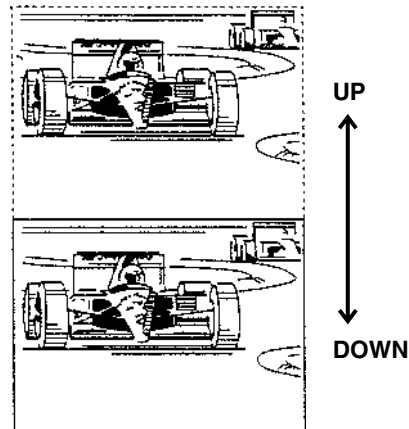



Keystone Correction

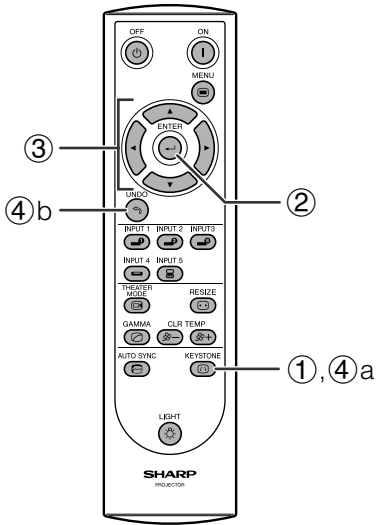

This function can be used to adjust the Keystone settings.

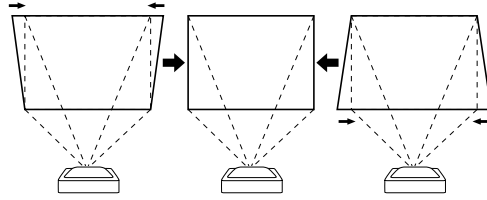

- ① Press **KEYSTONE** on the remote control.
- ② Press **ENTER** to display the test pattern.
- ③ Press **▲/▼/◀/▶** to make adjustments.
- ④ a. Press **KEYSTONE** to return to the normal screen.
b. To reset the Keystone setting, press **UNDO**.

NOTE

- Straight lines and the edges of the displayed image may appear jagged, when adjusting the Keystone setting.

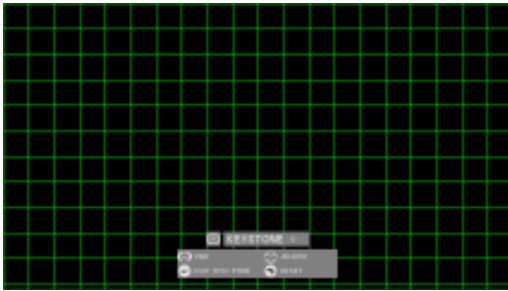



Adjusting the Projection Distance

Position the projector perpendicular to the screen with all feet flat and leveled to achieve an optimal image. Move the projector forward or backward if the edges of the image are distorted.

NOTE

- The projector lens should be centered in the middle of the screen. If the lens center is not perpendicular to the screen, the image will be distorted, making viewing difficult.
- Position the screen so that it is not in direct sunlight or room light. Light falling directly onto the screen washes out colors, making viewing difficult. Close the curtains and dim the lights when setting up the screen in a sunny or bright room.
- A polarizing screen cannot be used with this projector.

Standard Setup (Front Projection)

Place the projector at the required distance from the screen according to the desired screen size. (See the tables below.) The figures in the tables are based upon projecting an image so that it occupies the entire screen.

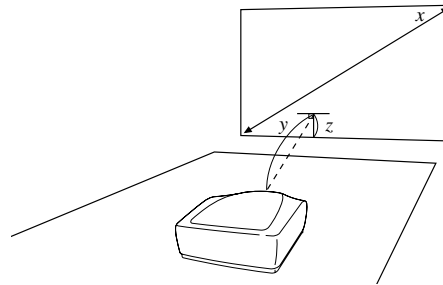

When using a normal screen (4:3)

In case of setting the 16:9 picture to the full horizontal width of the 4:3 screen.

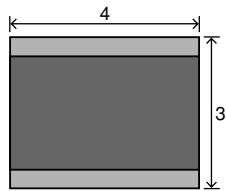

□ : Screen area
■ : Picture area

| Screen size (4:3) | | | Projection Distance (y) | | Distance from the lens center to the lower edge of the image (z) | |
|-------------------|-------|--------|---------------------------|---------------------------|--|-------------------------|
| Diag. (x) | Width | Height | Maximum (y ₁) | Minimum (y ₂) | Upper (z ₁) | Lower (z ₂) |
| 250" | 200" | 150" | 41'4" (12.6 m) | 30'6" (9.3 m) | 0" (0 cm) | -12'6" (-286 cm) |
| 200" | 160" | 120" | 33' (10.1 m) | 24'4" (7.4 m) | 0" (0 cm) | -10' (-229 cm) |
| 150" | 120" | 90" | 24'9" (7.5 m) | 18'3" (5.6 m) | 0" (0 cm) | -7'6" (-171 cm) |
| 100" | 80" | 60" | 16'5" (5.0 m) | 12'1" (3.7 m) | 0" (0 cm) | -5' (-114 cm) |
| 84" | 67" | 50" | 13'9" (4.2 m) | 10'2" (3.1 m) | 0" (0 cm) | -4'2" (-96 cm) |
| 72" | 58" | 43" | 11'10" (3.6 m) | 8'8" (2.6 m) | 0" (0 cm) | -3'7" (-82 cm) |
| 60" | 48" | 36" | 9'10" (3.0 m) | 7'2" (2.2 m) | 0" (0 cm) | -3' (-69 cm) |

The formula for screen size and projection distance

$$y_1 (\text{Max.}) = (0.05058x - 0.0447) \times 3.28$$

$$y_2 (\text{Min.}) = (0.03734x - 0.0447) \times 3.28$$

$$z_1 (\text{Upper}) = 0$$

$$z_2 (\text{Lower}) = -0.45x$$

x : Screen size (diag.) (inches)

y : Projection distance (feet)

z : Distance from the lens center to the lower edge of the screen (feet)

NOTE

- There is an error of $\pm 3\%$ in the formula above.
- Values with a minus (-) sign indicate the distance of the lens center below the bottom of the screen.

When using a wide screen (16:9)

In case of displaying the 16:9 picture on the whole of the 16:9 screen.

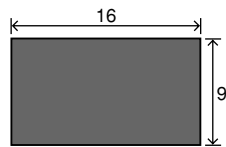

■ : Picture area

| Screen size (16:9) | | | Projection Distance (y) | | Distance from the lens center to the lower edge of the image (z) | |
|--------------------|-------|--------|---------------------------|---------------------------|--|-------------------------|
| Diag. (x) | Width | Height | Maximum (y ₁) | Minimum (y ₂) | Upper (z ₁) | Lower (z ₂) |
| 300" | 261" | 147" | 54'1" (16.5 m) | 39'11" (12.2 m) | 0" (0 cm) | -12'3" (-374 cm) |
| 250" | 218" | 123" | 45'1" (13.7 m) | 33'3" (10.1 m) | 0" (0 cm) | -10'3" (-311 cm) |
| 200" | 174" | 98" | 36' (11.0 m) | 26'7" (8.1 m) | 0" (0 cm) | -8'2" (-249 cm) |
| 150" | 131" | 74" | 26'12" (8.2 m) | 19'11" (6.1 m) | 0" (0 cm) | -6'2" (-187 cm) |
| 133" | 116" | 65" | 23'11" (7.3 m) | 17'7" (5.4 m) | 0" (0 cm) | -5'5" (-166 cm) |
| 106" | 92" | 52" | 18'11" (5.8 m) | 13'11" (4.3 m) | 0" (0 cm) | -4'4" (-131 cm) |
| 100" | 87" | 49" | 17'11" (5.5 m) | 13'2" (4.0 m) | 0" (0 cm) | -4'1" (-125 cm) |
| 92" | 80" | 45" | 16'5" (5.0 m) | 12'1" (3.7 m) | 0" (0 cm) | -3'9" (-114 cm) |
| 84" | 73" | 41" | 15' (4.6 m) | 11'1" (3.4 m) | 0" (0 cm) | -3'5" (-105 cm) |
| 72" | 63" | 35" | 12'10" (3.9 m) | 9'6" (2.9 m) | 0" (0 cm) | -2'11" (-90 cm) |
| 60" | 52" | 29" | 10'8" (3.3 m) | 7'10" (2.4 m) | 0" (0 cm) | -2'5" (-75 cm) |
| 40" | 35" | 20" | 7'1" (2.2 m) | 5'2" (1.6 m) | 0" (0 cm) | -1'8" (-50 cm) |

The formula for screen size and projection distance

$$y_1 (\text{Max.}) = (0.05510x - 0.04593) \times 3.28$$

$$y_2 (\text{Min.}) = (0.04068x - 0.04369) \times 3.28$$

$$z_1 (\text{Upper}) = 0$$

$$z_2 (\text{Lower}) = -0.4904x$$

x : Screen size (diag.) (inches)

y : Projection distance (feet)

z : Distance from the lens center to the lower edge of the screen (feet)

NOTE

- There is an error of $\pm 3\%$ in the formula above.
- Values with a minus (-) sign indicate the distance of the lens center below the bottom of the screen.





Adjusting the Projection Distance

Upper and Lower Lens Shift Position

- This projector is equipped with a lens shift function that lets you adjust the projection height.
- Adjust it to match the setup configuration.
- The screen can be moved maximum the length of one screen vertically using the lens shift.

NOTE

- Optimal image quality is produced with the projector positioned perpendicular to the screen with all feet flat and level. Tilting or angling the projector will reduce the effectiveness of the lens shift function.

Screen size: 100 inches (254 cm)

Aspect ratio: 16:9

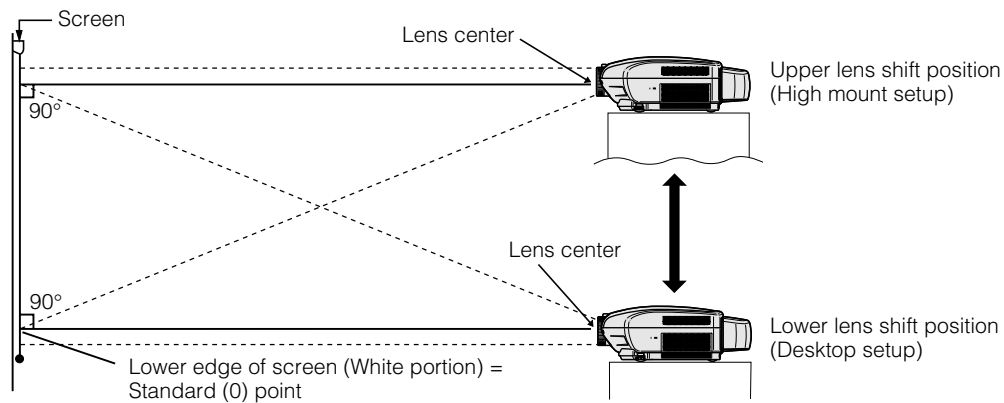

Upper and Lower Lens Shift Position (Ceiling Mount)

When the projector is in the inverted position, use the upper edge of the screen as the base line, and exchange the lower and upper lens shift values.

Screen size: 100 inches (254 cm)

Aspect ratio: 16:9

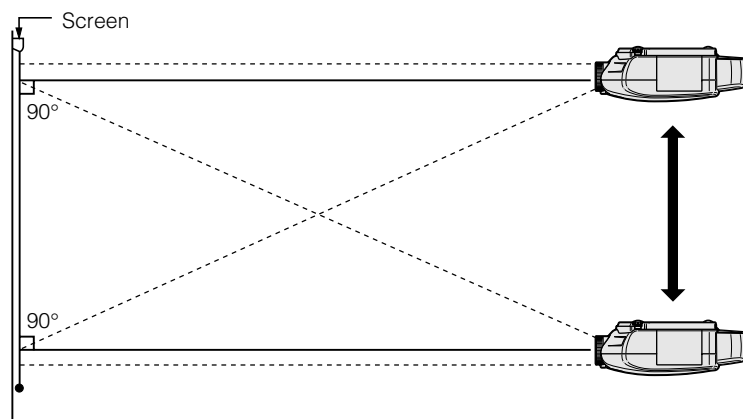
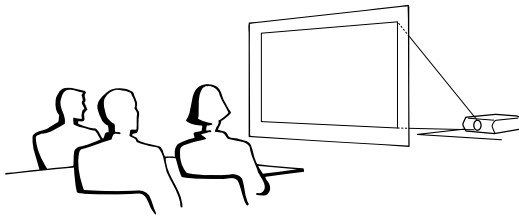



Image Projection



Rear Projection



- Place a translucent screen between the projector and the audience.
- Use the projector's menu system to reverse the projected image. (See page 43 for use of this function.)

NOTE

- Optimal image quality can be achieved when the projector is positioned perpendicular to the screen with all feet flat and leveled.



Projection Using a Mirror

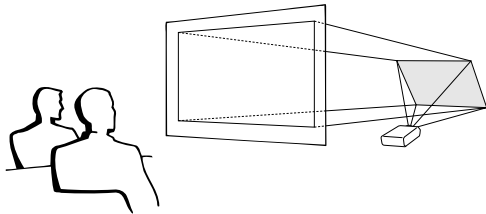

- When the distance between the projector and screen is not sufficient for normal rear projection, you can use a mirror to reflect the image onto the screen.
- Place a mirror (normal flat type) in front of the lens.
- Project the normal image onto the mirror.
- The image reflected from the mirror is projected onto the translucent screen.

CAUTION

- When using a mirror, be sure to carefully position both the projector and the mirror so the light does not shine into the eyes of the audience.



Ceiling-mount Projection

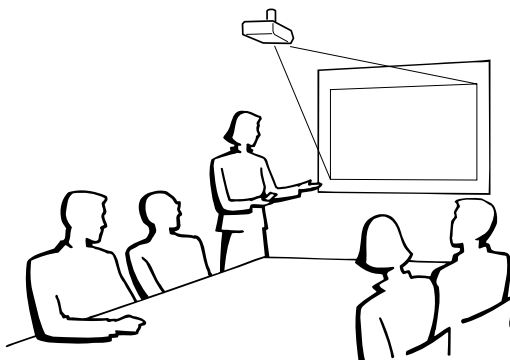

- It is recommended that you use the optional Sharp ceiling-mount bracket for this installation.
- Before mounting the projector, contact your nearest Authorized SharpVision Service Center or Dealer to obtain the recommended ceiling-mount bracket (commercially available). (AN-CM230 ceiling-mount bracket, AN-EP101A extension tube for AN-CM230.)
- When the projector is in the inverted position, use the upper edge of the screen as the base line.
- Use the projector's menu system to select the appropriate projection mode. (See page 43 for use of this function.)





Using the Operation Buttons



Selecting the Input Signal Source

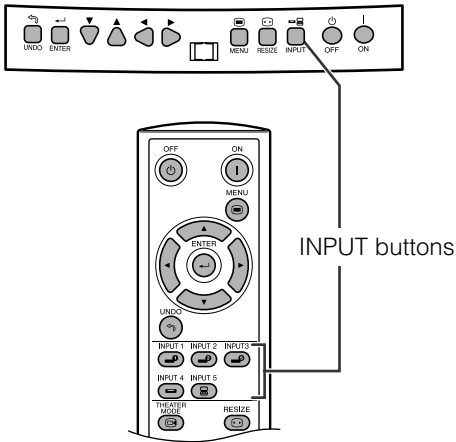

Press **INPUT** on the projector, **INPUT 1**, **INPUT 2**, **INPUT 3**, **INPUT 4** or **INPUT 5** on the remote control to select the desired input mode.

NOTE

- When no signal is received, "NO SIGNAL" will be displayed.
- When a signal that the projector is not preset to receive is received, "NOT REG." will be displayed.

On-screen Display

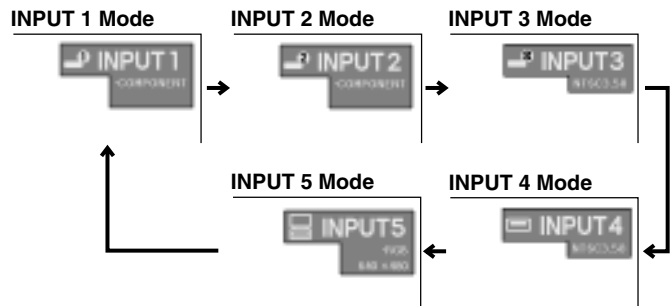

Adjusting the Picture Aspect Ratio

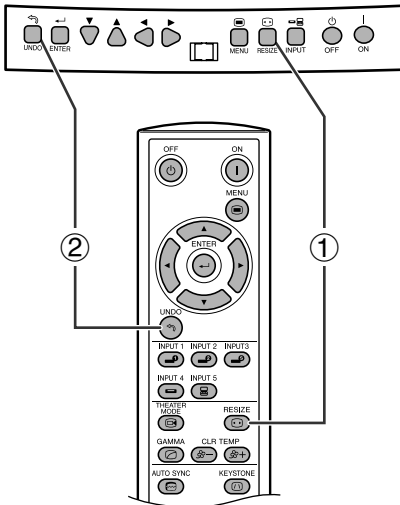

This function allows you to modify or customize the picture display mode to enhance the input image. Depending on the input signal, you can choose SIDE BAR, SMART STRETCH, CINEMA ZOOM, STRETCH, NORMAL, or DOT BY DOT image.

- Press **RESIZE**. Each time **RESIZE** is pressed, the picture mode changes as shown on the next page.
- To return to the standard image, press **UNDO** while "RESIZE" is displayed on the screen.



Adjusting the Picture Aspect Ratio

VIDEO/DVD/DTV

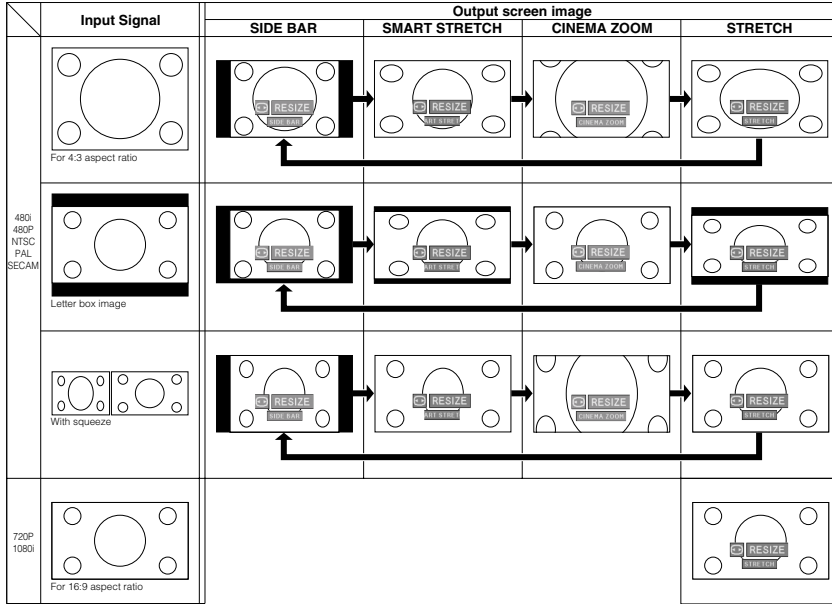

EXAMPLE

| | | SIDE BAR | SMART STRETCH | CINEMA ZOOM | STRETCH |
|-----------------------|--------------------------------------|------------|---------------|-------------|------------|
| For 4:3 aspect ratio | 480i 480P NTSC PAL SECAM | 960 × 720 | 1280 × 720 | 1280 × 720 | 1280 × 720 |
| For 16:9 aspect ratio | 480P | 960 × 720 | 1280 × 720 | 1280 × 720 | 1280 × 720 |
| | 720P | 1280 × 720 | - | - | - |
| | 1080i | 1280 × 720 | - | - | - |

COMPUTER

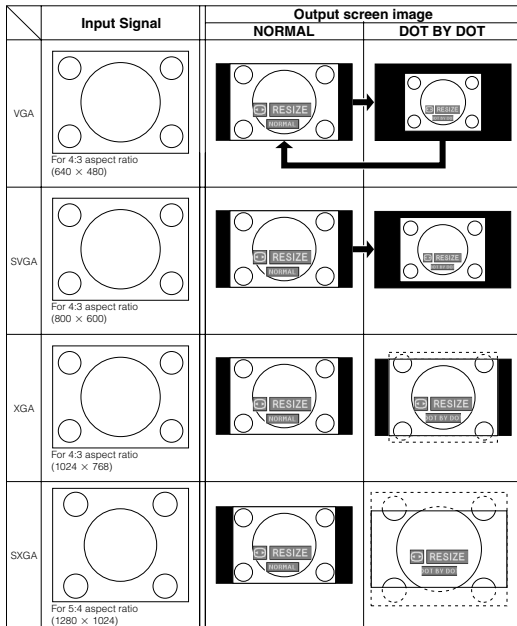

EXAMPLE

| | | NORMAL | DOT BY DOT |
|------------------------------|--------------------|-----------|------------|
| For 4:3 aspect ratio | SVGA (800 × 600) | 960 × 720 | 800 × 600 |
| | XGA (1024 × 768) | 960 × 720 | 1024 × 720 |
| | SXGA (1280 × 960) | 960 × 720 | 1280 × 720 |
| For without 4:3 aspect ratio | SXGA (1280 × 1024) | 900 × 720 | 1280 × 720 |





Gamma Correction Function

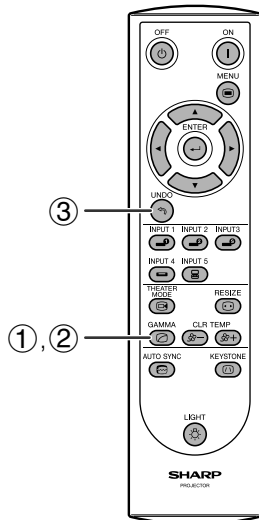

On-screen Display

STANDARD

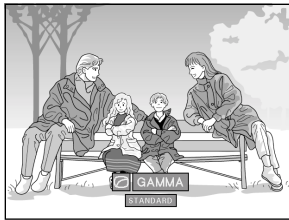

GAMMA 1

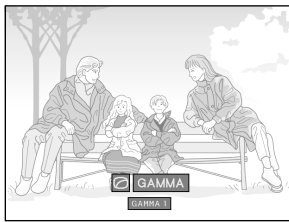

GAMMA 2

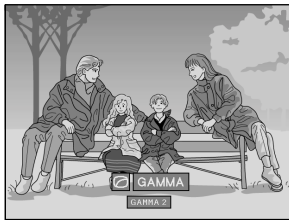

CUSTOM

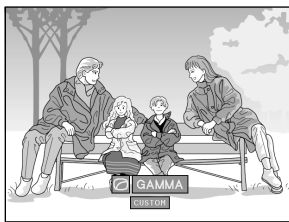

- Gamma is an image quality enhancement function that offers a richer image by brightening the darker portions of the image without altering the brightness of the brighter portions.
- Four gamma settings are available to allow for differences in the images displayed and in the brightness of the room.
- When you are displaying images with frequent, dark scenes, such as a film or concert, or when you are displaying images in a bright room, this feature makes the dark scenes easier to see and gives the impression of greater depth in the image.

Gamma Modes

| Selected Mode | Gamma mode |
|-----------------|--|
| STANDARD | Standard picture without gamma correction. |
| GAMMA 1 | Brightens darker portions of images for more enhanced presentations. |
| GAMMA 2 | Gives greater depth to darker portions of images for a more exciting theater experience. |
| CUSTOM | Allows you to adjust gamma value using SharpVision Manager (supplied). |

- ① Press **GAMMA** to display "GAMMA". Then, the present Gamma mode is displayed.
- ② Each time **GAMMA** is pressed, the gamma level toggles as shown on the left.
- ③ To return to the standard image, press **UNDO** while "GAMMA" is displayed on the screen.

NOTE

- The CUSTOM setting of VIDEO mode optimizes the video source to reproduce the image more beautifully. It darkens bright portions of the image and gives greater depth to darker portions of the image. Select CUSTOM as your default setting if you prefer a smooth textured image to a sharply contrasted one.
- STANDARD and GAMMA 2 settings of VIDEO mode (except COMPONENT 480P/720P/1080i) incorporate a DYNAMIC GAMMA function for optimizing GAMMA correction frame by frame in real time, thus providing a more beautiful image.
- GAMMA 1 settings are the same for both RGB and VIDEO modes.





Using the GUI (Graphical User Interface) Menu Screen



Basic Operations

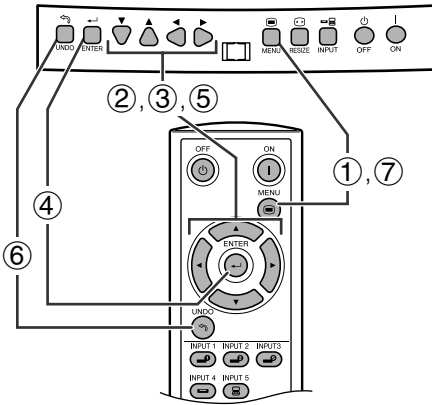

This projector has two sets of menu screens that allow you to adjust the image and various projector settings. These menu screens can be operated from the projector or the remote control with the following procedure.

(GUI) On-screen Display

INPUT 3, 4 (VIDEO) mode

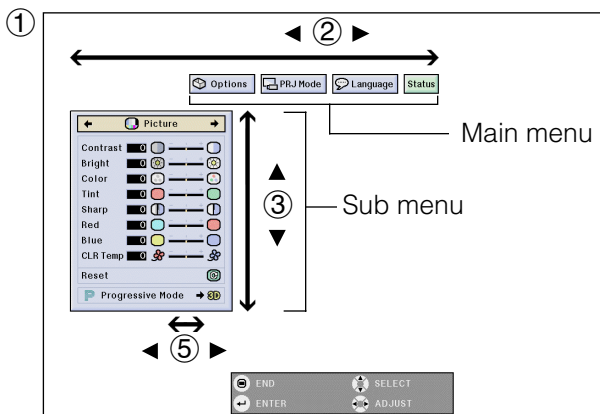

INPUT 1, 2 (COMPONENT) or 5 (RGB) mode

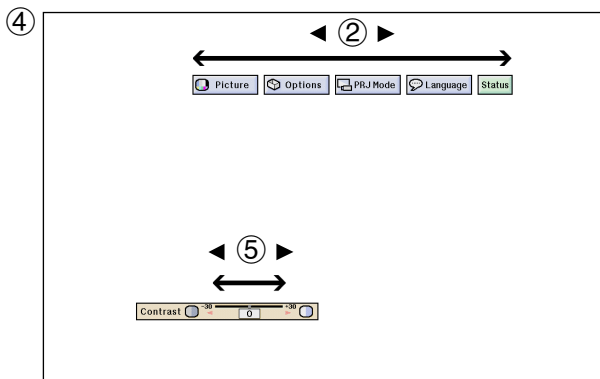
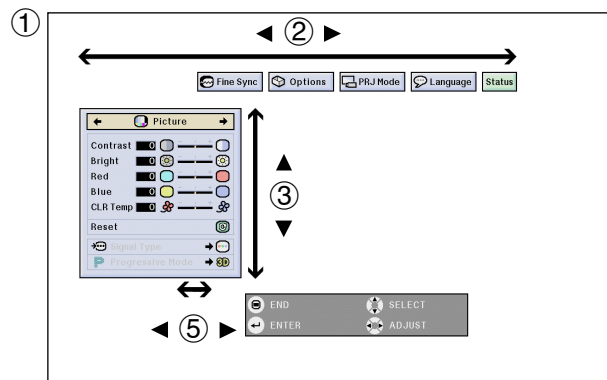

- ① Press **MENU** to display the INPUT 1, 2, 3, 4 or 5 mode menu bar.
- ② Press **◀/▶** to select an adjustment main menu on the menu bar.
- ③ Press **▲/▼** to select a specific adjustment item.
- ④ To display a single adjustment item, press **ENTER** after selecting the item. Only the menu bar and the selected adjustment item will appear.
- ⑤ Press **◀/▶** to adjust the item.
- ⑥ Press **UNDO** to return to the previous screen.
- ⑦ To exit the GUI, press **MENU**.

NOTE

- For details on items on the menu screen, see the tree charts on pages 27 and 28.





Menu Bars

Items on the INPUT 3 or 4 Mode Menu Bar

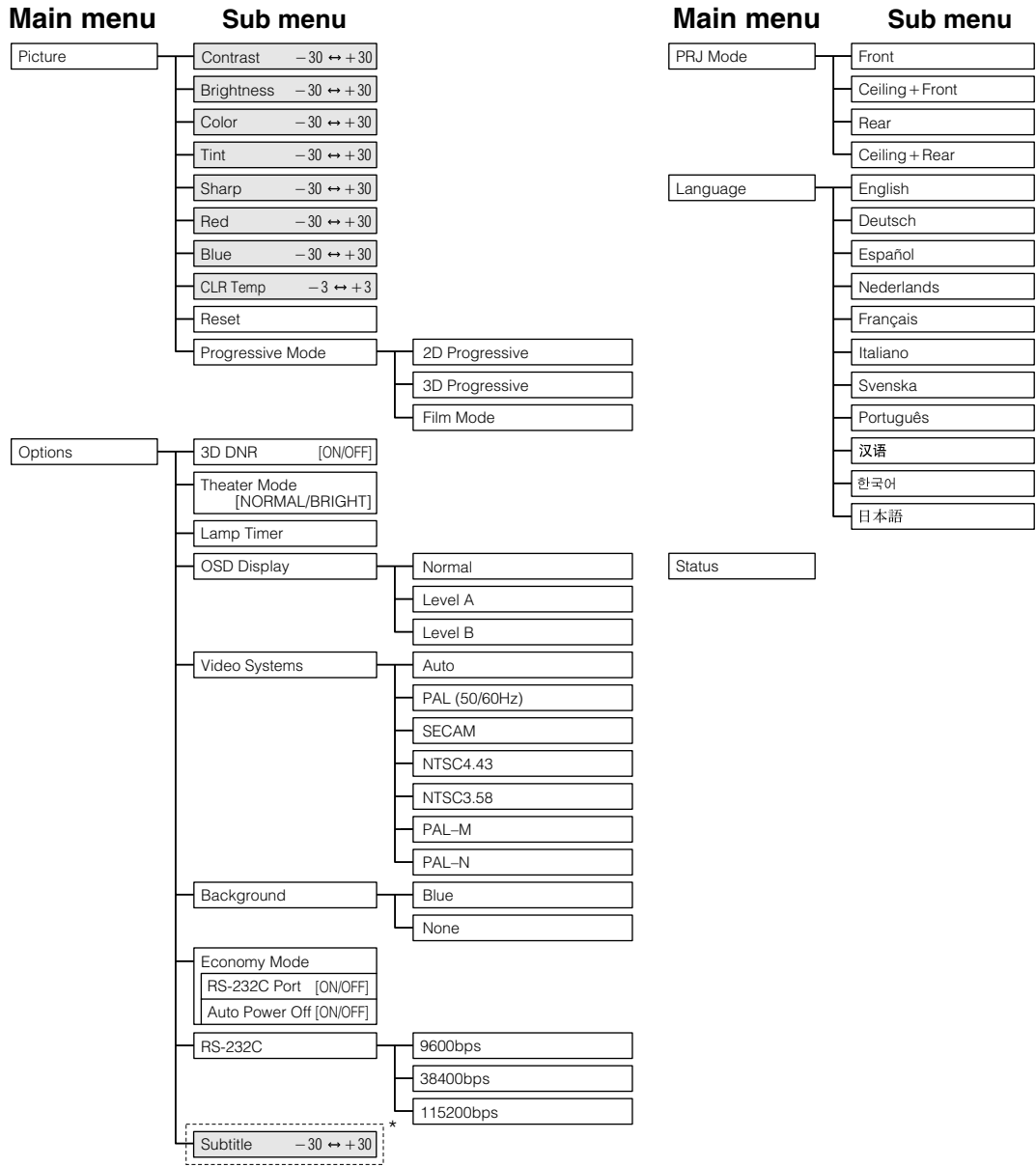

* These values may be changed using the RESIZE mode.

NOTE

- Only the items highlighted in the tree charts above can be adjusted.
- To adjust the items under the sub menu, press ► after selecting the sub menu.





Items on the INPUT 1, 2 or 5 Mode Menu Bar

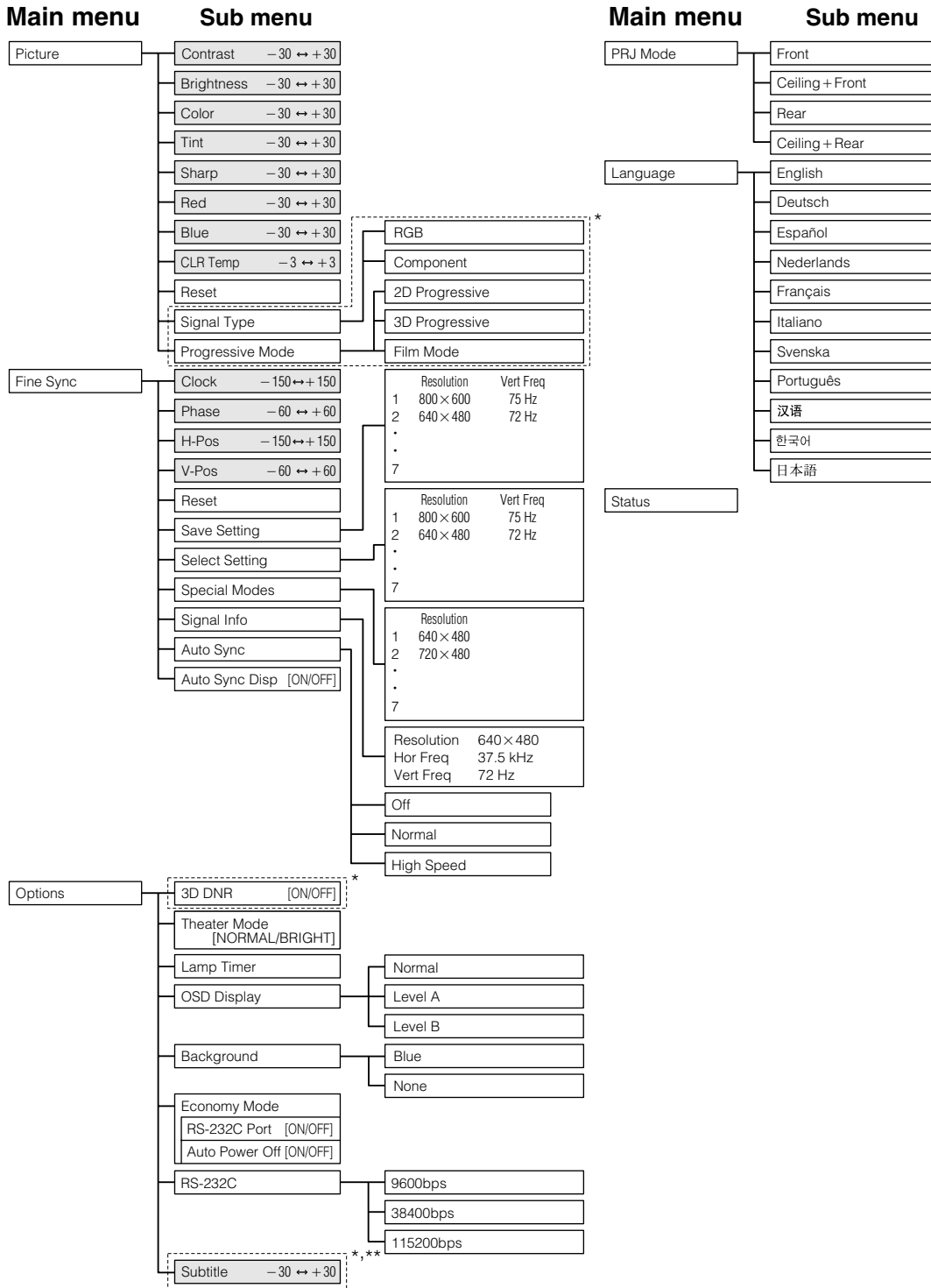

* Not displayed in the INPUT 5 mode.
 ** These values may be changed using the RESIZE mode.

NOTE

- The resolution, vertical frequency and horizontal frequency figures displayed above are for example purposes only.
- "Color", "Tint", and "Sharp" appear only when Component is selected in INPUT 1 or 2 mode.
- Only the items highlighted in the tree charts above can be adjusted.
- To adjust the items under the sub menu, press ► after selecting the sub menu.





Adjusting the Picture

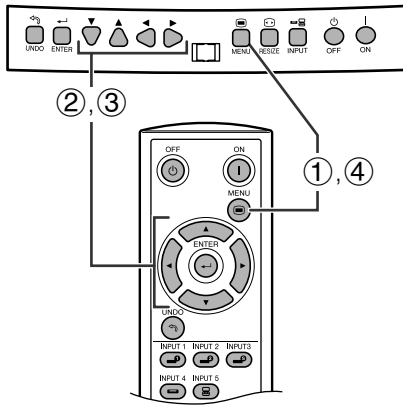

(GUI) On-screen Display
e. g. (VIDEO input in INPUT 3 or 4 mode)

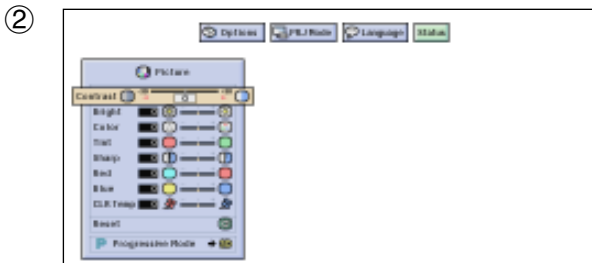
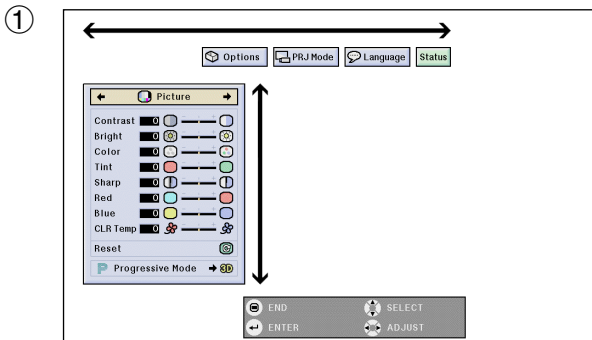

You can adjust the projector's picture to your preferences with the following picture settings.

Description of Adjustment Items

| Selected item | ◀ button | ▶ button |
|-------------------|---|----------------------------|
| Contrast | For less contrast | For more contrast |
| Brightness | For less brightness | For more brightness |
| Color | For less color intensity | For more color intensity |
| Tint | Skin tones become purplish | Skin tones become greenish |
| Sharp | For less sharpness | For more sharpness |
| Red | For weaker red | For stronger red |
| Blue | For weaker blue | For stronger blue |
| Reset | All image adjustment items are returned to the factory preset settings. | |

NOTE

- “Color”, “Tint” and “Sharp” do not appear for RGB input in INPUT 5 mode.

- 1 Press **MENU**. Menu bar and “Picture” menu screen appear. GUI operation guide is also displayed.
- 2 Press ▲/▼ to select a specific adjustment item.
- 3 Press ◀/▶ to move the ■ mark of the selected adjustment item to the desired setting.
- 4 To exit the GUI, press **MENU**.

NOTE

- To reset all adjustment items, select “Reset” on the “Picture” menu screen and press **ENTER**.
- The adjustments can be stored separately in the INPUT 1 to 5 modes.



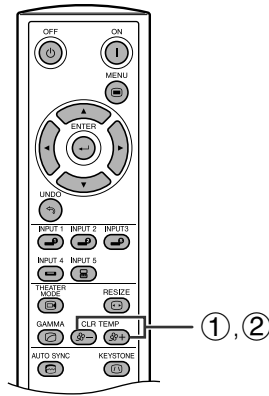

On-screen Display

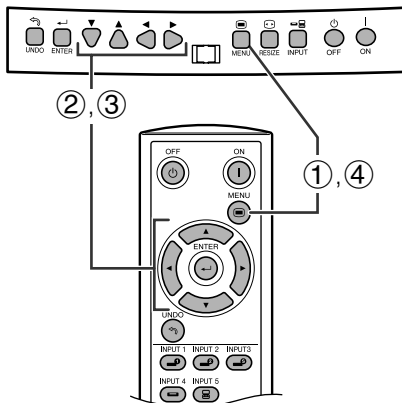

(GUI) On-screen Display

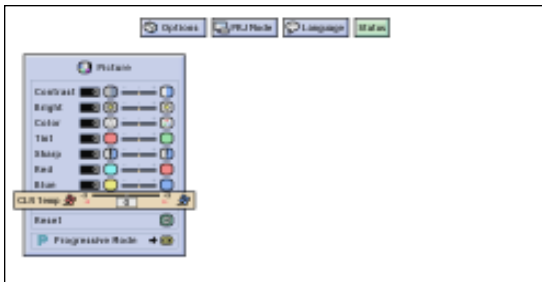

Adjusting the Color Temperature

This function can be used to adjust the color temperature to suit the type of image input to the projector (DVD, video, computer image, TV broadcast, etc.).

This function can be operated using the **CLR TEMP** buttons on the remote control, as well as the GUI menu screen.

Adjusting the Color Temperature with the Remote Control

- 1 Press **CLR TEMP** (-/+) on the remote control. Then, the present color temperature level is displayed.
- 2 Press **CLR TEMP** (-/+) to change the color temperature level.

NOTE

- The descriptions of each of the button operations are shown on the table below.
- "CLR TEMP" disappears after four-seconds of no-operation.

Adjusting the Color Temperature using the GUI Menu Screen

Description of Color Temperature

| | |
|--|--|
| -3 🌸 (Red) ◀ button | ▶ button (Blue) 🌸 +3 |
| Decreases color temperature for warmer, reddish, incandescent-like images. (Low color temperature) | Increases color temperature for cooler, bluish, florescent-like images. (High color temperature) |

- 1 Press **MENU**. Menu bar and "Picture" menu screen appear. GUI operation guide is also displayed.
- 2 Press ▲/▼ to select "CLR Temp".
- 3 Press ◀/▶ to move the ■ mark of the color temperature setting to the desired setting.
- 4 To exit the GUI, press **MENU**.





Adjusting the Picture

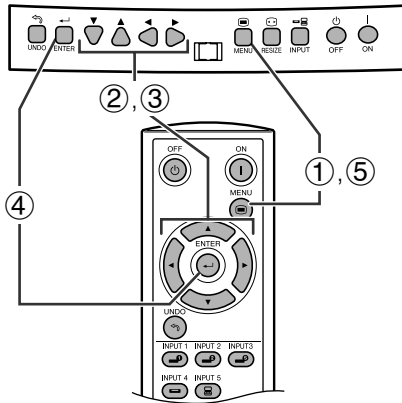

(GUI) On-screen Display

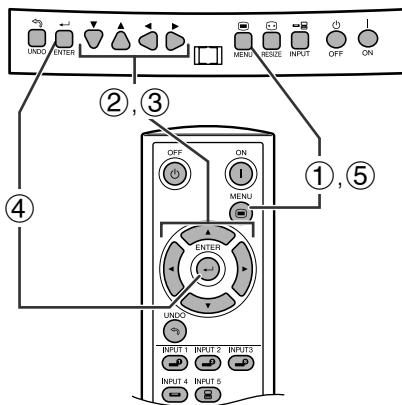
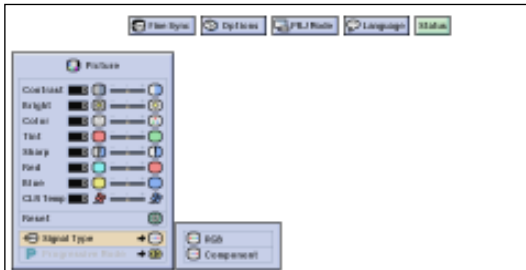

(GUI) On-screen Display

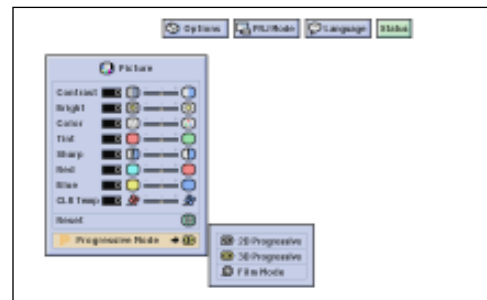

Selecting the Signal Type

This function allows you to select the input signal type COMPONENT or RGB for INPUT 1 or 2.

- ① Press **MENU**. Menu bar and “Picture” menu screen appear. GUI operation guide is also displayed.
- ② Press **▲/▼** to select “Signal Type”, and then press **▶**.
- ③ Press **▲/▼** to select “RGB” or “Component”.
- ④ Press **ENTER** to save the setting.
- ⑤ To exit the GUI, press **MENU**.

Progressive Mode

This function allows you to select the progressive display of a video signal. The progressive display projects a smoother video image.

- ① Press **MENU**. Menu bar and “Picture” menu screen appear. GUI operation guide is also displayed.
- ② Press **▲/▼** to select “Progressive Mode”, and then press **▶**.
- ③ Press **▲/▼** to select “2D Progressive”, “3D Progressive” or “Film Mode”.
- ④ Press **ENTER** to save the setting.
- ⑤ To exit the GUI, press **MENU**.

Selects the following progressive conversion mode.

2D Progressive

This function is useful to display fast-moving images such as sports and action films. This mode optimizes the image in a displayed frame.

3D Progressive

This function is useful to display relatively slow-moving images such as drama and documentary more clearly. This mode optimizes the image by estimating the movement of a number of preceding and succeeding frames.

Film Mode

Reproduces the image of film software clearly. Displays the optimized image of film transformed with three-two pull down enhancement to progressive mode images.

NOTE

- Film Mode cannot work with PAL 50 Hz.





Adjusting the Computer Images (RGB menu only)

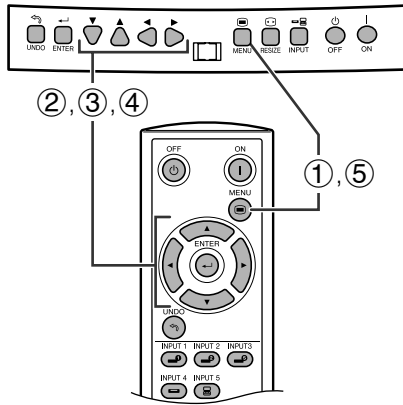

(GUI) On-screen Display

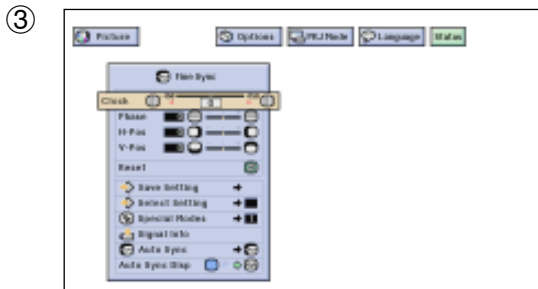
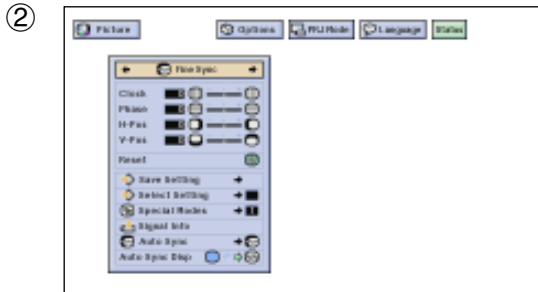

When displaying computer patterns which are very detailed (tiling, vertical stripes, etc.), interference may occur between the DMD pixels, causing flickering, vertical stripes, or contrast irregularities in portions of the screen. Should this occur, adjust “Clock”, “Phase”, “H-Pos” and “V-Pos” for the optimum computer image.

Description of Adjustment Items

| Selected item | Description |
|---------------|--|
| Clock | Adjusts vertical noise. |
| Phase | Adjusts horizontal noise (similar to tracking on your VCR). |
| H-Pos | Centers the on-screen image by moving it to the left or right. |
| V-Pos | Centers the on-screen image by moving it up or down. |
| Reset | All computer image adjustment items are returned to the factory preset settings. |

NOTE

- Computer image adjustments can be made easily by pressing **AUTO SYNC** (🔊) on the remote control. See page 35 for details.

(Select the desired computer input mode with **INPUT 1** or **2**.)

- ① Press **MENU**.
- ② Press **◀/▶** to select “Fine Sync”.
- ③ Press **▲/▼** to select a specific adjustment item.
- ④ Press **◀/▶** to move the **■** mark of the selected adjustment item to the desired setting.
- ⑤ To exit the GUI, press **MENU**.

NOTE

- To reset all adjustment items, select “Reset” on the “Fine Sync” menu screen and press **ENTER**.
- The adjustable area of each item may be changed using the input signal.





Adjusting the Computer Images (RGB menu only)

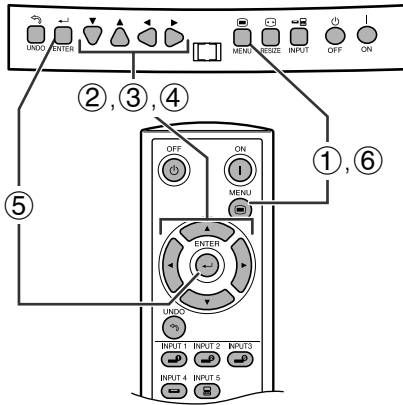

(GUI) On-screen Display

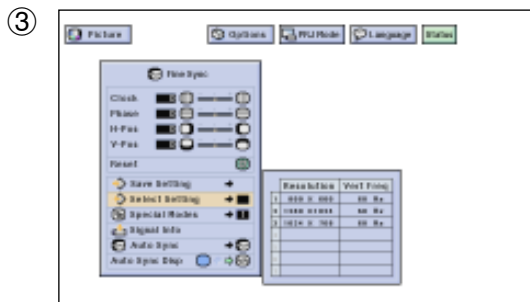
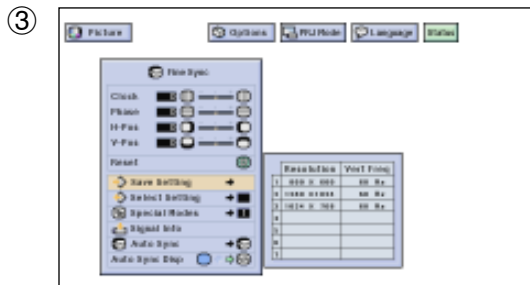
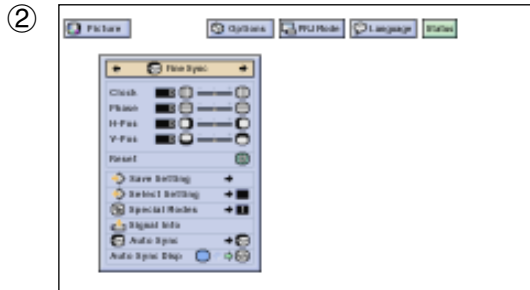

Saving and Selecting Adjustment Settings

This projector allows you to store up to seven adjustment settings for use with various computers. Once these settings are stored, they can be easily selected each time you connect a computer to the projector.

Saving the adjustment setting

- ① Press **MENU**.
- ② Press ◀/▶ to select “Fine Sync”.
- ③ Press ▲/▼ to select “Save Setting”, and then press ▶.
- ④ Press ▲/▼ to select the desired memory location of the setting.
- ⑤ Press **ENTER** to save the setting.
- ⑥ To exit the GUI, press **MENU**.

Selecting a saved setting

- ① Press **MENU**.
- ② Press ◀/▶ to select “Fine Sync”.
- ③ Press ▲/▼ to select “Select Setting”, and then press ▶.
- ④ Press ▲/▼ to select the desired memory setting.
- ⑤ Press **ENTER** to select the setting.
- ⑥ To exit from the GUI, press **MENU**.

NOTE

- If a memory position has not been set, the resolution and frequency setting will not be displayed.
- When selecting the stored adjustment setting with “Select Setting”, the computer system should match the stored setting.



Adjusting the Computer Images (RGB menu only)

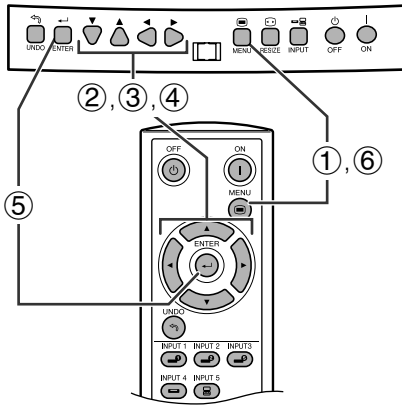

(GUI) On-screen Display

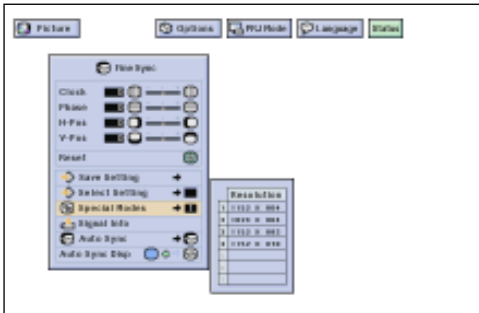

Special Mode Adjustment

Ordinarily, the type of input signal is detected and the correct resolution mode is automatically selected. However, for some signals, the optimal resolution mode in "Special Modes" on the "Fine Sync" menu screen may need to be selected to match the computer display mode.

- ① Press **MENU**.
- ② Press ◀/▶ to select "Fine Sync".
- ③ Press ▲/▼ to select "Special Modes", and then press ▶.
- ④ Press ▲/▼ to select the optimal resolution.
- ⑤ Press **ENTER** to save the setting.
- ⑥ To exit the GUI, press **MENU**.

NOTE

- Avoid displaying computer patterns which repeat every other line (horizontal stripes). (Flickering may occur, making the image hard to see.)
- When inputting DTV 1080i signal, select the corresponding type of signal in step 4 above.

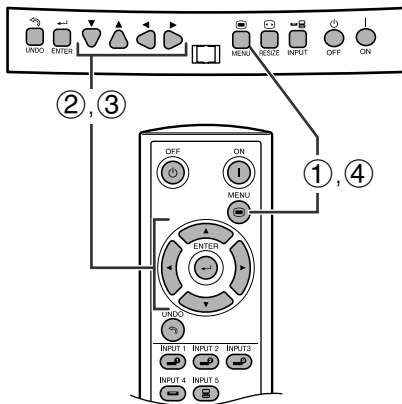

(GUI) On-screen Display

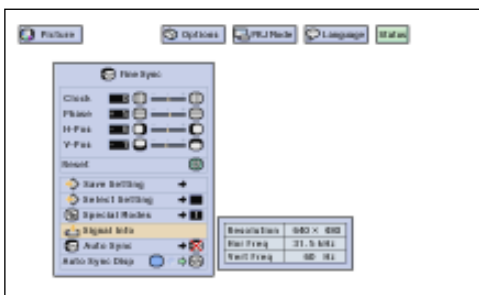

Checking the Input Signal

This function allows you to check the current input signal information.

- ① Press **MENU**.
- ② Press ◀/▶ to select "Fine Sync".
- ③ Press ▲/▼ to select "Signal Info" to display the current input signal.
- ④ To exit the GUI, press **MENU**.





Adjusting the Computer Images (RGB menu only)

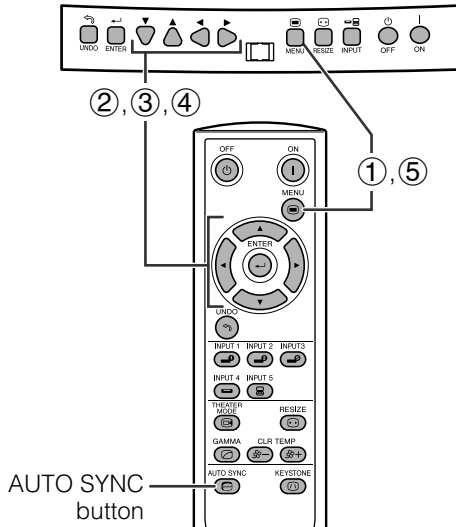

(GUI) On-screen Display

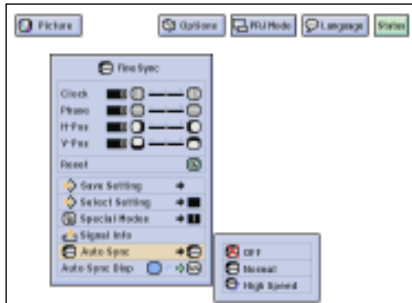

On-screen Display

When "Normal" is selected

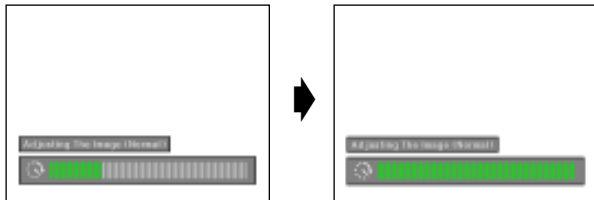

When "High Speed" is selected

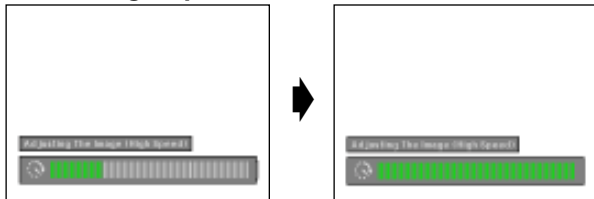

Auto Sync Adjustment

- Used to automatically adjust a computer image.
- Auto Sync adjustment can be made manually by pressing the **AUTO SYNC** button on the remote control, or automatically by setting "Auto Sync" to "Normal" or "High Speed" in the projector's GUI menu.

OFF

- Synchronized adjustment is not automatically performed.
- Press **AUTO SYNC** to perform manual adjustment.

Normal

- Synchronized adjustment is automatically performed the same as the "High Speed" setting.
- Adjustment using the "Normal" setting takes longer to perform than using the "High Speed" setting, but it is more accurate.

High Speed

- The sync adjustment is automatically made each time the projector is turned on while connected to a computer or the input selection is changed.
- The Auto Sync adjustment setting previously made is cleared when the projector's setting is changed.

- ① Press **MENU**.
- ② Press ◀/▶ to select "Fine Sync".
- ③ Press ▲/▼ to select "Auto Sync", and then press ▶.
- ④ Press ▲/▼ to select "Normal" or "High Speed".
- ⑤ To exit the GUI, press **MENU**.

NOTE

- When the optimum image cannot be achieved with Auto Sync adjustment, use manual adjustments. (See page 32.)
- When performing AUTO SYNC in off or High Speed mode, if you press **AUTO SYNC** once, then press it again within one minute, AUTO SYNC will be executed in Normal mode.

During Auto Sync adjustment, the On-screen Display changes as shown on the left.

NOTE

- The Auto Sync adjustment may take some time to complete, depending on the image of the computer connected to the projector.





Adjusting the Computer Images (RGB menu only)

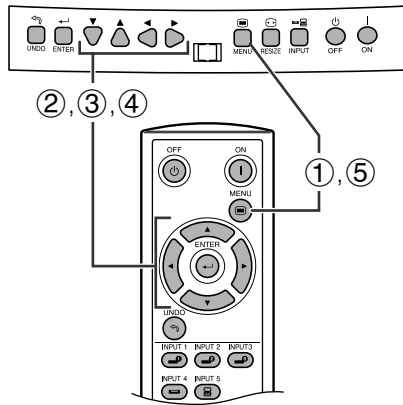

(GUI) On-screen Display

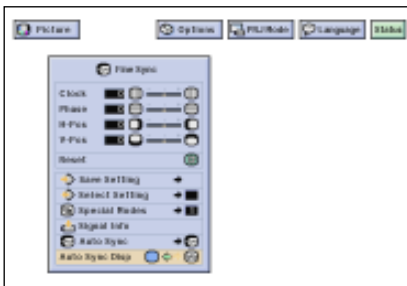

Auto Sync Display Function

Normally, an image is not superimposed during Auto Sync adjustment. You can, however, choose to superimpose a background image during Auto Sync adjustment.

- ① Press **MENU**.
- ② Press ◀/▶ to select "Fine Sync".
- ③ Press ▲/▼ to select "Auto Sync Disp".
- ④ Press ◀/▶ to select "☐" to superimpose a background image or "Ⓜ" to remove the background image during Auto Sync adjustment.
- ⑤ To exit the GUI, press **MENU**.



Reducing Image Noise (VIDEO menu only)

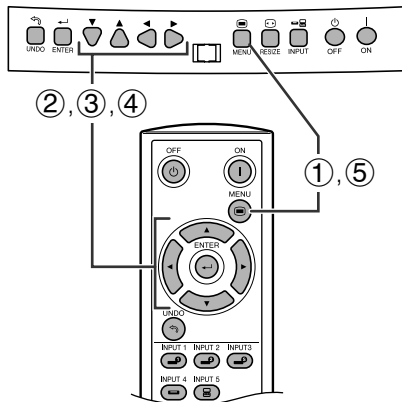

(GUI) On-screen Display



3D Digital Noise Reduction (3D DNR) provides high quality images with minimal background.

- ① Press **MENU**.
- ② Press ◀/▶ to select "Options".
- ③ Press ▲/▼ to select "3D DNR".
- ④ Press ◀/▶ to select "☐" (ON).
- ⑤ To exit the GUI, press **MENU**.

NOTE

- If the image is clear, select "☐" (OFF) to prevent any blurring.





Turning On/Off the On-screen Display

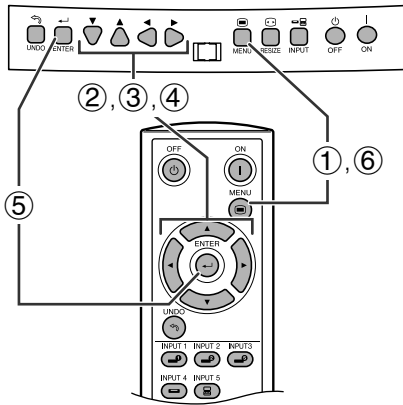

(GUI) On-screen Display

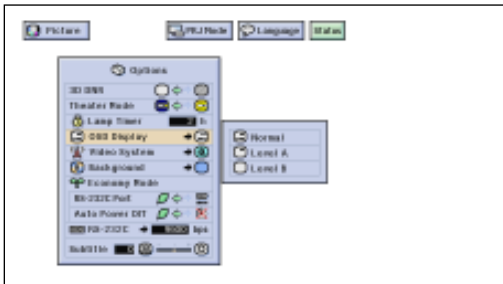

This function allows you to turn on or off the on-screen messages that appear during input select.

Description of OSD Display

| Selected item | Description |
|---------------|--|
| Normal | All On-screen Display are displayed. |
| Level A | INPUT and AUTO SYNC are not displayed. |
| Level B | All On-screen Display are not displayed (except MENU, KEYSTONE and warning display (Power off, Temp., Lamp etc.)). |

- ① Press **MENU**.
- ② Press ◀/▶ to select "Options".
- ③ Press ▲/▼ to select "OSD Display", and then press ▶.
- ④ Press ▲/▼ to select the desired On-screen Display.
- ⑤ Press **ENTER** to save the setting.
- ⑥ To exit the GUI, press **MENU**.



Setting the Video Signal (VIDEO menu only)

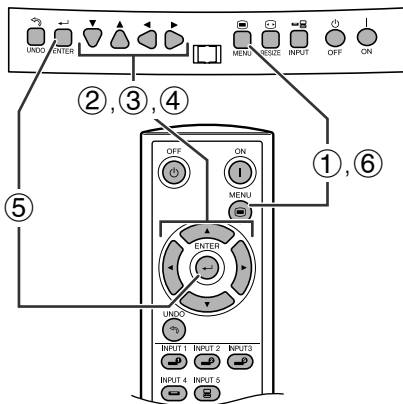

(GUI) On-screen Display

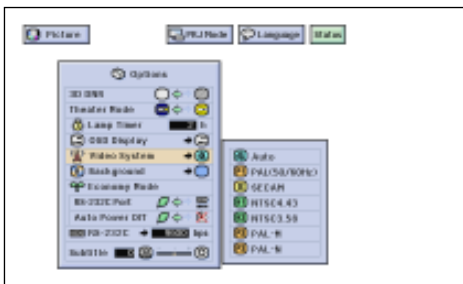

The video input system mode is preset to "Auto"; however, it can be changed to a specific system mode if the selected system mode is not compatible with the connected audiovisual equipment.

- ① Press **MENU**.
- ② Press ◀/▶ to select "Options".
- ③ Press ▲/▼ to select "Video Systems", and then press ▶.
- ④ Press ▲/▼ to select the desired video system mode.
- ⑤ Press **ENTER** to save the setting.
- ⑥ To exit the GUI, press **MENU**.

NOTE

- When the system mode is set to "Auto", you may not receive a clear picture due to signal differences. Should this occur, switch to the video system of the source signal.
- AUTO cannot be set for PAL-M and PAL-N input signals. Select "PAL-M" or "PAL-N" in "Video System" menu for PAL-M and PAL-N input signals.



Theater Mode Functions

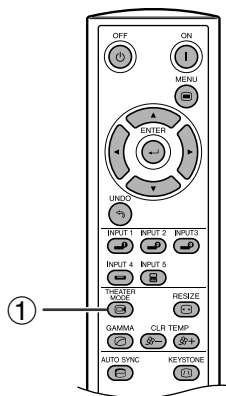

On-screen Display

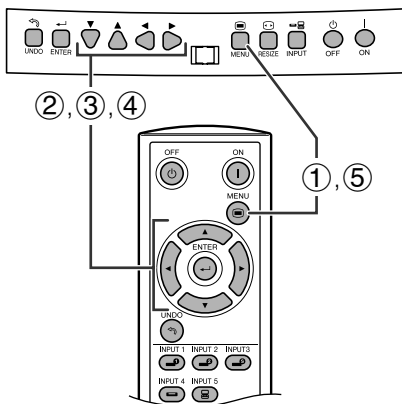

(GUI) On-screen Display

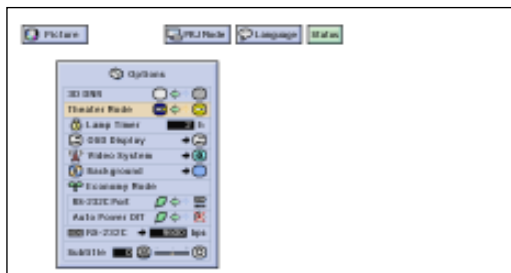

Function as a toggle switch for controlling the quantity of projected light. Select “NORMAL” or “BRIGHT” to decrease or increase brightness, power consumption and fan noise.

This function can be operated using the **THEATER MODE** button on the remote control, as well as the GUI menu screen.

Description of Theater Modes

| Selected item | Description |
|--------------------|---|
| NORMAL (🇺🇸) | Quantity of light is 70%. Power consumption is 310 W. |
| BRIGHT (🇯🇵) | Quantity of light is 100%. Power consumption is 365 W. |

Operating the Theater Mode Function with the Remote Control

- 1 Press **THEATER MODE** on the remote control. The present Theater Mode is displayed.
“**THEATER MODE**” disappears after four-seconds of no-operation.

NOTE

- “Theater Mode” is factory preset to “BRIGHT” .
- When selecting “BRIGHT” in “Theater Mode”, the fan noise is increased.
- Even when selecting “NORMAL” in “Theater Mode”, fan noise may increase if internal temperature rises enough to activate the cooling function.

Operating the Theater Mode Function Using the GUI Menu Screen

- 1 Press **MENU**.
- 2 Press **◀/▶** to select “Options”.
- 3 Press **▲/▼** to select “Theater Mode”.
- 4 Press **◀/▶** to select “🇺🇸” or “🇯🇵”.
- 5 To exit the GUI, press **MENU**.





Selecting a Background Image

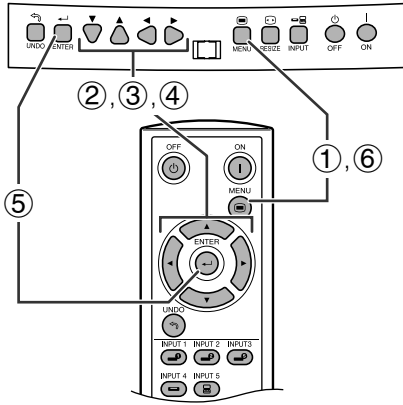

(GUI) On-screen Display



This function allows you to select the image displayed when no signal is being sent to the projector.

Description of Background Images

| Selected item | Description |
|---------------|--------------|
| Blue | Blue screen |
| None | Black screen |

- ① Press **MENU**.
- ② Press ◀/▶ to select "Options".
- ③ Press ▲/▼ to select "Background", and then press ▶.
- ④ Press ▲/▼ to select the background image you want to display on the screen.
- ⑤ Press **ENTER** to save the setting.
- ⑥ To exit the GUI, press **MENU**.





Subtitle Setting

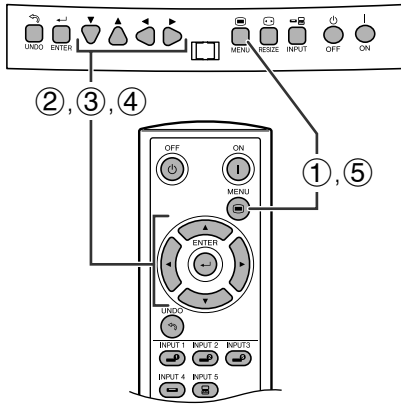

(GUI) On-screen Display

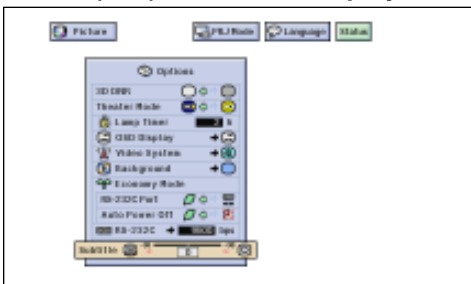

With this function, you can adjust the vertical size of the display to allow for subtitles.

Description of Subtitle Setting

| | | | | |
|--|-----|--|-----|--|
| | -30 | | +30 | |
| button | | button | | |
| Compresses the image to adjust the vertical size of the display. | | Enlarges the image to adjust the vertical size of the display. | | |

- ① Press **MENU**.
- ② Press ◀/▶ to select "Options".
- ③ Press ▲/▼ to select "Subtitle".
- ④ Press ◀/▶ to move the ■ mark of the subtitle setting.
- ⑤ To exit the GUI, press **MENU**.

NOTE

- The RESIZE modes that are available for the Subtitle setting are SMART STRETCH and CINEMA ZOOM only. Please refer to the page 24 for details.
- The value of the Subtitle setting may be changed using the INPUT and RESIZE mode.
- When changing the screen with the Subtitle setting, not only the bottom of the screen rises up but also the upper side is changed to a certain point.

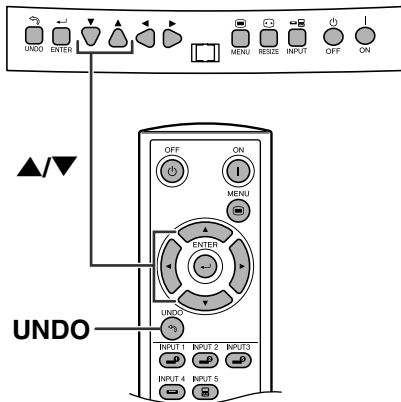

Digital shift

When the normal image is projected (without the menu screen or most On-screen Displays* displayed), ▲/▼ can be used to shift the image down or up. Press **UNDO** to return the image center.

* This function does not work when most On-screen Displays are displayed. However, it can be used when "INPUT 1", "INPUT 2", "INPUT 3", "INPUT 4" or "INPUT 5" appears on the screen.

NOTE

- This function only works with certain picture mode displays.

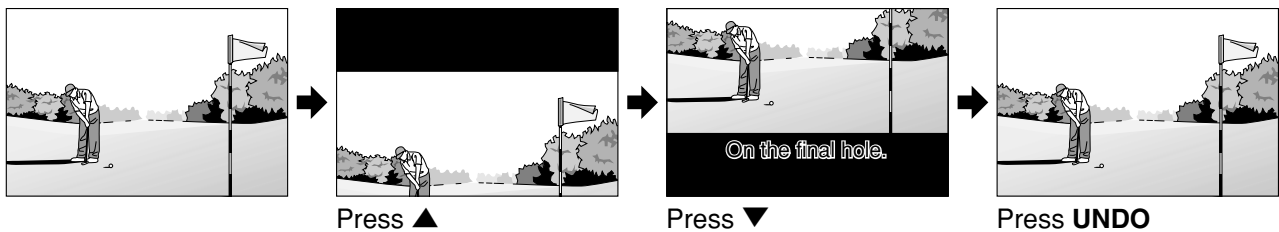



Selecting the Economy Mode

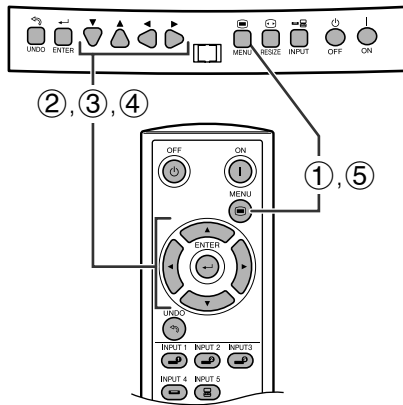

(GUI) On-screen Display



On-screen Display



(GUI) On-screen Display

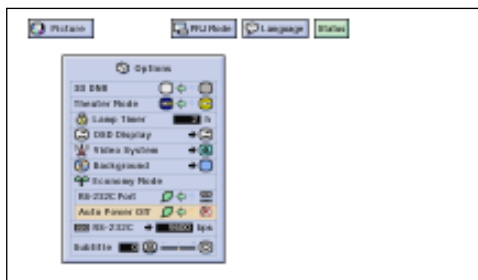

These functions allow you to reduce the power consumption when the projector is in stand-by mode.

RS-232C Off Function

This projector consumes power when using a computer connected to the RS-232C port. When not using this port, "RS-232C Port" can be set to "🌿" for reducing stand-by power consumption.

Description of RS-232C Off

| | |
|--|---|
| | Stand-by power for RS-232C connection turned off. |
| | RS-232C on |

- 1 Press **MENU**.
- 2 Press ◀/▶ to select "Options".
- 3 Press ▲/▼ to select "RS-232C Port".
- 4 Press ◀/▶ to select "🌿" or "🖨️".
- 5 To exit the GUI, press **MENU**.

NOTE

- Set "RS-232C Port" to "🖨️" when using the SharpVision Manager (supplied).

Automatic Power Shut-off Function

When no input signal is detected for more than 15 minutes, the projector will automatically shut off. The on-screen message on the left will appear five minutes before the power is automatically turned off.

Description of Automatic Power Shut-off

| | |
|--|---|
| | Power automatically shuts off after 15 minutes without an input signal. |
| | Automatic Power Shut-off disabled. |

- 1 Press **MENU**.
- 2 Press ◀/▶ to select "Options".
- 3 Press ▲/▼ to select "Auto Power Off".
- 4 Press ◀/▶ to select "🌿" or "🖨️".
- 5 To exit the GUI, press **MENU**.

NOTE

- "RS-232C Port" is factory preset to "🖨️", and "Auto Power Off" is factory preset to "🌿".





Selecting the Transmission Speed (RS-232C)

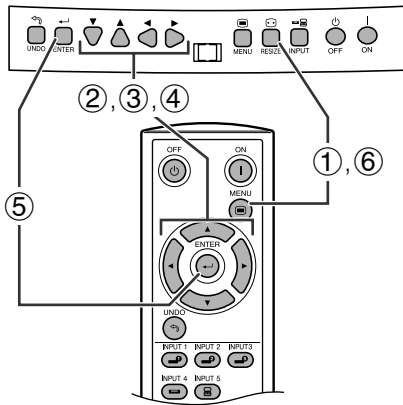

(GUI) On-screen Display

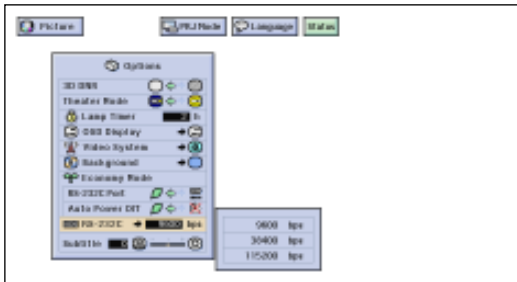

This menu allows you to adjust the transmission speed of the RS-232C connection by selecting the baud rate.

- ① Press **MENU**.
- ② Press ◀/▶ to select "Options".
- ③ Press ▲/▼ to select "RS-232C", and then press ▶.
- ④ Press ▲/▼ to select the desired baud rate.
- ⑤ Press **ENTER** to save the setting.
- ⑥ To exit the GUI, press **MENU**.

NOTE

- Make sure that both the projector and computer are set for the same baud rate. Refer to the computer's operation manual for instructions for setting the baud rate.





Reversing/Inverting Projected Images

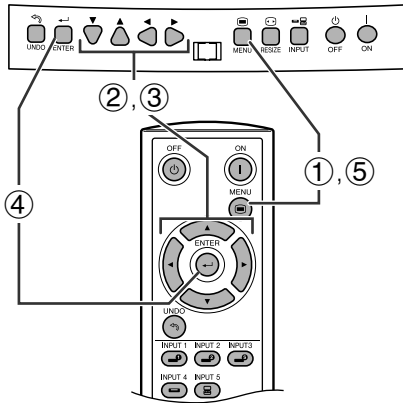

(GUI) On-screen Display



This projector is equipped with a reverse/invert image function which allows you to reverse or invert the projected image for various applications.

Description of Projected Images

| Selected item | Description |
|-----------------|-----------------------------|
| Front | Normal image |
| Ceiling + Front | Inverted image |
| Rear | Reversed image |
| Ceiling + Rear | Reversed and inverted image |

- ① Press **MENU**.
- ② Press ◀/▶ to select "PRJ Mode".
- ③ Press ▲/▼ to select the desired projection mode.
- ④ Press **ENTER** to save the setting.
- ⑤ To exit the GUI, press **MENU**.

NOTE

- This function is used for the reversed image and ceiling-mount setups. See page 22 for these setups.



Selecting the On-screen Display Language

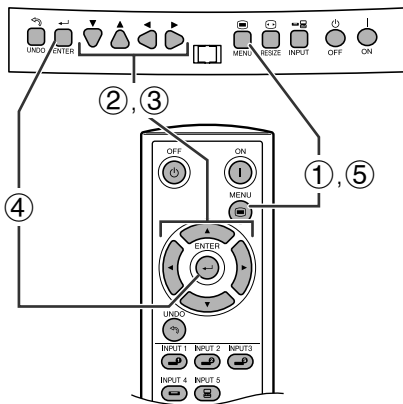

(GUI) On-screen Display

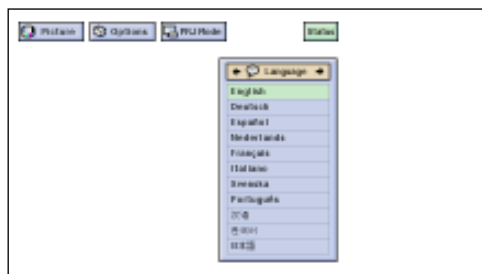

English is the preset language for the On-screen Display; however, this can be changed to German, Spanish, Dutch, French, Italian, Swedish, Portuguese, Chinese, Korean or Japanese.

- ① Press **MENU**.
- ② Press ◀/▶ to select "Language".
- ③ Press ▲/▼ to select the desired language.
- ④ Press **ENTER** to save the setting. The On-screen Display is now programmed to display in the language selected.
- ⑤ To exit the GUI, press **MENU**.



Displaying the Adjustment Settings

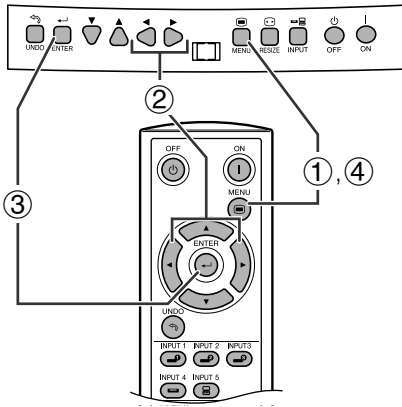

This function can be used to display all the adjusted settings on the screen simultaneously.

- ① Press **MENU**.
- ② Press **◀/▶** to select "Status".
- ③ Press **ENTER** to display all the adjustment settings.
- ④ To exit the GUI, press **MENU**.

(GUI) On-screen Display

INPUT 3, 4 (VIDEO) mode

②



③

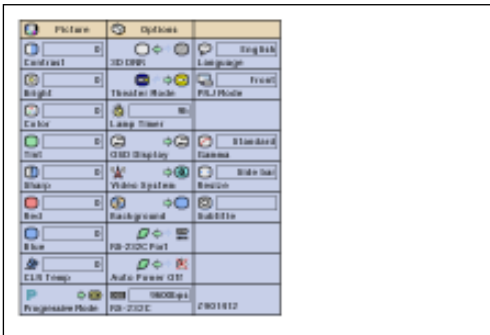

INPUT 1, 2 (COMPONENT) or 5 (RGB) mode

②



③

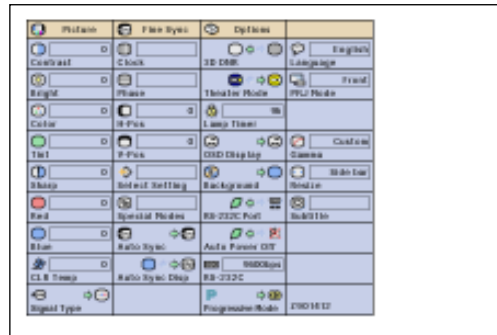



Lamp/Maintenance Indicators

Maintenance Indicators

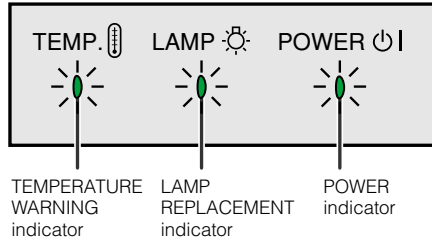

- The warning lights on the projector indicate problems inside the projector.
- There are two types of warning lights: a TEMPERATURE WARNING indicator that warns you when the projector is too hot, and a LAMP REPLACEMENT indicator that warns you when to change the lamp.
- If a problem occurs, either the TEMPERATURE WARNING indicator or the LAMP REPLACEMENT indicator will light up red. After turning off the power, follow the procedures given below.

| Maintenance Indicator | Condition | Problem | Possible Solution |
|-------------------------------|--|---|---|
| TEMPERATURE WARNING indicator | The internal temperature is abnormally high. | • Blocked air intake. | • Relocate the projector to an area with proper ventilation. |
| | | • Clogged air filter. | • Clean the filters. (See page 49.) |
| | | • Cooling fan breakdown. • Internal circuit failure. | • Take the projector to your nearest Authorized SharpVision or Service Center or Dealer for repair. |
| LAMP REPLACEMENT indicator | The lamp does not light up. | • Burnt-out lamp. • Lamp circuit failure. | • Carefully replace the lamp. (See page 48.) • Take the projector to your nearest Authorized Sharp Vision Service Center or Dealer for repair. |
| | The lamp requires replacement. | • Lamp has been used for over 1,900 hours. | |

NOTE

- If the TEMPERATURE WARNING indicator lights up, follow the above possible solutions and then wait until the projector has cooled down completely before turning the power back on. (At least 5 minutes.)
- If the power is turned off and then turned on again, for example during a brief rest, the LAMP REPLACEMENT indicator may be triggered, preventing the power from going on. Should this occur, unplug the power cord from the wall outlet and plug it back in again.





Lamp Maintenance



Confirming the Lamp Usage Time

The lamp in this projector operates for approximately 2,000 cumulative hours, depending on the usage environment. (As the usage environment can vary significantly, the projector lamp may not operate for 2,000 hours.) It is recommended that the lamp be replaced after approximately 1,900 cumulative hours of use or when you notice a significant deterioration of the picture and color quality. The lamp usage time can be checked with the On-screen Display.

CAUTION

- Intense light hazard. Do not attempt to look into the aperture and lens while the projector is operating.

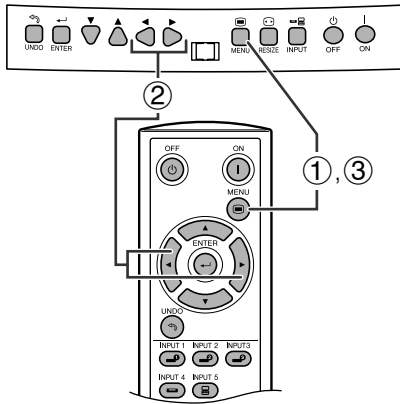

This function allows you to check the accumulated lamp usage time.

- ① Press **MENU**.
- ② Press **◀/▶** to select "Options". The lamp usage time will be displayed in the "Lamp Timer" of "Options".
- ③ To exit the GUI, press **MENU**.

NOTE

- It is recommended that the lamp be replaced after approximately 1,900 cumulative hours of use. See page 48 for lamp replacement.

(GUI) On-screen Display

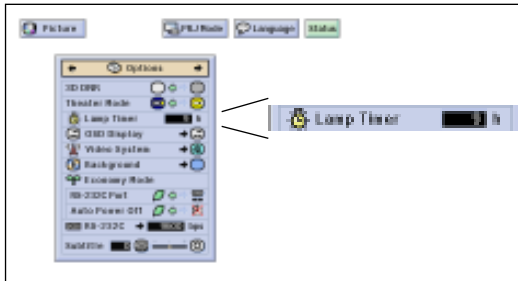

| Condition | Problem | Possible Solution |
|--|--|---|
| The LAMP REPLACEMENT indicator lights up red, and "LAMP" and "■" will flash in yellow in the lower-left corner of the picture. | <ul style="list-style-type: none"> • Lamp has been used for over 1,900 hours. | <ul style="list-style-type: none"> • Purchase a replacement lamp unit (lamp/cage module) of the current type BQC-XVZ9000/1 from your nearest Authorized SharpVision Service Center or Dealer. • Replace the lamp. (See page 48.) If you wish, you may have the lamp replaced at your nearest Authorized SharpVision Service Center or Dealer. |
| A significant deterioration of the picture and color quality occurs. | | |
| The power will automatically turn off and the projector will enter stand-by mode. | <ul style="list-style-type: none"> • Lamp has been used for over 2,000 hours. | |
| "LAMP" and "■" will flash in red in the lower-left corner of the picture, and the power will turn off. | | |





Replacing the Lamp

CAUTION

- There is potential glass particles hazard if the lamp ruptures. In case of lamp rupture, contact your nearest Authorized SharpVision Service Center or Dealer for replacement.
- Do not remove the lamp cage directly after operation of the projector. The lamp may be extremely hot. Wait at least one hour after the power cord is disconnected to allow the surface of the lamp cage to fully cool down before removing the lamp cage.

It is recommended that the lamp be replaced after approximately 1,900 cumulative hours of use or when you notice a significant deterioration of the picture and color quality. Carefully change the lamp by following the steps on the next page.

If the new lamp does not light after replacement, take your projector to the nearest Authorized SharpVision Service Center or Dealer for repair. Purchase a replacement lamp unit (lamp/cage module) of the current type BQC-XVZ9000/1 from your nearest Authorized SharpVision Service Center or Dealer. Then carefully change the lamp by following the instructions on the next page. If you wish, you may have the lamp replaced at your nearest Authorized SharpVision Service Center.

IMPORTANT NOTE TO U.S. CUSTOMERS:

The lamp included with this projector is backed by a 90-day parts and labor limited warranty. All service of this projector under warranty, including lamp replacement, must be obtained through an Authorized SharpVision Service Center or Dealer. For the name of the nearest Authorized SharpVision Service Center or Dealer, please call toll-free: 1-877-DTV-SHARP (1-877-388-7427).

U.S.A. ONLY





Replacing the Lamp

Removing and installing the lamp unit

CAUTION

- Be sure to remove the lamp cage by the handle. Do not touch the glass surface of the lamp cage or the inside of the projector.
- To avoid injury to yourself and damage to the lamp, carefully follow the steps below.
- Replace the lamp after turning off the power and unplugging the power cord.

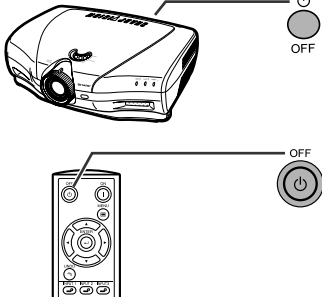
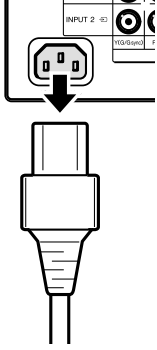
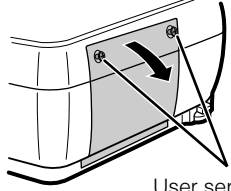
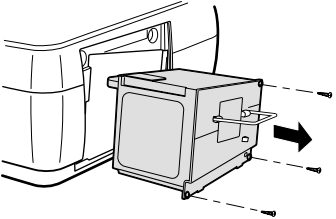
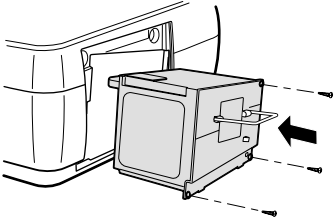
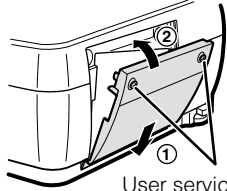
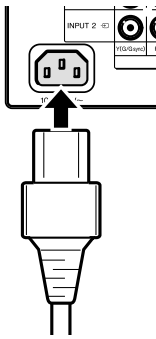
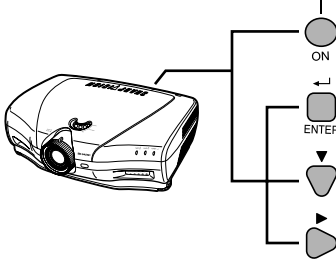
| | | |
|--|--|---|
| <p>1 Turn off the power.</p> <p>Press POWER OFF. Wait until the cooling fan stops running.</p>  | <p>2 Unplug the power cord.</p>  | <p>3 Remove the lamp cage cover.</p> <p>Loosen the user service screw that secures the lamp cage cover on the side of the projector. Then lower the cover in the direction of the arrow (to the open mark).</p>  <p>User service screws</p> |
| <p>4 Remove the lamp cage.</p> <p>Remove the three-securing screws from the lamp cage. Hold the lamp cage by the handle and pull it horizontally towards you.</p>  | <p>5 Insert the new lamp cage.</p> <p>Press the lamp cage firmly into the lamp cage compartment. Fasten the three-securing screws.</p>  | <p>6 Attach the lamp cage cover.</p> <p>Close the lamp cage cover in the direction of the arrow (to the close mark) on the side of the projector. Then tighten the user service screw.</p>  <p>User service screws</p> |
| <p>7 Plug in the power cord.</p>  | <p>8 Press POWER ON on projector to reset lamp timer.</p> <p>While holding down ENTER, ▼ and ►, press POWER ON.</p>  | |

NOTE

- You need to reset lamp timer every time when replacing the lamp and confirm it to be reset on "Lamp Timer" menu.





Cleaning the Air Filters

- This projector is equipped with air filters to ensure the optimal operating condition of the projector.
- Periodically clean the air filter by vacuuming it off with a vacuum cleaner.
- The air filter should be cleaned every 100 hours of use. Clean the filters more often when the projector is used in a dirty or smoky location.

Side and Rear view

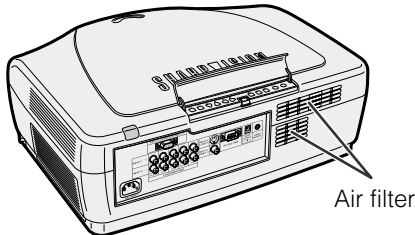

Bottom view

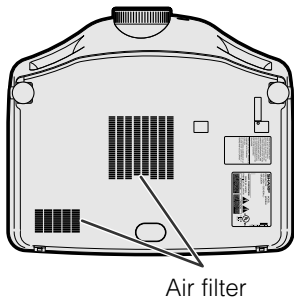

How to clean the air filter

| | |
|--|--|
| <p>1 Unplug the power cord.</p> | <p>2 Cleaning.</p> |
| | <p>Clean the dust off by putting the cleaner hose on the intake ventilative hole of the air filters.</p> <p>Cleaner hose</p> <p>Cleaner hose</p> |



Using the Kensington Lock

Side view

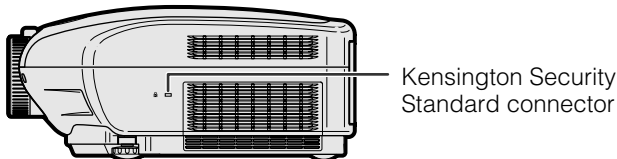

This projector has a Kensington Security Standard connector for use with a Kensington MicroSaver Security System. Refer to the information that came with the system for instructions on how to use it to secure the projector.





Troubleshooting

| Problem | Check |
|--|--|
| No picture appears. | <ul style="list-style-type: none"> • Projector power cord is not plugged into the wall outlet. • Selected input is wrong. (See page 23.) • Cables incorrectly connected to back panel of the projector. (See pages 13–15.) • Remote control batteries have run down. (See page 11.) • “Contrast” and “Brightness” adjustments are set to minimum position. (See page 29.) |
| Color is faded or poor. | <ul style="list-style-type: none"> • “Color” and “Tint” adjustments are not correct. (See page 29.) |
| Picture is blurred. | <ul style="list-style-type: none"> • Adjust the focus. (See page 17.) • Projection distance is too long or too short to allow for proper focus. (See pages 20 and 21.) |
| No OSD appears. | <ul style="list-style-type: none"> • OSD Display is set to “Level A” or “Level B”, preventing to display some or all On-screen Displays. (See page 37.) |
| An unusual sound is occasionally heard from the cabinet. | <ul style="list-style-type: none"> • If the picture is normal, the sound is due to cabinet shrinkage caused by temperature changes. This will not affect operation or performance. |
| Maintenance indicator lights up. | <ul style="list-style-type: none"> • Refer to “Lamp/Maintenance Indicators” on page 45. |
| Picture noise appears. | <ul style="list-style-type: none"> • Adjust the “Phase” setting. (See page 32.) • Noise may appear when used with certain computers. Set the NOISE FILTER to ON using the RS-232C command. (See pages 52–54.) |
| Image is green on INPUT 1 or 2 COMPONENT. Image is pink (no green) on INPUT 1, 2 RGB. | <ul style="list-style-type: none"> • Change the input signal type. (See page 31.) |



For SHARP Assistance (U.S.A. only)

If you encounter any problems during setup or operation of this projector, first refer to the “Troubleshooting” section on this page. If this operation manual does not answer your question, please call toll free 1-877-DTV-SHARP (1-877-388-7427) for further assistance. Or, send us an e-mail at lcdsupport@sharpsec.com . Our World Wide Web address is <http://www.sharp-usa.com/> .





Connecting Pin Assignments

INPUT 5 RGB Signal Input Port: 15-pin Mini D-sub female connector

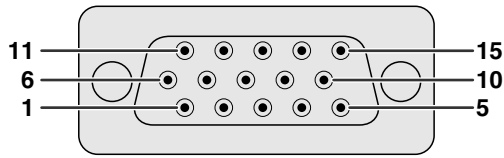

RGB Input

Analog

- | | |
|--------------------------------------|----------------------------|
| 1. Video input (red) | 8. Earth (blue) |
| 2. Video input (green/sync on green) | 9. Not connected |
| 3. Video input (blue) | 10. GND |
| 4. Not connected | 11. GND |
| 5. Composite sync | 12. Bi-directional data |
| 6. Earth (red) | 13. Horizontal sync signal |
| 7. Earth (green/sync on green) | 14. Vertical sync signal |
| | 15. Data clock |

RS-232C Port: 9-pin D-sub male connector of the DIN-D-sub RS-232C cable

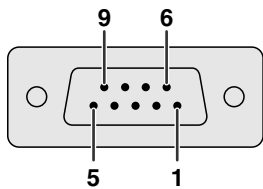

| Pin No. | Signal | Name | I/O | Reference |
|---------|--------|---------------|--------|-------------------------------|
| 1 | | | | Not connected |
| 2 | RD | Receive Data | Input | Connected to internal circuit |
| 3 | SD | Send Data | Output | Connected to internal circuit |
| 4 | | Reserved | | Connected to internal circuit |
| 5 | SG | Signal Ground | | Connected to internal circuit |
| 6 | | Reserved | | Connected to internal circuit |
| 7 | | Reserved | | Connected to internal circuit |
| 8 | | Reserved | | Connected to internal circuit |
| 9 | | | | Not connected |





(RS-232C) Specifications and Command Settings

PC control

A computer can be used to control the projector by connecting an RS-232C cable (null modem, cross type, commercially available) to the projector. (See page 15 for connection.)

Communication conditions

Set the serial port settings of the computer to match those of the table on the next page.

Signal format: Conforms to RS-232C standard.

Baud rate: 9,600 bps

Data length: 8 bits

Parity bit: NON

Stop bit: 1 bit

Flow control: None

Basic format

Commands from the computer are sent in the following order: command, parameter, and return code. After the projector processes the command from the computer, it sends a response code to the computer.

Command format

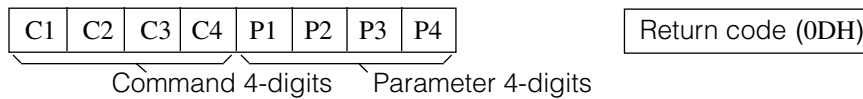

Response code format

Normal response



Problem response (communication error or incorrect command)



When more than one code is being sent, send each command only after the OK response code for the previous command from the projector is verified.

NOTE

- When using the computer control function of the projector, the projector operating status cannot be read to the computer. Therefore, confirm the status by transmitting the display commands for each adjustment menu and checking the status with the On-screen Display. If the projector receives a command other than a menu display command, it will execute the command without displaying the On-screen Display.

Commands

EXAMPLE

- When "Brightness" of INPUT 1 Picture Adjustment is set to -10.

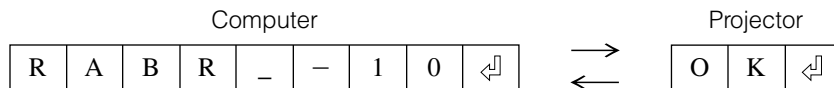



(RS-232C) Specifications and Command Settings

| | CONTROL CONTENTS | COMMAND | PARAMETER | RETURN |
|--|---|---------|-----------|-----------|
| BUTTONS & REMOTE CONTROL KEY | POWER ON | P O W R | - - - 1 | OK OR ERR |
| | POWER OFF | P O W R | - - - 0 | OK OR ERR |
| | KEYSTONE (- 127 - + 127) | K E Y S | * * * * | OK OR ERR |
| | INPUT 1 (COMPONENT 1) | I R G B | - - - 1 | OK OR ERR |
| | INPUT 2 (COMPONENT 2) | I R G B | - - - 2 | OK OR ERR |
| | INPUT 3 (S-VIDEO) | I V E D | - - - 2 | OK OR ERR |
| | INPUT 4 (VIDEO) | I V E D | - - - 1 | OK OR ERR |
| | INPUT 5 (COMPUTER-RGB) | I R G B | - - - 3 | OK OR ERR |
| | AUTO SYNC START | A D J S | - - - 1 | OK OR ERR |
| | INPUT 1 (COMPONENT 1) RESIZE : SIDE BAR | R A S R | - - - 3 | OK OR ERR |
| | INPUT 1 (COMPONENT 1) RESIZE : SMART STRETCH | R A S R | - - - 4 | OK OR ERR |
| | INPUT 1 (COMPONENT 1) RESIZE : CINEMA ZOOM | R A S R | - - - 1 | OK OR ERR |
| | INPUT 1 (COMPONENT 1) RESIZE : STRETCH | R A S R | - - - 2 | OK OR ERR |
| | INPUT 2 (COMPONENT 2) RESIZE : SIDE BAR | R B S R | - - - 3 | OK OR ERR |
| | INPUT 2 (COMPONENT 2) RESIZE : SMART STRETCH | R B S R | - - - 4 | OK OR ERR |
| | INPUT 2 (COMPONENT 2) RESIZE : CINEMA ZOOM | R B S R | - - - 1 | OK OR ERR |
| | INPUT 2 (COMPONENT 2) RESIZE : STRETCH | R B S R | - - - 2 | OK OR ERR |
| | INPUT 3 (S-VIDEO) RESIZE : SIDE BAR | R B S V | - - - 3 | OK OR ERR |
| | INPUT 3 (S-VIDEO) RESIZE : SMART STRETCH | R B S V | - - - 4 | OK OR ERR |
| | INPUT 3 (S-VIDEO) RESIZE : CINEMA ZOOM | R B S V | - - - 1 | OK OR ERR |
| INPUT 3 (S-VIDEO) RESIZE : STRETCH | R B S V | - - - 2 | OK OR ERR | |
| INPUT 4 (VIDEO) RESIZE : SIDE BAR | R A S V | - - - 3 | OK OR ERR | |
| INPUT 4 (VIDEO) RESIZE : SMART STRETCH | R A S V | - - - 4 | OK OR ERR | |
| INPUT 4 (VIDEO) RESIZE : CINEMA ZOOM | R A S V | - - - 1 | OK OR ERR | |
| INPUT 4 (VIDEO) RESIZE : STRETCH | R A S V | - - - 2 | OK OR ERR | |
| INPUT 5 (COMPUTER-RGB) RESIZE : NORMAL | R C S R | - - - 1 | OK OR ERR | |
| INPUT 5 (COMPUTER-RGB) RESIZE : DOT BY DOT | R C S R | - - - 3 | OK OR ERR | |
| RGB GAMMA : STANDARD | G A M R | - - - 1 | OK OR ERR | |
| RGB GAMMA : GAMMA1 | G A M R | - - - 2 | OK OR ERR | |
| RGB GAMMA : GAMMA2 | G A M R | - - - 3 | OK OR ERR | |
| RGB GAMMA : CUSTOM | G A M R | - - - 4 | OK OR ERR | |
| VIDEO GAMMA : STANDARD | G A M V | - - - 1 | OK OR ERR | |
| VIDEO GAMMA : GAMMA1 | G A M V | - - - 2 | OK OR ERR | |
| VIDEO GAMMA : GAMMA2 | G A M V | - - - 3 | OK OR ERR | |
| VIDEO GAMMA : CUSTOM | G A M V | - - - 4 | OK OR ERR | |
| PICTURE | INPUT 1 (COMPONENT 1) CONTRAST (- 30 - + 30) | R A P I | * * * * | OK OR ERR |
| | INPUT 1 (COMPONENT 1) BRIGHTNESS (- 30 - + 30) | R A B R | * * * * | OK OR ERR |
| | INPUT 1 (COMPONENT 1) RED (- 30 - + 30) | R A R D | * * * * | OK OR ERR |
| | INPUT 1 (COMPONENT 1) BLUE (- 30 - + 30) | R A B E | * * * * | OK OR ERR |
| | INPUT 1 (COMPONENT 1) COLOR (- 30 - + 30) | R A C O | * * * * | OK OR ERR |
| | INPUT 1 (COMPONENT 1) TINT (- 30 - + 30) | R A T I | * * * * | OK OR ERR |
| | INPUT 1 (COMPONENT 1) SHARP (- 30 - + 30) | R A S H | * * * * | OK OR ERR |
| | INPUT 1 (COMPONENT 1) CLR TEMP (- 3 - + 3) | R A C T | - - - * | OK OR ERR |
| | INPUT 1 (COMPONENT 1) DISPLAY | R A R E | - - - 0 | OK OR ERR |
| | INPUT 1 (COMPONENT 1) ADJUSTMENT RESET | R A R E | - - - 1 | OK OR ERR |
| | INPUT 2 (COMPONENT 2) CONTRAST (- 30 - + 30) | R B P I | * * * * | OK OR ERR |
| | INPUT 2 (COMPONENT 2) BRIGHTNESS (- 30 - + 30) | R B B R | * * * * | OK OR ERR |
| | INPUT 2 (COMPONENT 2) RED (- 30 - + 30) | R B R D | * * * * | OK OR ERR |
| | INPUT 2 (COMPONENT 2) BLUE (- 30 - + 30) | R B B E | * * * * | OK OR ERR |
| | INPUT 2 (COMPONENT 2) COLOR (- 30 - + 30) | R B C O | * * * * | OK OR ERR |
| | INPUT 2 (COMPONENT 2) TINT (- 30 - + 30) | R B T I | * * * * | OK OR ERR |
| | INPUT 2 (COMPONENT 2) SHARP (- 30 - + 30) | R B S H | * * * * | OK OR ERR |
| | INPUT 2 (COMPONENT 2) CLR TEMP (- 3 - + 3) | R B C T | - - - * | OK OR ERR |
| | INPUT 2 (COMPONENT 2) DISPLAY | R B R E | - - - 0 | OK OR ERR |
| | INPUT 2 (COMPONENT 2) ADJUSTMENT RESET | R B R E | - - - 1 | OK OR ERR |
| | INPUT 5 (COMPUTER-RGB) CONTRAST (- 30 - + 30) | R C P I | * * * * | OK OR ERR |
| | INPUT 5 (COMPUTER-RGB) BRIGHTNESS (- 30 - + 30) | R C B R | * * * * | OK OR ERR |
| | INPUT 5 (COMPUTER-RGB) RED (- 30 - + 30) | R C R D | * * * * | OK OR ERR |
| | INPUT 5 (COMPUTER-RGB) BLUE (- 30 - + 30) | R C B E | * * * * | OK OR ERR |
| | INPUT 5 (COMPUTER-RGB) CLR TEMP (- 3 - + 3) | R C C T | - - - * | OK OR ERR |

| | CONTROL CONTENTS | COMMAND | PARAMETER | RETURN |
|--|---|---------|-----------|-----------------|
| PICTURE | INPUT 5 (COMPUTER-RGB) DISPLAY | R C R E | - - - 0 | OK OR ERR |
| | INPUT 5 (COMPUTER-RGB) ADJUSTMENT RESET | R C R E | - - - 1 | OK OR ERR |
| | INPUT 1 (COMPONENT 1) SIGNAL TYPE : RGB | I A S I | - - - 1 | OK OR ERR |
| | INPUT 1 (COMPONENT 1) SIGNAL TYPE : COMPONENT | I A S I | - - - 2 | OK OR ERR |
| | INPUT 2 (COMPONENT 2) SIGNAL TYPE : RGB | I B S I | - - - 1 | OK OR ERR |
| | INPUT 2 (COMPONENT 2) SIGNAL TYPE : COMPONENT | I B S I | - - - 2 | OK OR ERR |
| | INPUT 1 (COMPONENT 1) 2D PROGRESSIVE | R A I P | - - - 0 | OK OR ERR |
| | INPUT 1 (COMPONENT 1) 3D PROGRESSIVE | R A I P | - - - 1 | OK OR ERR |
| | INPUT 1 (COMPONENT 1) Film MODE | R A I P | - - - 2 | OK OR ERR |
| | INPUT 2 (COMPONENT 2) 2D PROGRESSIVE | R B I P | - - - 0 | OK OR ERR |
| | INPUT 2 (COMPONENT 2) 3D PROGRESSIVE | R B I P | - - - 1 | OK OR ERR |
| | INPUT 2 (COMPONENT 2) Film MODE | R B I P | - - - 2 | OK OR ERR |
| | INPUT 3 (S-VIDEO) CONTRAST (- 30 - + 30) | V B P I | * * * * | OK OR ERR |
| | INPUT 3 (S-VIDEO) BRIGHTNESS (- 30 - + 30) | V B B R | * * * * | OK OR ERR |
| | INPUT 3 (S-VIDEO) RED (- 30 - + 30) | V B R D | * * * * | OK OR ERR |
| | INPUT 3 (S-VIDEO) BLUE (- 30 - + 30) | V B B E | * * * * | OK OR ERR |
| | INPUT 3 (S-VIDEO) COLOR (- 30 - + 30) | V B C O | * * * * | OK OR ERR |
| | INPUT 3 (S-VIDEO) TINT (- 30 - + 30) | V B T I | * * * * | OK OR ERR |
| | INPUT 3 (S-VIDEO) SHARP (- 30 - + 30) | V B S H | * * * * | OK OR ERR |
| | INPUT 3 (S-VIDEO) CLR TEMP (- 3 - + 3) | V B C T | - - - * | OK OR ERR |
| INPUT 3 (S-VIDEO) DISPLAY | V B R E | - - - 0 | OK OR ERR | |
| INPUT 3 (S-VIDEO) ADJUSTMENT RESET | V B R E | - - - 1 | OK OR ERR | |
| INPUT 4 (VIDEO) CONTRAST (- 30 - + 30) | V A P I | * * * * | OK OR ERR | |
| INPUT 4 (VIDEO) BRIGHTNESS (- 30 - + 30) | V A B R | * * * * | OK OR ERR | |
| INPUT 4 (VIDEO) RED (- 30 - + 30) | V A R D | * * * * | OK OR ERR | |
| INPUT 4 (VIDEO) BLUE (- 30 - + 30) | V A B E | * * * * | OK OR ERR | |
| INPUT 4 (VIDEO) COLOR (- 30 - + 30) | V A C O | * * * * | OK OR ERR | |
| INPUT 4 (VIDEO) TINT (- 30 - + 30) | V A T I | * * * * | OK OR ERR | |
| INPUT 4 (VIDEO) SHARP (- 30 - + 30) | V A S H | * * * * | OK OR ERR | |
| INPUT 4 (VIDEO) CLR TEMP (- 3 - + 3) | V A C T | - - - * | OK OR ERR | |
| INPUT 4 (VIDEO) DISPLAY | V A R E | - - - 0 | OK OR ERR | |
| INPUT 4 (VIDEO) ADJUSTMENT RESET | V A R E | - - - 1 | OK OR ERR | |
| INPUT 3 (S-VIDEO) 2D PROGRESSIVE | V B I P | - - - 0 | OK OR ERR | |
| INPUT 3 (S-VIDEO) 3D PROGRESSIVE | V B I P | - - - 1 | OK OR ERR | |
| INPUT 3 (S-VIDEO) Film MODE | V B I P | - - - 2 | OK OR ERR | |
| INPUT 4 (VIDEO) 2D PROGRESSIVE | V A I P | - - - 0 | OK OR ERR | |
| INPUT 4 (VIDEO) 3D PROGRESSIVE | V A I P | - - - 1 | OK OR ERR | |
| INPUT 4 (VIDEO) Film MODE | V A I P | - - - 2 | OK OR ERR | |
| FINE SYNC ** | CLOCK (- 150 - + 150) | I N C L | * * * * | OK OR ERR |
| | PHASE (- 60 - + 60) | I N P H | * * * * | OK OR ERR |
| | H-POSITION (- 150 - + 150) | I A H P | * * * * | OK OR ERR |
| | V-POSITION (- 60 - + 60) | I A V P | * * * * | OK OR ERR |
| | RGB INPUT DISPLAY | I A R E | - - - 0 | OK OR ERR |
| | RGB ADJUSTMENT RESET | I A R E | - - - 1 | OK OR ERR |
| | SAVE SETTING (1 - 7) | M E M S | - - - * | OK OR ERR |
| | SELECT SETTING (1 - 7) | M E M L | - - - * | OK OR ERR |
| | RGB HORIZONTAL FREQUENCY CHECK | T F R Q | - - - 1 | kHz (***, *OR_) |
| | RGB VERTICAL FREQUENCY CHECK | T F R Q | - - - 2 | Hz (***, *OR_) |
| NORMAL AUTO SYNC | A A D J | - - - 1 | OK OR ERR | |
| HIGH SPEED AUTO SYNC | A A D J | - - - 2 | OK OR ERR | |
| AUTO SYNC OFF | A A D J | - - - 0 | OK OR ERR | |
| AUTO SYNC DISPLAY ON | I M A S | - - - 1 | OK OR ERR | |
| AUTO SYNC DISPLAY OFF | I M A S | - - - 0 | OK OR ERR | |



(RS-232C) Specifications and Command Settings

| | CONTROL CONTENTS | COMMAND | PARAMETER | RETURN |
|-----------------|-----------------------------------|---------|------------------|-----------|
| OPTIONS | THEATER MODE NORMAL | T H M D | _ _ _ 1 | OK OR ERR |
| | THEATER MODE BRIGHT | T H M D | _ _ _ 0 | OK OR ERR |
| | VIDEO 3D DNR OFF | 3 D N R | _ _ _ 0 | OK OR ERR |
| | VIDEO 3D DNR ON | 3 D N R | _ _ _ 1 | OK OR ERR |
| | OSD DISPLAY ON | I M D I | _ _ _ 1 | OK OR ERR |
| | OSD DISPLAY OFF (LEVEL A) | I M D I | _ _ _ 2 | OK OR ERR |
| | OSD DISPLAY OFF (LEVEL B) | I M D I | _ _ _ 0 | OK OR ERR |
| | VIDEO SYSTEM SELECTION : AUTO | M E S Y | _ _ _ 1 | OK OR ERR |
| | VIDEO SYSTEM SELECTION : PAL | M E S Y | _ _ _ 2 | OK OR ERR |
| | VIDEO SYSTEM SELECTION : SECAM | M E S Y | _ _ _ 3 | OK OR ERR |
| | VIDEO SYSTEM SELECTION : NTSC4.43 | M E S Y | _ _ _ 4 | OK OR ERR |
| | VIDEO SYSTEM SELECTION : NTSC3.58 | M E S Y | _ _ _ 5 | OK OR ERR |
| | VIDEO SYSTEM SELECTION : PAL_M | M E S Y | _ _ _ 6 | OK OR ERR |
| | VIDEO SYSTEM SELECTION : PAL_N | M E S Y | _ _ _ 7 | OK OR ERR |
| | BACKGROUND SELECTION : BLUE | I M B G | _ _ _ 1 | OK OR ERR |
| | BACKGROUND SELECTION : NONE | I M B G | _ _ _ 2 | OK OR ERR |
| | AUTO POWER OFF : NO USE | A P O W | _ _ _ 0 | OK OR ERR |
| | AUTO POWER OFF : USE | A P O W | _ _ _ 1 | OK OR ERR |
| LAMP USAGE TIME | T L T T | _ _ _ 1 | 0-9999 (INTEGER) | |
| PRJ MODE | REVERSE OFF | I M R E | _ _ _ 0 | OK OR ERR |
| | REVERSE ON | I M R E | _ _ _ 1 | OK OR ERR |
| | INVERT OFF | I M I N | _ _ _ 0 | OK OR ERR |
| | INVERT ON | I M I N | _ _ _ 1 | OK OR ERR |

| | CONTROL CONTENTS | COMMAND | PARAMETER | RETURN |
|--------------------------|---------------------------------|----------|-----------|-----------|
| LANGUAGE | LANGUAGE SELECTION : ENGLISH | M E L A | _ _ _ 1 | OK OR ERR |
| | LANGUAGE SELECTION : DEUTSCH | M E L A | _ _ _ 2 | OK OR ERR |
| | LANGUAGE SELECTION : ESPAÑOL | M E L A | _ _ _ 3 | OK OR ERR |
| | LANGUAGE SELECTION : NEDERLANDS | M E L A | _ _ _ 4 | OK OR ERR |
| | LANGUAGE SELECTION : FRANÇAIS | M E L A | _ _ _ 5 | OK OR ERR |
| | LANGUAGE SELECTION : ITALIANO | M E L A | _ _ _ 6 | OK OR ERR |
| | LANGUAGE SELECTION : SVENSKA | M E L A | _ _ _ 7 | OK OR ERR |
| | LANGUAGE SELECTION : 日本語 | M E L A | _ _ _ 8 | OK OR ERR |
| | LANGUAGE SELECTION : PORTUGUÊS | M E L A | _ _ _ 9 | OK OR ERR |
| | LANGUAGE SELECTION : 汉语 | M E L A | _ _ _ 10 | OK OR ERR |
| LANGUAGE SELECTION : 한국어 | M E L A | _ _ _ 11 | OK OR ERR | |

NOTE

- If an underbar (_) appears in the parameter column, enter a space. If an asterisk (*) appears, enter a value in the range indicated in brackets under CONTROL CONTENTS.
- *1 FINE SYNC can only be set in the displayed RGB mode.





Wired Remote Control Terminal Specifications

Specifications of wired remote control input

- ø3.5 mm minijack
- External: GND
- Internal: +3.3V

Function and transmission codes

| CONTROL ITEM | SYSTEM CODE | | | | | DATA CODE | | | | | | | | JUDGEMENT CODE | |
|--------------|-------------|----|----|----|----|-----------|----|----|----|-----|-----|-----|-----|----------------|-----|
| | C1 | C2 | C3 | C4 | C5 | C6 | C7 | C8 | C9 | C10 | C11 | C12 | C13 | C14 | C15 |
| ON | 1 | 0 | 1 | 1 | 0 | 0 | 1 | 1 | 0 | 1 | 0 | 1 | 0 | 1 | 0 |
| OFF | 1 | 0 | 1 | 1 | 0 | 0 | 1 | 1 | 0 | 1 | 0 | 0 | 1 | 1 | 0 |
| MENU | 1 | 0 | 1 | 1 | 0 | 0 | 0 | 1 | 0 | 0 | 0 | 1 | 1 | 1 | 0 |
| ▲ | 1 | 0 | 1 | 1 | 0 | 0 | 0 | 1 | 1 | 1 | 0 | 0 | 1 | 1 | 0 |
| ▼ | 1 | 0 | 1 | 1 | 0 | 1 | 0 | 1 | 1 | 1 | 0 | 0 | 1 | 1 | 0 |
| ◀ | 1 | 0 | 1 | 1 | 0 | 0 | 0 | 0 | 0 | 1 | 0 | 1 | 0 | 1 | 0 |
| ▶ | 1 | 0 | 1 | 1 | 0 | 1 | 1 | 1 | 1 | 0 | 0 | 1 | 0 | 1 | 0 |
| ENTER | 1 | 0 | 1 | 1 | 0 | 1 | 1 | 1 | 0 | 1 | 0 | 1 | 0 | 1 | 0 |
| UNDO | 1 | 0 | 1 | 1 | 0 | 1 | 0 | 0 | 1 | 1 | 0 | 1 | 0 | 1 | 0 |
| THEATER MODE | 1 | 0 | 1 | 1 | 0 | 1 | 0 | 0 | 1 | 1 | 0 | 0 | 0 | 1 | 0 |

| CONTROL ITEM | SYSTEM CODE | | | | | DATA CODE | | | | | | | | JUDGEMENT CODE | |
|--------------|-------------|----|----|----|----|-----------|----|----|----|-----|-----|-----|-----|----------------|-----|
| | C1 | C2 | C3 | C4 | C5 | C6 | C7 | C8 | C9 | C10 | C11 | C12 | C13 | C14 | C15 |
| RESIZE | 1 | 0 | 1 | 1 | 0 | 0 | 1 | 1 | 1 | 1 | 0 | 1 | 0 | 1 | 0 |
| GAMMA | 1 | 0 | 1 | 1 | 0 | 0 | 0 | 0 | 0 | 0 | 0 | 1 | 0 | 1 | 0 |
| CLR TEMP + | 1 | 0 | 1 | 1 | 0 | 1 | 0 | 1 | 1 | 1 | 1 | 0 | 0 | 1 | 0 |
| CLR TEMP - | 1 | 0 | 1 | 1 | 0 | 1 | 0 | 0 | 1 | 1 | 1 | 1 | 1 | 1 | 0 |
| AUTO SYNC | 1 | 0 | 1 | 1 | 0 | 0 | 1 | 0 | 1 | 1 | 1 | 1 | 1 | 1 | 0 |
| KEystone | 1 | 0 | 1 | 1 | 0 | 1 | 1 | 1 | 1 | 1 | 1 | 0 | 1 | 1 | 0 |
| INPUT 1 | 1 | 0 | 1 | 1 | 0 | 0 | 1 | 0 | 1 | 1 | 0 | 0 | 0 | 1 | 0 |
| INPUT 2 | 1 | 0 | 1 | 1 | 0 | 0 | 1 | 0 | 1 | 1 | 1 | 0 | 0 | 1 | 0 |
| INPUT 3 | 1 | 0 | 1 | 1 | 0 | 1 | 1 | 1 | 0 | 1 | 1 | 0 | 0 | 1 | 0 |
| INPUT 4 | 1 | 0 | 1 | 1 | 0 | 0 | 1 | 0 | 0 | 1 | 1 | 0 | 0 | 1 | 0 |
| INPUT 5 | 1 | 0 | 1 | 1 | 0 | 1 | 0 | 1 | 0 | 1 | 1 | 0 | 0 | 1 | 0 |

Wired remote control function code

LSB

MSB

| C1 | C2 | C3 | C4 | C5 | C6 | C7 | C8 | C9 | C10 | C11 | C12 | C13 | C14 | C15 |
|----|----|----|----|----|----|----|----|----|-----|-----|-----|-----|-----|-----|
| 1 | 0 | 1 | 1 | 0 | * | * | * | * | * | * | * | * | 1 | 0 |

- System codes C1 to C5 are fixed at "10110".
- Codes C14 and C15 are reverse confirmation bits, with "10" indicating "Front" and "01" indicating "Rear".

Sharp remote control signal format

Transmission format: 15-bit format

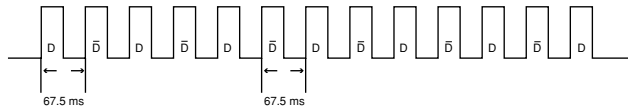

Wave form of output signal: Output using Pulse Position Modulation

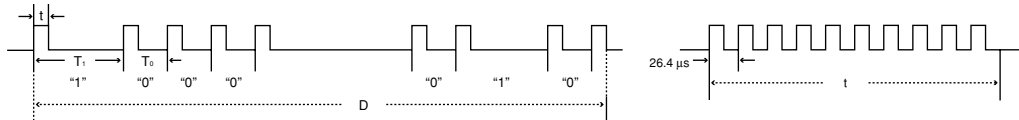

- $t = 264 \mu s$
- $T_0 = 1.05 ms$
- $T_1 = 2.10 ms$
- Pulse carrier frequency = 37.91 kHz
- Duty ratio = 1:1

Transmission control code

15 bit

| C1 | C2 | C3 | C4 | C5 | C6 | C7 | C8 | C9 | C10 | C11 | C12 | C13 | C14 | C15 |
|--------------------------------|----|----|----|----|-----------------------|----|----|----|-----|----------------|-----|------|--------------------|-----|
| System Address | | | | | Function Key Data Bit | | | | | Data Expansion | | Mask | Data Determination | |
| D to \bar{D} Common Data Bit | | | | | Reverse in \bar{D} | | | | | | | | | |

Example of Reverse D to \bar{D}

| D | C1 | C2 | C3 | C4 | C5 | C6 | C7 | C8 | C9 | C10 | C11 | C12 | C13 | C14 | C15 |
|-----------|----|----|----|----|----|----|----|----|----|-----|-----|-----|-----|-----|-----|
| | 1 | 0 | 1 | 1 | 0 | 1 | 0 | 0 | 0 | 0 | 0 | 0 | 0 | 1 | 0 |
| \bar{D} | C1 | C2 | C3 | C4 | C5 | C6 | C7 | C8 | C9 | C10 | C11 | C12 | C13 | C14 | C15 |
| | 1 | 0 | 1 | 1 | 0 | 0 | 1 | 1 | 1 | 1 | 1 | 1 | 1 | 0 | 1 |



Computer Compatibility Chart

Horizontal Frequency: 15–81 kHz

Vertical Frequency: 43–100 Hz

Pixel Clock: 12–120 MHz

Compatible with sync on green and composite sync signals

SXGA compatible in advanced intelligent compression or intelligent compression

AICS (Advanced Intelligent Compression and Expansion System) resizing technology

| PC/MAC/WS | Resolution | Horizontal Frequency (kHz) | Vertical Frequency (Hz) | VESA Standard | Display | |
|-----------|-------------|----------------------------|-------------------------|---------------|---------|--|
| PC | 640 × 350 | 27.0 | 60 | | Upscale | |
| | | 31.5 | 70 | | | |
| | | 37.9 | 85 | × | | |
| | | 720 × 350 | 27.0 | 60 | | |
| | | | 31.5 | 70 | | |
| | | 640 × 400 | 27.0 | 60 | | |
| | 31.5 | | 70 | | | |
| | 37.9 | | 85 | × | | |
| | 720 × 400 | 27.0 | 60 | | | |
| | | 31.5 | 70 | | | |
| | | 37.9 | 85 | × | | |
| | 640 × 480 | 26.2 | 50 | | | |
| | | 31.5 | 60 | × | | |
| | | 34.7 | 70 | | | |
| | | 37.9 | 72 | × | | |
| | | 37.5 | 75 | × | | |
| | | 43.3 | 85 | × | | |
| | | 47.9 | 90 | | | |
| | | 53.0 | 100 | | | |
| | 800 × 600 | 31.4 | 50 | | | |
| | | 35.1 | 56 | × | | |
| | | 37.9 | 60 | × | | |
| | | 44.5 | 70 | | | |
| | | 48.1 | 72 | × | | |
| | | 46.9 | 75 | × | | |
| | | 53.7 | 85 | × | | |
| | | 56.8 | 90 | | | |
| | 64.0 | 100 | | | | |
| | 1,024 × 768 | 35.5 | 43 | × | | |
| | | 40.3 | 50 | | | |
| 56.5 | | 70 | × | | | |
| 58.1 | | 72 | | | | |
| 68.7 | | 85 | × | | | |
| 73.5 | | 90 | | | | |
| 77.2 | | 96 | | | | |
| 80.6 | | 100 | | | | |

| PC/MAC/WS | Resolution | Horizontal Frequency (kHz) | Vertical Frequency (Hz) | VESA Standard | Display | | | |
|-----------|-------------|----------------------------|-------------------------|---------------|----------------------------------|------|----|---------|
| PC | 1,152 × 864 | 54.3 | 60 | | Advanced Intelligent Compression | | | |
| | | 64.0 | 70 | | | | | |
| | | 64.1 | 72 | | | | | |
| | | 67.5 | 75 | × | | | | |
| | | 75.7 | 80 | | | | | |
| | | 54.8 | 60 | | | | | |
| | 1,152 × 882 | 65.9 | 72 | | | | | |
| | | 67.4 | 74 | | | | | |
| | | 64.0 | 60 | × | | | | |
| | | PC/MAC 13* | VGA | 640 × 480 | | 34.9 | 67 | Upscale |
| | | PC/MAC 19* | XGA | 1,024 × 768 | | 48.4 | 60 | × |
| | | | | | | 60.0 | 75 | × |
| MAC 16* | SVGA | 832 × 624 | 46.8 | 75 | | | | |
| | | | 49.6 | 75 | | | | |
| MAC 21* | SXGA | 1,152 × 870 | 68.5 | 75 | | | | |
| PC (WS) | | 1,280 × 960 | 60.0 | 60 | × | | | |
| SGI (WS) | | 1,280 × 1,024 | 53.5 | 50 | | | | |
| SUN (WS) | SXGA | 1,152 × 900 | 60.9 | 66 | | | | |
| | | | 71.9 | 76 | | | | |

NOTE

- This projector may not be able to display images from notebook computers in simultaneous (CRT/LCD) mode. Should this occur, turn off the LCD display on the notebook computer and output the display data in "CRT only" mode. Details on how to change display modes can be found in your notebook computer's operation manual.
- This projector can receive 640 × 350 VESA format VGA signals, however, "640 × 400" will appear on the screen.





Dimensions

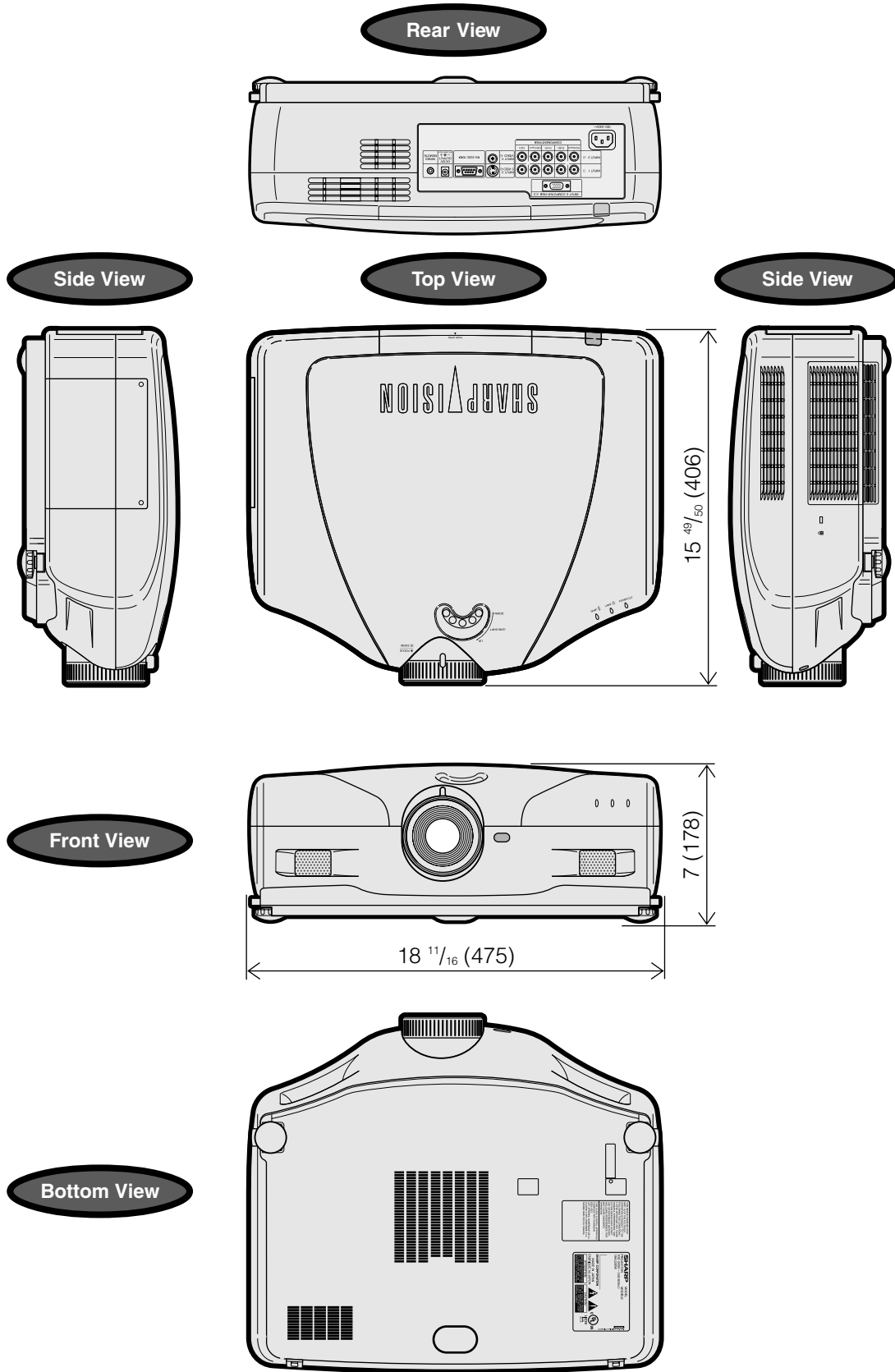

Units: inches (mm)



Specifications

| | |
|-------------------------|---|
| Product type | Projector |
| Model | XV-Z9000U |
| Video system | PAL/PAL 60/PAL-M/PAL-N/SECAM/NTSC 3.58/NTSC 4.43 DTV 480i/480P/720P/1080i |
| Display method | DLP chip, RGB optical shutter method |
| DLP panel | Panel size: 0.8" Display method: Single Panel Digital Micromirror Device (DMD™) by Texas Instruments Drive method: Digital Light Processing (DLP™) No. of dots: 921,600 dots (1,280 [H] × 720 [V]) |
| Lens | 1–1.35 × zoom lens, F3.0, f=32.5–44.0 mm |
| Projection lamp | 275 W NSH lamp |
| Contrast ratio | 1100:1 |
| Video input signal | RCA Connector: VIDEO (INPUT 4), composite video, 1.0 Vp-p, sync negative, 75 Ω terminated |
| S-video input signal | 4-pin Mini DIN connector (INPUT 3) Y (luminance signal): 1.0 Vp-p, sync negative, 75 Ω terminated C (chrominance signal): Burst 0.286 Vp-p, 75 Ω terminated |
| Component input signal | RCA Connector (INPUT 1, 2) Y: 1.0 Vp-p, sync negative, 75 Ω terminated Pb: 0.7 Vp-p, 75 Ω terminated Pr: 0.7 Vp-p, 75 Ω terminated |
| Horizontal resolution | 520 TV lines (NTSC 3.58 input), 750 TV lines (DTV 720P input) |
| RGB input signal | 15-PIN MINI D-SUB CONNECTOR (INPUT 5): RGB separate/composite sync/sync on green type analog input: 0–0.7 Vp-p, positive, 75 Ω terminated HORIZONTAL SYNC. SIGNAL: TTL level (positive/negative) or composite sync (Apple only) VERTICAL SYNC. SIGNAL: Same as above |
| Pixel clock | 12–120 MHz |
| Vertical frequency | 43–100 Hz |
| Horizontal frequency | 15–81 kHz |
| Computer control signal | 9-pin D-sub connector (RS-232C Port) |
| Rated voltage | AC 100–240 V |
| Input current | 3.8 A |
| Rated frequency | 50/60 Hz |
| Power consumption | 365 W (SELECTING “BRIGHT” in the “Theater Mode”) 310 W (SELECTING “NORMAL” in the “Theater Mode”) |
| Power dissipation | 1,400 BTU/hour |
| Operating temperature | 41°F to 95°F (+5°C to +35°C) |
| Storage temperature | –4°F to 140°F (–20°C to +60°C) |
| Cabinet | Plastic |
| I/R carrier frequency | 38 kHz |
| Dimensions (approx.) | 18 ¹ / ₁₆ " (W) × 7" (H) × 15 ⁴⁹ / ₆₀ " (D) (475 × 178 × 406 mm) (main body only) 18 ¹ / ₁₆ " (W) × 7" (H) × 19 ¹ / ₂ " (D) (475 × 178 × 496 mm) (including terminal cover) |
| Weight (approx.) | 20.9 lbs. (9.5 kg) (main body only) |
| Supplied accessories | Remote control, Two AA size batteries, Power cord (11' 10", 3.6 m), Terminal cover, Lens cap (attached), CD-ROM, Projector operation manual, SharpVision Manager operation manual |
| Replacement parts | Lamp unit (Lamp/cage module) (BQC-XVZ9000/1), Remote control (RRMCG1657CESA), AA size batteries, Power cord (CACCU5013DE01), Terminal cover (CCOVA1985CE01), Lens cap (PCAPH1056CESA), CD-ROM (UDSKA0047CEN1), Projector operation manual (TINS-7416CEZZ), SharpVision Manager operation manual (TINS-7418CEZZ) |

This SHARP projector uses a DMD chip. This very sophisticated chip contains 921,600 pixels. As with any high technology electronic equipment such as large screen TVs, video systems and video cameras, there are certain acceptable tolerances that the equipment must conform to.

This unit has some inactive pixels within acceptable tolerances which may result in inactive dots on the picture screen. This will not affect the picture quality or the life expectancy of the unit. If you have any questions about this matter, please call toll free 1-877-DTV-SHARP (1-877-388-7427). [U.S.A. ONLY]

Specifications are subject to change without notice.





Glossary

Aspect ratio

Width and height ratio of an image. The normal aspect ratio of a computer and video image is 4 : 3. There are also wide images with an aspect ratio of 16 : 9 and 21 : 9.

Auto Sync

Optimizes projected computer images by automatically adjusting certain characteristics.

Background

Initial setting image projected when no signal is being input.

Cinema zoom

Mode that projects the 16:9 image which uses the center of the image signal on the full-screen.

Clock

Clock adjustment is used to adjust vertical noise when clock level is incorrect.

CLR Temp (Color temperature)

Function that can be used to adjust the color temperature to suit the type of image input to the projector. Decrease the color temperature to create warmer, reddish images for natural flesh tones, or increase to create cooler, bluish images for a brighter picture.

Composite sync

Signal combining horizontal and vertical sync pulses.

Digital keystone correction

Function to digitally correct a distorted image when the projector is set up at an angle, smoothes out jaggies on keystone images and compresses the image not only horizontally but vertically keeping the 4 : 3 aspect ratio.

Digital shift

Shifts image up or down easily by ▲/▼ buttons when RESIZE mode of input image is SMART STRETCH, CINEMA ZOOM, or DOT BY DOT of COMPUTER, VIDEO and DTV inputs.

Dot by dot

Mode that projects images in their native resolution.

GAMMA

Image quality enhancement function that offers a richer image by brightening the darker portions of the image without altering the brightness of the brighter portions. You can select four different modes : STANDARD, GAMMA 1, GAMMA 2 and CUSTOM.

Intelligent compression and expansion

High quality resizing of lower and higher resolution images to fit the projector's native resolution.

Lens shift

The lens can be easily raised and lowered to minimize or eliminate "Keystone" type effect.

Phase

Phase shift is a timing shift between isomorphic signals with the same resolution. When phase level is incorrect, the projected image typically displays horizontal flicker.

Progressive Mode

The progressive display projects a smoother video image. You can select three different modes : 2D Progressive, 3D Progressive and Film Mode.

RESIZE

Allows you to modify or customize the picture display mode to enhance the input image. You can select six different modes: SIDE BAR, SMART STRETCH, CINEMA ZOOM, STRETCH, NORMAL, and DOT BY DOT.

RS-232C

Function to control the projector from the computer by using the RS-232C ports on the projector and computer.

Side bar

Mode that projects the normal 4:3 image at the 4:3 area for the center of the screen.

Smart Stretch

Mode that stretches the right and left sides of the 4:3 image horizontally while maintaining the aspect ratio around the center of the image to display it on the WIDE screen.

Status function

Displays the settings of each adjustment item.

Stretch

Mode that stretches the 4:3 image horizontally to display it on the WIDE screen.

Sync on green

Video signal mode of a computer which overlaps horizontal and vertical sync signal to green color signal pin.

3D DNR (3D Digital Noise Reduction)

Provides high quality images with minimal background.





Index

| | | |
|--|----|--|
| A | | |
| AC socket | 13 | |
| ADJUSTMENT buttons | 26 | |
| Adjusting the Picture | 29 | |
| Adjustment feet | 18 | |
| Air filters | 49 | |
| Aspect ratio | 23 | |
| Automatic power shutoff function | 41 | |
| Auto sync adjustment | 35 | |
| AUTO SYNC button | 35 | |
| B | | |
| Background | 39 | |
| BACKLIGHT button | 16 | |
| C | | |
| Ceiling-mount | 22 | |
| Ceiling+Rear | 43 | |
| CINEMA ZOOM | 23 | |
| Clock | 32 | |
| CLR TEMP (Color Temperature) buttons | 30 | |
| COMPONENT/RGB terminals | 14 | |
| COMPUTER-RGB port | 15 | |
| D | | |
| Digital shift | 40 | |
| DOT BY DOT | 23 | |
| E | | |
| Economy Mode | 41 | |
| ENTER button | 9 | |
| Exhaust ventilative hole | 4 | |
| F | | |
| Focus ring | 17 | |
| G | | |
| GAMMA button | 25 | |
| GUI (Graphical User Interface) | 26 | |
| I | | |
| INPUT buttons | 23 | |
| K | | |
| Kensington Lock | 49 | |
| KEYSTONE button | 19 | |
| L | | |
| LAMP REPLACEMENT indicator | 45 | |
| Lens shift | 18 | |
| M | | |
| MENU button | 26 | |
| O | | |
| On-screen display | 37 | |
| On-screen display Language | 43 | |
| P | | |
| Phase | 32 | |
| POWER buttons | 17 | |
| Power cord | 13 | |
| POWER indicator | 45 | |
| Progressive Mode | 31 | |
| R | | |
| Rear projection | 22 | |
| Remote control | 11 | |
| Remote control sensor | 16 | |
| Remote control signal transmitter | 11 | |
| RESIZE button | 23 | |
| RS-232C Off Function | 41 | |
| RS-232C port | 51 | |
| S | | |
| Save Setting | 33 | |
| Select Setting | 33 | |
| SIDE BAR | 23 | |
| SMART STRETCH | 23 | |
| Status function | 44 | |
| STRETCH | 23 | |
| Subtitle | 40 | |
| S-VIDEO INPUT terminal | 13 | |
| SXGA | 24 | |
| Sync | 35 | |
| Sync on green | 51 | |
| T | | |
| TEMPERATURE WARNING indicator | 45 | |
| THEATER MODE button | 38 | |
| Transmission Speed (RS-232C) | 42 | |
| U | | |
| UNDO button | 26 | |
| V | | |
| VIDEO INPUT terminal | 13 | |
| Video System | 37 | |
| W | | |
| Wired remote control input jack | 16 | |
| Z | | |
| Zoom knob | 17 | |
| No. | | |
| 3D DNR (3D Digital Noise Reduction) | 36 | |



Notes
