



# Table of contents

+	+	+	+	Table of Contents .....	1
+	+	+	+	Usage Notice .....	2
				<i>Safety Information</i> .....	2
				<i>Precautions</i> .....	3
				<i>Eye Safety Warnings</i> .....	5
+	+	+	+	Introduction .....	6
				<i>Product Features</i> .....	6
				<i>Package Overview</i> .....	7
				<i>Product Overview</i> .....	8
				<i>Main Unit</i> .....	8
				<i>Control Panel</i> .....	9
				<i>Connection Ports</i> .....	10
				<i>Remote Control</i> .....	11
+	+	+	+	Installation .....	12
				<i>Connecting the Projector</i> .....	12
				<i>Powering On/Off the Projector</i> .....	14
				<i>Powering On the Projector</i> .....	14
				<i>Powering Off the projector</i> .....	15
				<i>Warning Indicator</i> .....	15
				<i>Adjusting the Projected Image</i> .....	16
				<i>Adjusting the Projector's Height</i> .....	16
				<i>Adjusting the Projector's Zoom / Focus</i> .....	17
				<i>Adjusting Projection Image Size</i> .....	17
+	+	+	+	User Controls .....	18
				<i>Control Panel &amp; Remote Control</i> .....	18
				<i>On-screen Display Menus</i> .....	21
				<i>How to operate</i> .....	21
				<i>Menu Tree</i> .....	22
				<i>Image</i> .....	23
				<i>Display</i> .....	27
				<i>Setup</i> .....	32
				<i>Options</i> .....	40
+	+	+	+	Appendices .....	45
				<i>Troubleshooting</i> .....	45
				<i>Image Problems</i> .....	45
				<i>Projector Status Indication</i> .....	48
				<i>Remote Control Problems</i> .....	49
				<i>Replacing the Lamp</i> .....	50
				<i>Compatibility Modes</i> .....	51
				<i>RS232 Commands and Protocol Function List</i> .....	52
				<i>Ceiling Mount Installation</i> .....	56
				<i>Optoma Global Offices</i> .....	57
				<i>Regulation &amp; Safety Notices</i> .....	59

## Safety Information

	The lightning flash with arrow head within an equilateral triangle is intended to alert the user to the presence of uninsulated "dangerous voltage" within the product's enclosure that may be of sufficient magnitude to constitute a risk of electric shock to persons.
	The exclamation point within an equilateral triangle is intended to alert the user to the presence of important operating and maintenance (servicing) instructions in the literature accompanying the appliance.

**WARNING:** TO REDUCE THE RISK OF FIRE OR ELECTRIC SHOCK, DO NOT EXPOSE THIS APPLIANCE TO RAIN OR MOISTURE. DANGEROUS HIGH VOLTAGES ARE PRESENT INSIDE THE ENCLOSURE. DO NOT OPEN THE CABINET. REFER SERVICING TO QUALIFIED PERSONNEL ONLY.

### Class B emissions limits

This Class B digital apparatus meets all requirements of the Canadian Interference-Causing Equipment Regulations.

### Important Safety Instruction

1. Do not block any ventilation openings. To ensure reliable operation of the projector and to protect from over heating, it is recommended to install the projector in a location that does not block ventilation. As an example, do not place the projector on a crowded coffee table, sofa, bed, etc. Do not put the projector in an enclosure such as a book case or a cabinet that restricts air flow.
2. Do not use the projector near water or moisture. To reduce the risk of fire and/or electric shock, do not expose the projector to rain or moisture.
3. Do not install near heat sources such as radiators, heaters, stoves or any other apparatus such as amplifiers that emits heat.
4. Clean only with dry cloth.
5. Only use attachments/accessories specified by the manufacturer.
6. Do not use the unit if it has been physically damaged or abused. Physical damage/abuse would be (but not limited to):
  - Unit has been dropped.
  - Power supply cord or plug has been damaged.
  - Liquid has been spilled on to the projector.
  - Projector has been exposed to rain or moisture.
  - Something has fallen in the projector or something is loose inside.Do not attempt to service the unit yourself. Opening or removing covers may expose you to dangerous voltages or other hazards. Pl. call Optoma before you send the unit for repair.
7. Do not let objects or liquids enter the projector. They may touch dangerous voltage points and short out parts that could result in fire or electric shock.
8. See projector enclosure for safety related markings.
9. The unit should only be repaired by appropriate service personnel.

## Precautions



*Please follow all warnings, precautions and maintenance as recommended in this user's guide.*

- ■ Warning- Do not look into the projector's lens when the lamp is on. The bright light may hurt your eyes.
- ■ Warning- To reduce the risk of fire or electric shock, do not expose this projector to rain or moisture.
- ■ Warning- Please do not open or disassemble the projector as this may cause electric shock.
- ■ Warning- When replacing the lamp, please allow the unit to cool down. Follow instructions as described on page 50.
- ■ Warning- This projector will detect the life of the lamp itself. Please be sure to change the lamp when it shows warning messages.
- ■ Warning- Reset the "Lamp Reset" function from the on-screen display "Options | Lamp Settings" menu after replacing the lamp module (refer to page 43).
- ■ Warning- When switching the projector off, please ensure the cooling cycle has been completed before disconnecting power. Allow 90 seconds for the projector to cool down.
- ■ Warning- Do not use lens cap when projector is in operation.
- ■ Warning- When the lamp is approaching to the end of its life time, the message "Replacement suggested" will show on the screen. Please contact your local reseller or service center to change the lamp as soon as possible.

### Note

When the lamp reaches the end of its life, the projector will not turn back on until the lamp module has been replaced. To replace the lamp, follow the procedures listed under "Replacing the Lamp" section on page 50.

# Usage Notice



## *Do:*

- ■ Turn off and unplug the power plug from the AC outlet before cleaning the product.
- ■ Use a soft cloth moistened with mild detergent to clean the display housing.
- ■ Disconnect the power plug from AC outlet if the product is not being used for a long period of time.



## *Do not:*

- ■ Block the slots and openings on the unit provided for ventilation.
- ■ Use abrasive cleaners, waxes or solvents to clean the unit.
- ■ Use under the following conditions:
  - In extremely hot, cold or humid environments.
    - ▶ Ensure that the ambient room temperature is within 5 - 35°C
    - ▶ Relative Humidity is 5 - 35°C, 80% (Max.), non-condensing
  - In areas susceptible to excessive dust and dirt.
  - Near any appliance generating a strong magnetic field.
  - In direct sunlight.

## Eye Safety Warnings



- ■ Avoid staring/facing directly into the projector beam at all times. Keep your back to the beam as much as possible.
- ■ A stick or laser pointer is recommended to avoid the need for the user to enter the beam.
- ■ When projector is used in a classroom, adequately supervise students when they are asked to point out something on the screen.
- ■ In order to minimize the lamp power, use room blinds to reduce ambient light levels.

# Introduction

## Product Features

*This product is a 1080p single chip 0.95" DLP® projector.*

- ■ Native 16:9 1080p DLP® Technology
- ■ Video Compatibility:
  - 480i-NTSC, NTSC4.43
  - 576i-PAL/PAL-M/PAL-N/SECAM
  - SDTV compatible (480i/p, 576i/p)
  - HDTV compatible (720p, 1080i/p)
  - RGB signal: UXGA+, SWXGA+, SXGA+, SXGA, WXGA, HD, XGA, SVGA and VGA re-sizing
- ■ Macintosh compatible
- ■ Full function IR remote control with laser pointer and mouse control
- ■ Advanced vertical digital keystone correction and high quality full screen image re-scaling
- ■ Audio input x 5 (For DVI-D / VGA1 / VGA2 / S-Video+ Video(RCA) / HDMI)
- ■ Built-in two speakers with 2 Watt amplifier
- ■ User friendly control panel and multilingual on screen menu
- ■ HDMI & DVI support HDCP function
- ■ Support Network function



# Introduction

## Package Overview

Unpack and inspect the box contents to ensure all parts listed below are in the box. If something is missing, please contact Optoma customer service.

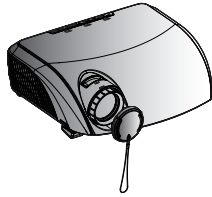

Projector with lens cap

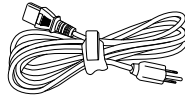

Power Cord 1.8m

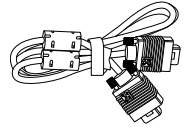

VGA Cable 1.8m

### Note

Due to different applications in each Country, some regions may have different accessories.

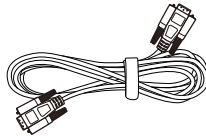

RS232 Cable 1.8m

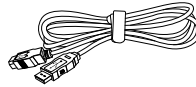

USB Cable 1.8m



Remote Controller



2 x AA Batteries

### Documentation :

- User's Manual
- Warranty Card
- Quick Start Card
- WEEE Card

# Introduction

## Product Overview

### Main Unit

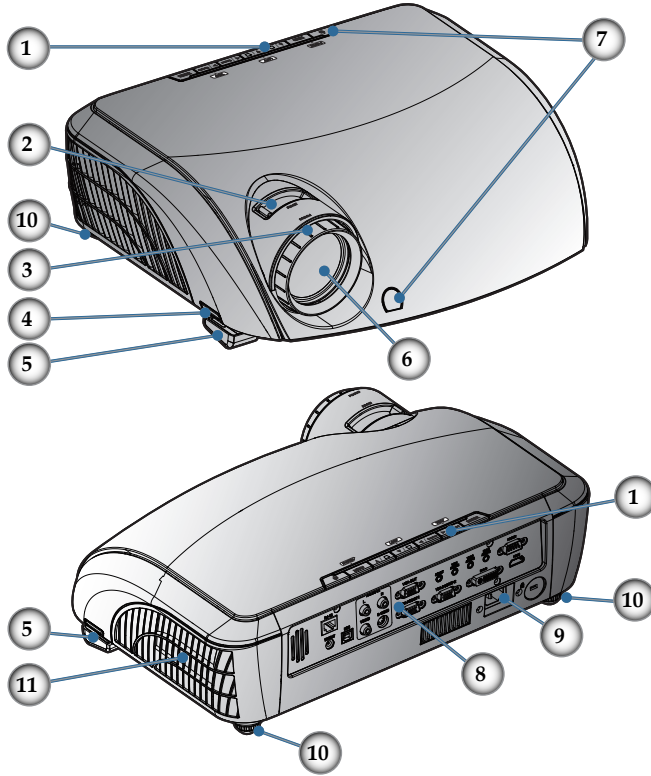

1. Control Panel
2. Zoom Lever
3. Focus Ring
4. Elevator Button (one on each side)
5. Elevator Feet
6. Zoom Lens
7. IR Receivers
8. Connection Ports
9. Power Socket
10. Tilt-Adjustment Feet
11. Air exhaust vent



# Introduction

## Control Panel

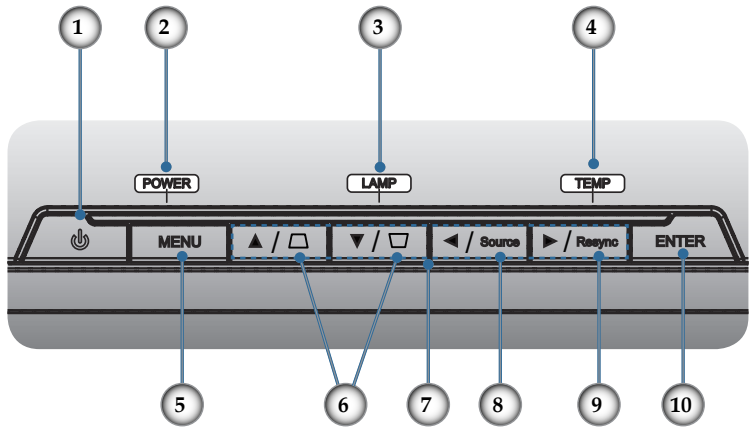

1. Power and IR Receiver
2. Power Indicator LED
3. Lamp Indicator LED
4. Temp Indicator LED
5. Menu (On/Off)
6. Keystone
7. Four Directional Select Keys
8. Source Select
9. Re-Sync
10. Enter

# Introduction

## Connection Ports

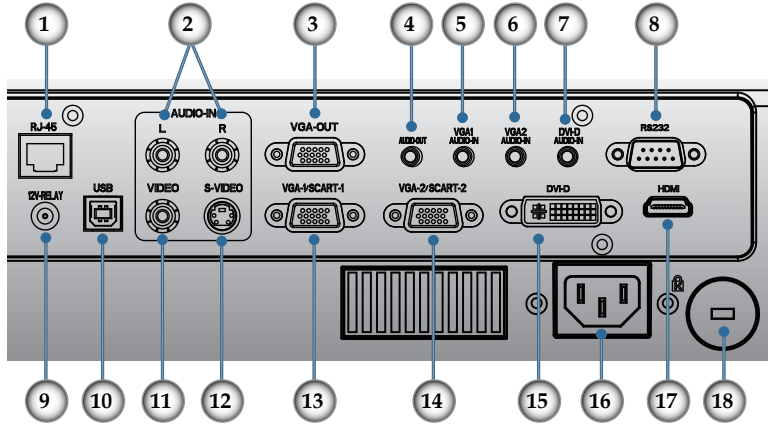

1. RJ45
2. RCA Audio In (L/R)
3. VGA Out
4. Audio Out
5. Audio In (For VGA1)
6. Audio In (For VGA2)
7. Audio In (For DVI-D)
8. RS232
9. 12V Relay
10. USB Port
11. Composite Video
12. S-Video
13. VGA-1/SCART-1/HDTV/Component Video Input Connector
14. VGA-2/SCART-2/HDTV/Component Video Input Connector
15. DVI-D
16. Power Socket
17. HDMI
18. Kensington Lock

# Introduction

## Remote Control

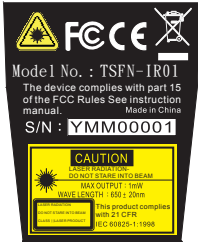

1. Laser Button
2. AV Mute
3. Power (On/Off)
4. Re-Sync
5. Keystone
6. Page Up
7. Page Down
8. PC/Mouse Control
9. Mouse Right Click
10. Enter
11. Four Directional Select Keys
12. Display Format
13. Source
14. VGA1
15. VGA2
16. Freeze
17. Display Mode
18. Zoom In
19. Zoom Out
20. Volume +/-
21. Mouse Left Click
22. Menu
23. Source Lock
24. Picture-In-Picture
25. DVI
26. HDMI
27. Swap
28. S-Video
29. Video

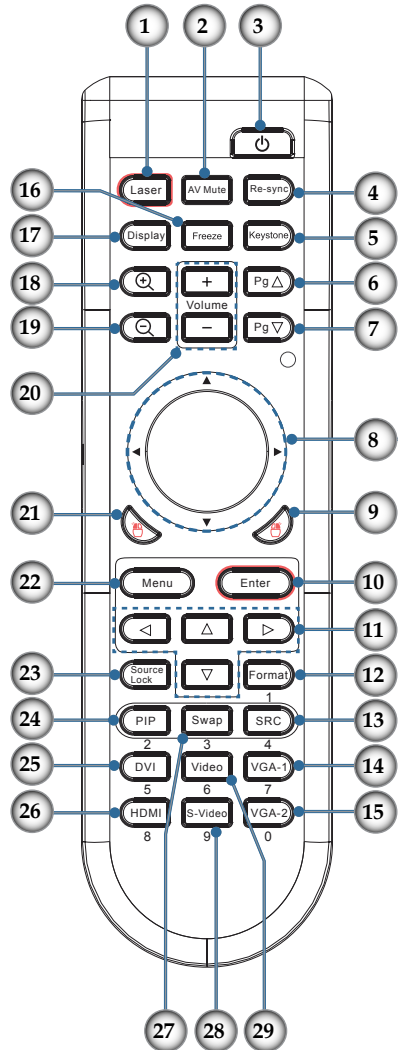

## Connecting the Projector

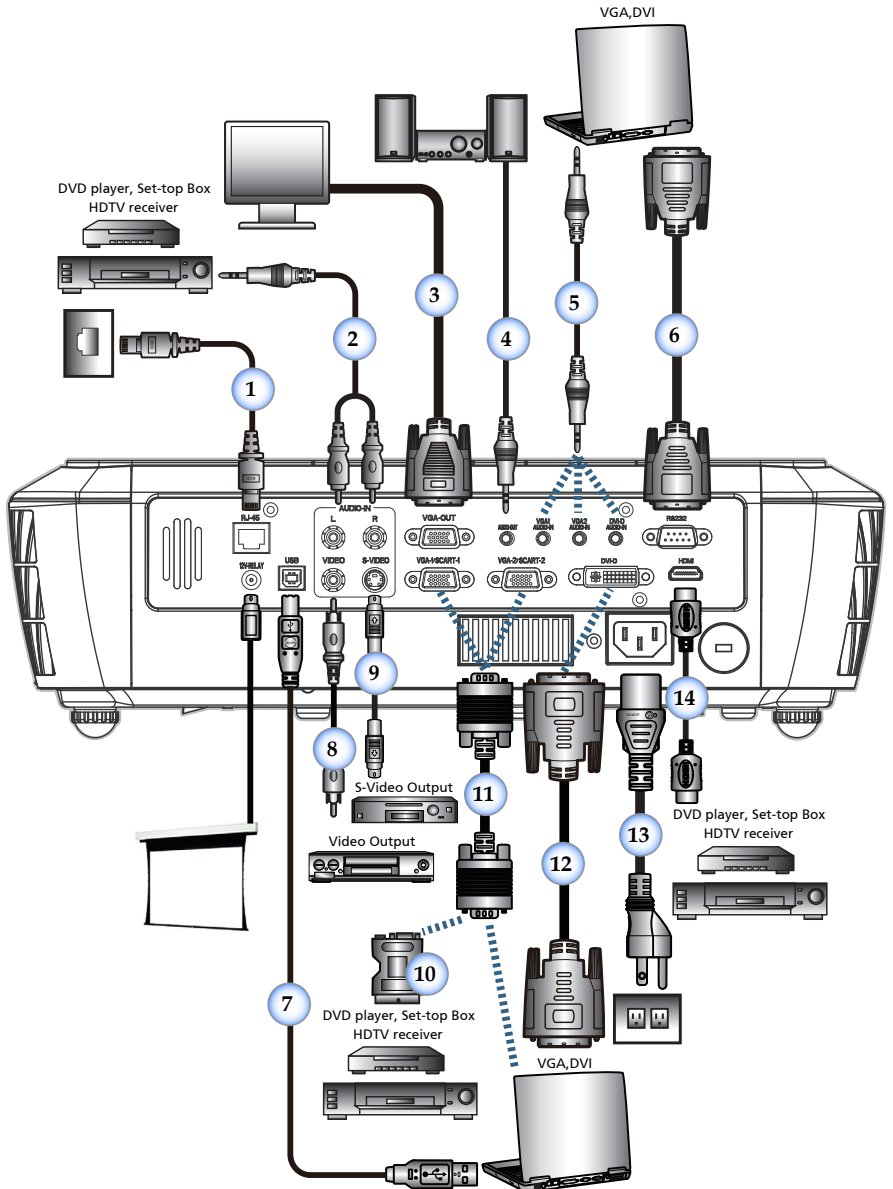

# Installation

## Note

Due to the difference in applications for each country, some regions may have different accessories.

- 1.....Network Cable (Optional Accessory)
- 2..... Audio L/R Input Cable (Optional Accessory)
- 3.....VGA Output Cable (Optional Accessory)
- 4..... Audio Output Cable (Optional Accessory)
- 5.....Audio Input Cable (Optional Accessory)
- 6..... RS232 Cable
- 7..... USB Cable
- 8..... Composite Video Cable (Optional Accessory)
- 9.....S-Video Cable (Optional Accessory)
- 10..... SCART RGB/S-Video Adapter (Optional Accessory)
- 11..... VGA Input Cable
- 12..... DVI Cable (Optional Accessory)
- 13.....Power Cord
- 14..... HDMI Cable (Optional Accessory)

## Powering On/Off the Projector

### Powering On the Projector

1. Remove the lens cap. ❶
  2. Securely connect the power cord and signal cable. When connected, the power led will turn red.
  3. Turn on the lamp by pressing “⏻” button on the control panel. The power led will now flash blue. ❷  
The startup screen will display in approximately 30 seconds. The first time you use the projector, you can select your preferred language from quick menu after the startup screen display.
  4. Turn on your source that you want to display on the screen (computer, notebook, video player, etc). The projector will detect the source automatically and will display on the screen. If not, push menu button and go to “Options”. Make sure that the “Source Lock” has been set to “Off”.
- If you connected multiple sources at the same time, press the “Source” button on the control panel or direct source key on the remote control to switch between inputs.

#### Note

Turn on the projector first and then select the signal sources.

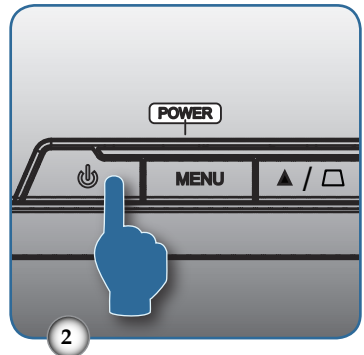
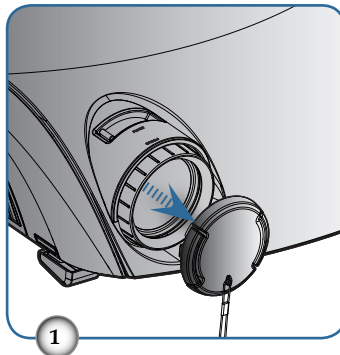

## Powering Off the Projector

1. Press the “⏻” button to turn off the projector. The following message will be displayed on the screen.

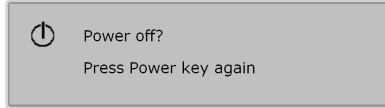

Press the “⏻” button again to confirm the shut down. If the button is not pressed, the message will disappear in 5 seconds.

2. The cooling fans continue to operate for about 60 seconds for cooling cycle and the Power LED will flash blue. When the lights solid red, the projector has entered standby mode.  
If you wish to turn the projector back on, you must wait until the projector has completed the cooling cycle and has entered standby mode. Once in standby mode, simply press “⏻” button to restart the projector.
3. Disconnect the power cord from the electrical outlet and the projector.
4. Do not turn on the projector immediately following a power off procedure.

## Warning Indicator

- When the “LAMP” indicator led is lit red, the projector will automatically shut down. Please call the nearest Optoma facility for assistance.
- When the “TEMP” indicator flashes red, it indicates the projector has overheated. The projector will shut down automatically.  
Under normal conditions, the projector can be switched on again after it has cooled down.
- When the “LAMP” indicator flashes red, it indicates the fan has failed.

### Note

Contact the nearest service center if the projector displays these symptoms. See page 55 for more information.

## Adjusting the Projected Image

### Adjusting the Projector's Height

The projector is equipped with elevator feet for adjusting the image height.

To raise the image:

1. Press the elevator button **1**.
2. Raise the image to the desired height angle **2**, then release the button to lock the elevator feet into position.
3. Use screw in feet **3** to fine-tune the display angle.

To lower the image:

1. Press the elevator button.
2. Lower the image, then release the button to lock the elevator feet into position.
3. Use screw in feet **3** to fine-tune the display angle.

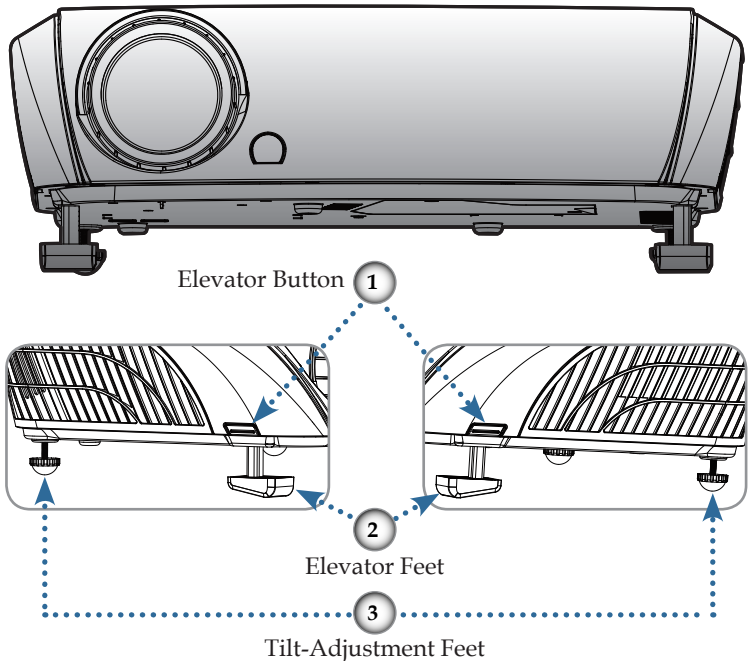



## Adjusting the Projector's Zoom / Focus

Turn the Zoom Lever to zoom in or zoom out. To focus the image, turn the focus ring until you see a clear image. The projector will focus at distances from 4.9 to 41.0 feet (1.5 to 12.5 meters) and the projection screen size from 0.68m~7.75m (26.77"~305.22") at 16:9 mode with mechanical travel.

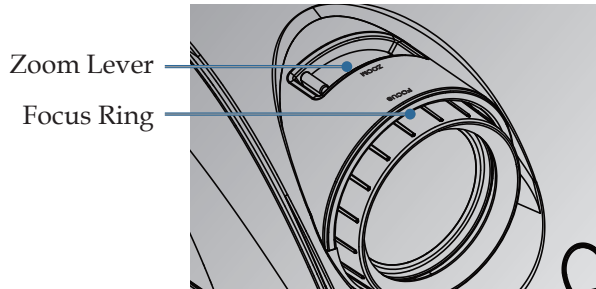

## Adjusting Projection Image Size

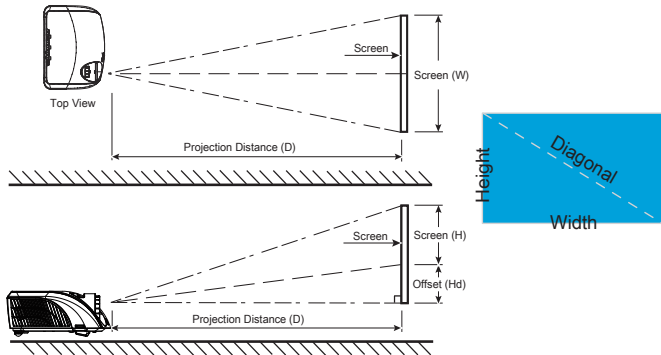

Diagonal length (inch) size of 16:9 Screen	Screen Size W X H (16:9)				Projection distance (D)				Offset (Hd)	
	(m)		(feet)		(m)		(feet)		(m)	(feet)
	wide	tele	wide	tele	wide	tele	wide	tele		
27	0.60	0.34	1.97	1.11	1.11	1.33	3.64	4.37	0.12	0.40
37	0.81	0.46	2.66	1.50	1.50	1.80	4.92	5.91	0.16	0.54
50	1.11	0.62	3.64	2.04	2.05	2.46	6.73	8.07	0.22	0.74
60	1.34	0.75	4.38	2.46	2.47	2.96	8.10	9.72	0.27	0.89
70	1.55	0.87	5.09	2.86	2.87	3.44	9.42	11.30	0.31	1.03
80	1.78	1.00	5.85	3.29	3.28	3.94	10.76	12.91	0.36	1.18
90	1.99	1.12	6.53	3.68	3.69	4.43	12.11	14.53	0.40	1.33
100	2.22	1.25	7.27	4.09	4.10	4.92	13.45	16.14	0.45	1.47
120	2.66	1.50	8.72	4.91	4.92	5.90	16.14	19.37	0.54	1.77
150	3.32	1.87	10.90	6.14	6.15	7.38	20.18	24.21	0.67	2.21
200	4.32	2.49	14.17	8.18	8.20	9.84	26.90	32.28	0.90	2.94
300	6.65	3.74	21.81	12.27	12.30	14.76	40.35	48.43	1.35	4.42

❖ This graph is for user's reference only.

# User Controls

## Control Panel & Remote Control

There are two ways for you to control the functions: Control Panel and Remote Control.

---

### Using the Control Panel

---

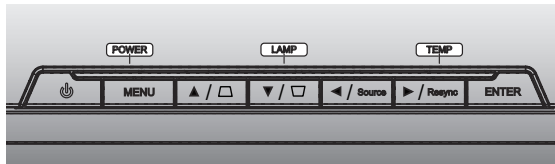

---

<b>Power</b>	Refer to the “Power On/Off the Projector” section on pages 14-15.
--------------	---

---

<b>Source</b>	Press “Source” to select the input signal source.
---------------	---

---

<b>Menu</b>	Press “Menu” to launch the on-screen display (OSD) menu. To exit OSD, Press “Menu” again.
-------------	---

---

<b>Keystone</b>	Adjust image distortion caused by tilting the projector.
-----------------	--

---

<b>Four Directional Select Keys</b>	Use ▲ ▼ ◀ ▶ to select items or make adjustments to your selection.
-------------------------------------	--

---

<b>Enter</b>	Confirm your item selection.
--------------	------------------------------

---

<b>Re-Sync</b>	Automatically synchronize the projector to the input source.
----------------	--

---

# User Controls

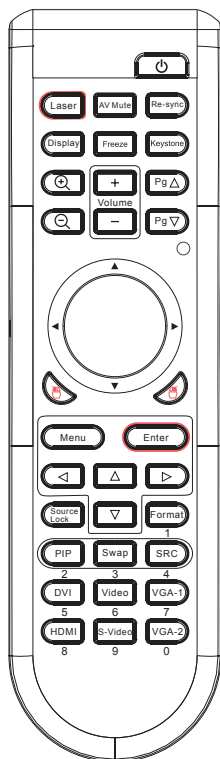

## Using the Remote Control

<b>Power</b>	Refer to the “Power On/Off the Projector” section on pages 14-15.
<b>Laser</b>	Aim the remote at the viewing screen, press and hold this button to activate the laser pointer.
<b>AV Mute</b>	Momentarily turn on/off the audio and video.
<b>Re-sync</b>	Automatically synchronize the projector to the input source.
<b>Display</b>	Select the display mode from Presentation, Bright, Movie, sRGB, User1 and User2.
<b>Freeze</b>	Press “Freeze” to pause the screen image. Press this button again to unlock.
<b>Keystone</b>	Adjust image distortion caused by tilting the projector.
<b>Zoom In</b>	Zoom in to magnify the image.
<b>Zoom Out</b>	Zoom out to reduce the image.
<b>Volume +/-</b>	Adjust to increase/decrease the volume.
<b>Pg Δ Page Up</b>	Use this button to page up.
<b>Pg ∇ Page Down</b>	Use this button to page down.
<b>Mouse Control</b>	The PC/Mouse control can be used to control mouse movement. The mouse function is enabled using the USB cable to connect your computer and the projector.
<b>L Button</b>	Mouse left click.
<b>R Button</b>	Mouse right click.
<b>Menu</b>	Display or exit the on-screen display menus for projector.
<b>Enter</b>	Confirm your item selection.
<b>Four Directional Select Keys</b>	Use $\Delta$ $\nabla$ $\triangleleft$ $\triangleright$ to select items or make adjustments to your selection.

# User Controls

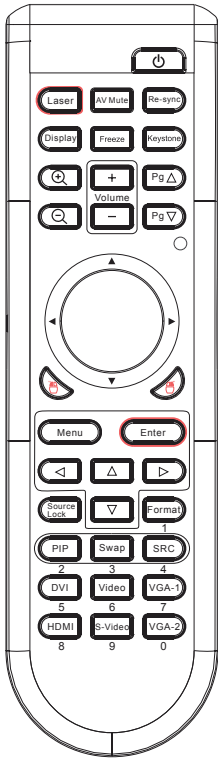

<b>Source Lock</b>	Select auto detection all connector ports or lock current connector port.
<b>Format</b>	Display the "Aspect Ratio" section of the on-screen display menu to select the desired aspect ratio.
<b>PIP</b>	Press "PIP" to open the PIP window. Main screen is large; PIP screen is small and displays in the corner of the main screen.
<b>Swap</b>	Press "Swap" to swap the main screen and PIP screen.
<b>SRC</b>	Select the input signal source at the next terminal.
<b>DVI</b>	Press "DVI" to choose digital signal source from DVI connector.
<b>Video</b>	Press "Video" to choose Composite video source.
<b>VGA-1</b>	Press "VGA1" to choose source from VGA1-In/SCART connector.
<b>VGA-2</b>	Press "VGA2" to choose source from VGA2-In/SCART connector.
<b>S-Video</b>	Press "S-Video" to choose S-video source.
<b>HDMI</b>	Press "HDMI" to choose HDMI1 source.

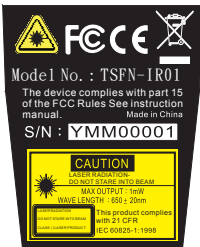

## On-screen Display Menus

The Projector has multilingual On-screen Display menus that allow you to make image adjustments and change a variety of settings. The projector will automatically detect the source.

### How to operate

1. To open the OSD menu, press “Menu” on the Remote Control or Control Panel.
2. When OSD is displayed, use ▲ ▼ keys to select any item in the main menu. While making a selection on a particular page, press ► or “Enter” key to enter sub menu.
3. Use ▲ ▼ keys to select the desired item and adjust the settings by ◀▶ key.
4. Select the next item to be adjusted in the sub menu and adjust as described above.
5. Press “Enter” or “Menu” to confirm, and the screen will return to the main menu.
6. To exit, press “Menu” again. The OSD menu will close and the projector will automatically save the new settings.

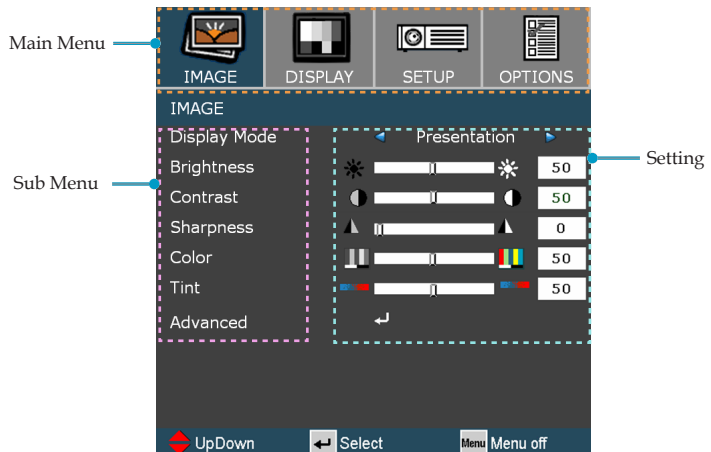

# User Controls

## Menu Tree

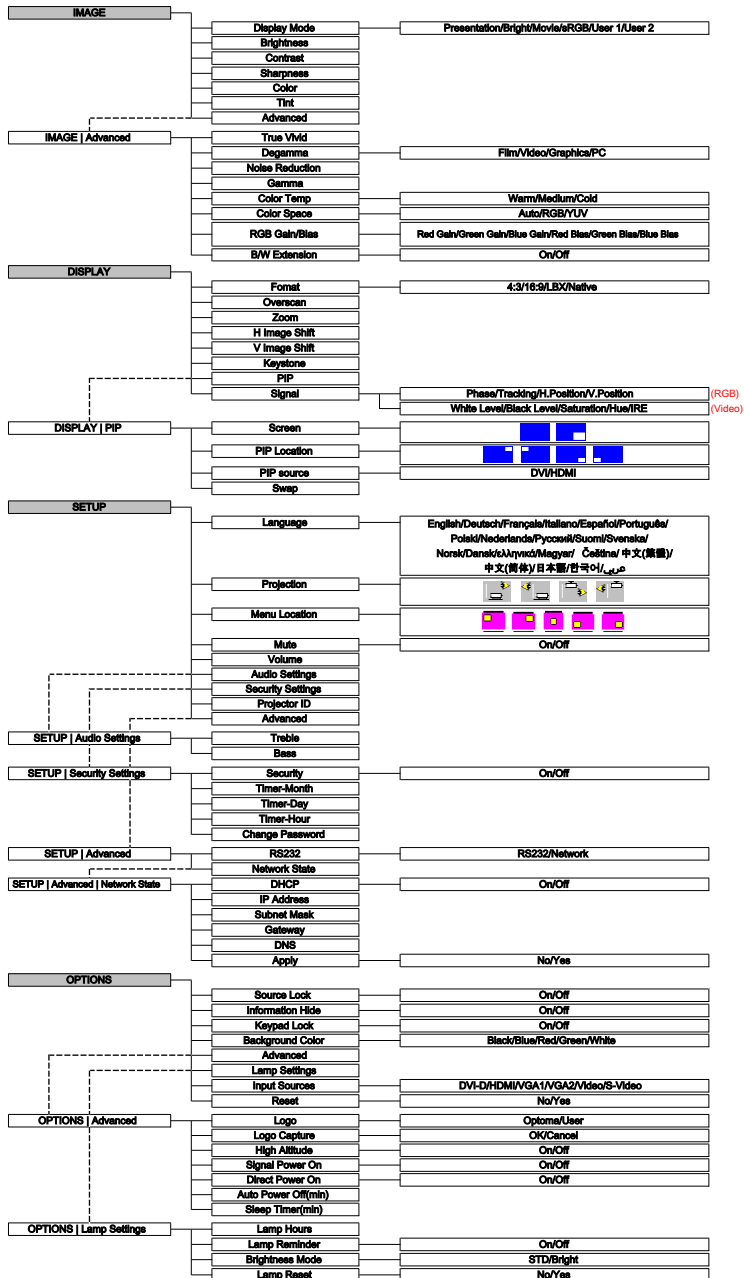

## Image

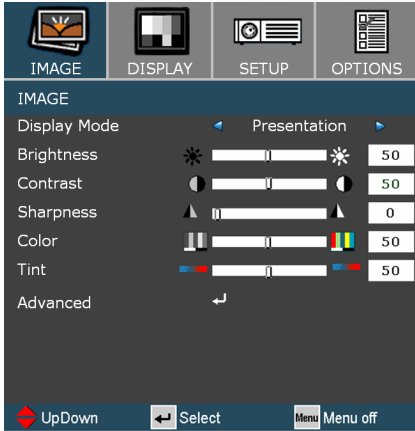

### Display Mode

There are many factory presets optimized for various types of images.

- ▶ Presentation: Good color and brightness from PC input.
- ▶ Bright: Maximum brightness from PC input.
- ▶ Movie: For home theater.
- ▶ sRGB: Standardize accurate color.
- ▶ User1: User's settings.
- ▶ User2: User's settings.

### Brightness

Adjust the brightness of the image.

- ▶ Press the ◀ to darken image.
- ▶ Press the ▶ to lighten the image.

### Contrast

The contrast controls the degree of difference between the lightest and darkest parts of the picture. Adjusting the contrast changes the amount of black and white in the image.

- ▶ Press the ◀ to decrease the contrast.
- ▶ Press the ▶ to increase the contrast.

### Sharpness

Adjust the sharpness of the image.

- ▶ Press the ◀ to decrease the sharpness.
- ▶ Press the ▶ to increase the sharpness.

# User Controls

## Color

Adjust a video image from black and white to fully saturated color.

- ▶ Press the ◀ to decrease the amount of color in the image.
- ▶ Press the ▶ to increase the amount of color in the image.

## Tint

Adjust the color balance of red and green.

- ▶ Press the ◀ to increase the amount of green in the image.
- ▶ Press the ▶ to increase the amount of red in the image.



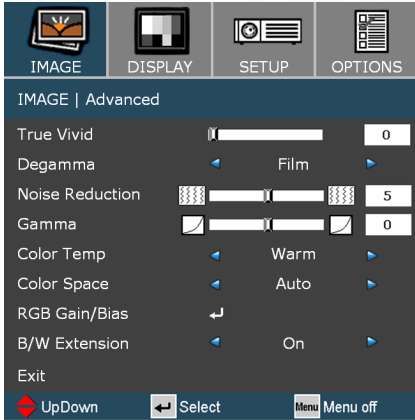

## Image | Advanced

### True Vivid

This adjustable item utilizes a new color-processing algorithm and enhancements to enable the picture's vividness to be significantly increased.

### Degamma

This allows you to choose a degamma table that has been fine-tuned to bring out the best image quality for the input.

- ▶ Film: For home theater.
- ▶ Video: For video or TV source.
- ▶ Graphics: For image source.
- ▶ PC: For PC or computer source.

### Noise Reduction

The motion Adaptive Noise Reduction reduces the amount of visible noise interlaced signals. The range is from "0" to "10". (0:Off)

### Gamma

This unit comes with 10 preset gamma curves. After the initial setup and fine tuning is completed, utilize the Gamma Adjustment steps to optimize your image output.

### Color Temp

If set to cold temperature, the image looks bluish (cold image). If set to warm temperature, the image tends to look reddish (warm image).

# User Controls

## Color Space

Select an appropriate color matrix type from RGB or YPbPr.

## RGB Gain/Bias

Press **↩** into the next menu as below and then use **▲** or **▼** to select item. Use **◀** or **▶** to select Red, Green, or Blue for brightness (Gain) and contrast (Bias).

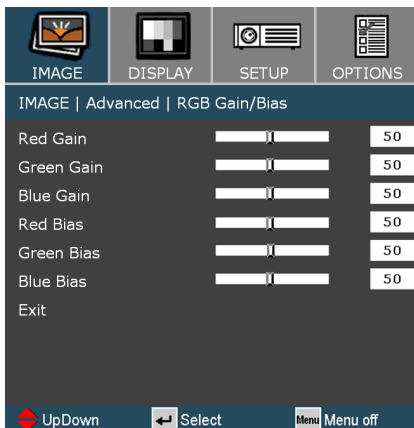

## B/W Extension

Black and White Extension can stretch the black and white levels to automatically increase the contrast of input image. This unit has 2 pre-set modes that allow the user to switch among the pre-sets to obtain different image effects. (Off/On)

# User Controls

## Display

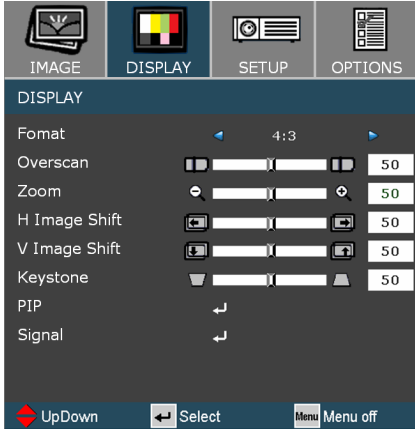

### Format

Use this function to choose your desired aspect ratio.

- ▶ 4:3: This format is for 4x3 input sources.
- ▶ 16:9: This format is for 16x9 input sources, like HDTV and DVD enhanced for Widescreen TV.
- ▶ Native: This format displays the original image without any scaling.

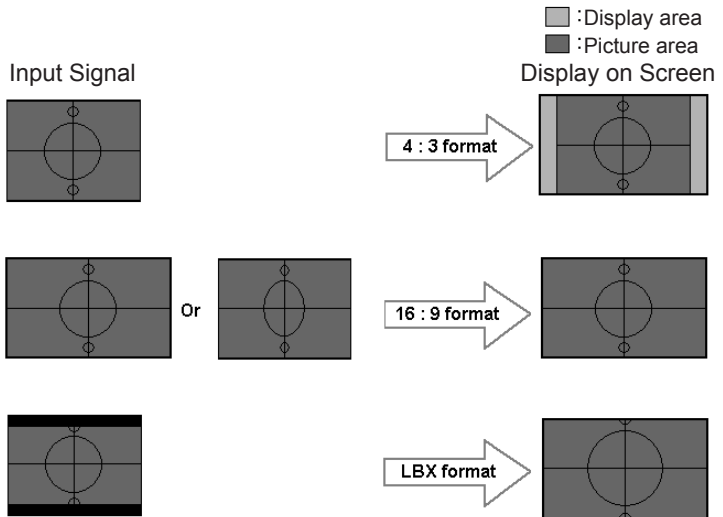

# User Controls

- ▶ **LBX:** This format is for non-16x9, letterbox source and for users who use external 16x9 lens to display 2.35:1 aspect ratio using full resolution.

Detail informations about LBX mode :

1. Some Letter-Box DVDs are not enhanced for 16x9 TVs. In this situation, the image will not look right when displayed in 16:9 mode.

In this situation, please try to using the 4:3 mode to view the DVD.

If the content is not 4:3, there will be black bars around the image in 16:9 display. For this type of content, you can use LBX mode to fill the image on the 16:9 display.

2. If you use an external 16x9 lens, this LBX mode also allows you to watch a 2.35:1 content (include Anamorphic DVD and HDTV film source) that support anamorphic wide is enhanced for 16x9 Display in a wide 2.35:1 image.

In this case, there are no black bars. Lamp power and vertical resolution are fully utilized.

## Overscan

Overscan function removes the noise in a video image. Overscan the image to remove video encoding noise on the edge of video source.



(\*) Each I/O has different setting of "Overscan".

(\*) "H Image shift" is only supported on 4:3 and Native formats. If source is 1080i/p, "H image shift" is only supported in 4:3.

## Zoom

- ▶ Press the ◀ to reduce the size of an image.
- ▶ Press the ▶ to magnify an image on the projection screen.

## H Image Shift

Shift the projected image position horizontally.

## V Image Shift

Shift the projected image position vertically.

## Keystone

Press the ◀ or ▶ to adjust image distortion vertically and make a squarer image.

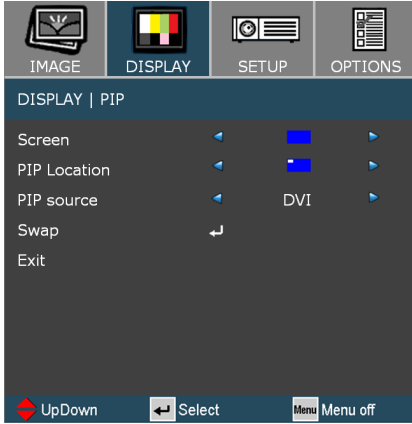

## Display | PIP

### Screen

- ▶ Single : Projection single screen.
- ▶ PIP Window : Main Screen is large screen; PIP Screen is small and displays in the corner of the main screen.



To use PIP function, one source must be connected to the DVI (Digital) input.

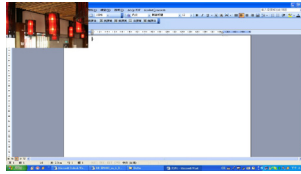

PIP Window

### PIP Location

Choose the PIP screen position on the display screen.

### PIP Source

Choose the PIP source to switch PIP screen source.

### Swap

Press "Enter" to swap main screen and PIP screen.

# User Controls

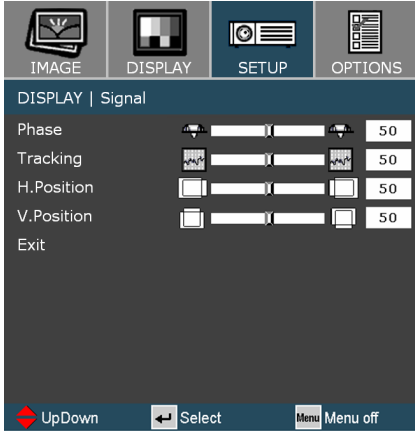

## Display | Signal (RGB)



Signal is not supported on HDMI or DVI-D signals.

### Phase

Change the display data frequency to match the frequency of your computer's graphic card. Use this function only if the image appears to flicker vertically.

### Tracking

Synchronize the signal timing of the display with the graphics card. If the image appears to be unstable or flickers, use this function to correct it.

### H Position

Adjust the horizontal position.

### V Position

Adjust the vertical position.

# User Controls

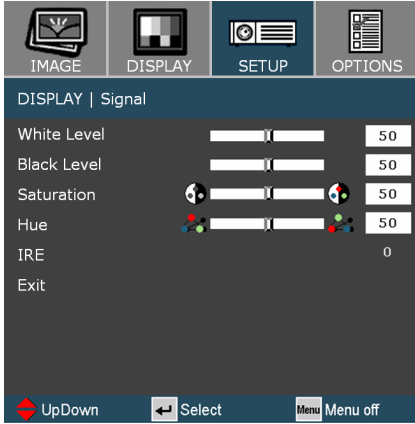

## Display | Signal (Video)

### White Level

Allow user to adjust White Level when input signals are S-video or Composite video/CVBS signals.

### Black Level

Allow user adjust Black Level when inputting S-Video or Video/CVBS signals.

### Saturation

Adjust a video image from black and white to fully saturated color. Press the ◀ to decrease the amount of color in the image. Press the ▶ to increase the amount of color in the image.

### Hue

Adjust the color balance of red and green. Press the ◀ to increase the amount of green in the image. Press the ▶ to increase the amount of red in the image.



“IRE” is only supported on IRE NTSC signal.

Adjust measurement of composite video signals.

# User Controls



## Setup

### Language

Choose the multilingual OSD menu. Press ◀ or ▶ into the sub menu and then use the ▲ or ▼ key to select your preferred language. Press “Select (Enter)” to finalize the selection.

### Projection

- ▶  Front-Projection

This is the default selection. The image is projected straight on the screen.

- ▶  Rear-Desktop

When selected, the image will appear reversed.

- ▶  Front-Ceiling

When selected, the image will turn upside down.

- ▶  Rear-Ceiling

When selected, the image will appear reversed in upside down position.

### Menu Location

Choose the menu location on the display screen.

### Mute

#### Note

Rear-Desktop and Rear-Ceiling are to be used with a translucent screen.



# User Controls

- ▶ Choose “On” to turn mute on.
- ▶ Choose “Off” to turn mute off.

## Volume

- ▶ Press the ◀ to decrease the volume.
- ▶ Press the ▶ to increase the volume.

## Audio Settings

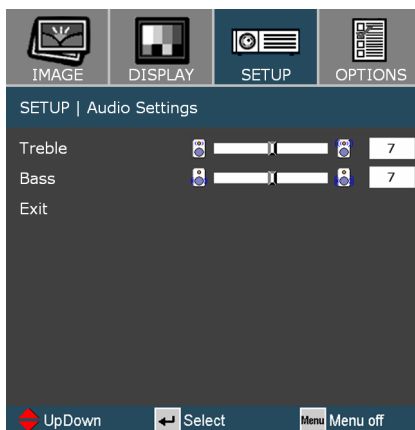

- ▶ Treble:
  - Press the ◀ to decrease the treble volume.
  - Press the ▶ to increase the treble volume.
- ▶ Bass:
  - Press the ◀ to decrease the bass volume.
  - Press the ▶ to increase the bass volume.

# User Controls

## Security Settings

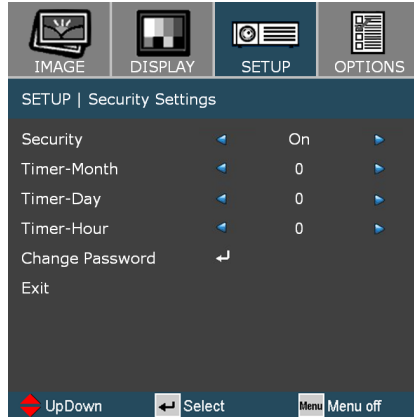

### ▶ Security:

- On: Choose "On" to enable security verification when turning on the projector.
- Off: Choose "Off" to be able to switch on the projector without password verification.

### ▶ Timer - Month/Day/Hour:

This function is used to select the number of hours the projector can be used (month/day/hour). When you have reached the limit, you will be asked to enter the password again.

### ▶ Change Password:

Select subnet mask number.

#### ■ First Time:

1. Press  to set the password.
2. The password has to be 4 digits.
3. Use number buttons on the remote to enter your new password and then press "Enter" key to confirm your password.



Pass-code default value is "0000" (first time).

# User Controls

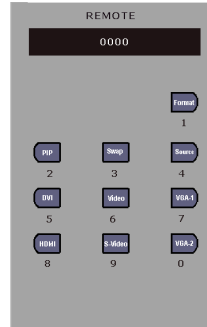

## ■ Change Password:

1. Press “Enter” to input old password.
2. Use number button to enter current password and then press “Enter” to confirm.
3. Enter new password (4 digits in length) using the number buttons on the remote, then press “Enter” to confirm.
4. Enter new password again and press “Enter” to confirm.

## Projector ID

ID definition can be set up by menu (range 01~99), and allow user control an individual projector by RS232. Refer to page 52 for the complete list of RS232 commands.

# User Controls

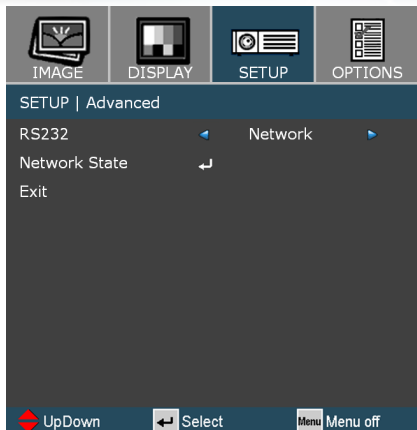

## *Setup | Advanced*

### RS232

- ▶ RS232: Allow RS232 control of an individual projector.
- ▶ Network: Allow network LAN via web browser (Internet Explorer) to control of projector.



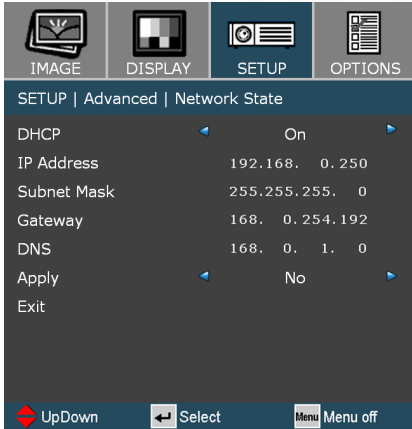

## Setup | Advanced | Network State

### DHCP

- ▶ On: Assign an IP address to the projector from the DHCP server automatically.
- ▶ Off: Assign an IP address manually.

### IP Address

Select an IP address.

### Subnet Mask

Select subnet mask number.

### Gateway

Select the default gateway of the network connected to the projector.

### DNS

Select DNS number.

### Apply

Press "Yes" to apply the selection.

# User Controls

## How to use web browser to control your projector

1. Fill in a new IP, a subnet mask, a gateway and a DNS in the dialog box.

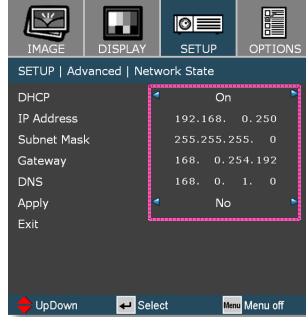

2. Then choose apply and press “↵” button to effectuate the configuration process.
3. Open your web browser and type in from the OSD LAN screen then the web page will display as below:



When you used the projector IP address, you will can not link to your service server..

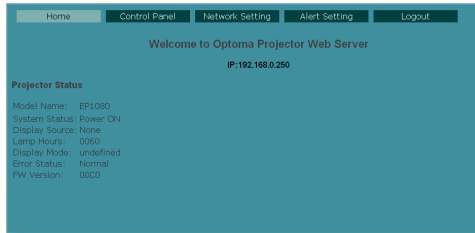

4. Open “Control Panel” to control your projector.

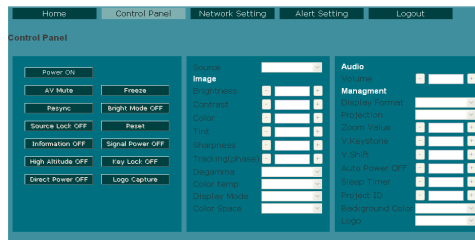

*For example: Use Microsoft Internet Explorer (IE) web browser to control the projector , the IP address is [http:// 192.168.0.100](http://192.168.0.100).*

Step 1: Find an IP Address (192.168.0.250) from LAN function of projector.

IP Address 192.168. 0. 250

# User Controls

Step 2: Select apply and press “Enter” button to submit function or press “menu” key to exit.

Step 3: To open Network Connections, click **Start**, click **Control Panel**, click **Network and Internet Connections**, and then click **Network Connections**. Click the connection you want to configure, and then, under **Network Tasks** , click **Change settings of this connection**.

Step 4: On the **General** tab, under **This connection uses the following items**, click **Internet Protocol (TCP/IP)**, and then click “Properties.”

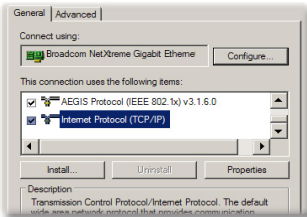

Step 5: Click **Use the following IP address**, and type in as below:

- 1) IP address: 192.168.0.250
- 2) Subnet mask: 255.255.255.0
- 3) Default gateway: 168.0.254.192

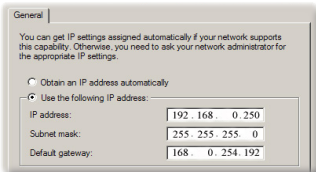

Step 6: To open Internet Options, click **IE web browser**, click **Internet Options**, click the **Connections** tab and click “LAN Settings...”

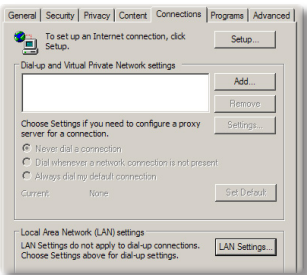

Step 7: The **Local Area Network (LAN) Setting** dialog box appears, In the **Proxy Server** area, cancel the **Use a proxy server for your LAN** check box., then click “OK” button twice.

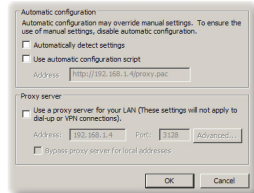

Step 8: Open your IE and type in the IP address of 192.168.0.250 in the URL then press “Enter” key. The web page will display as below:



Step 9: Open “Control Panel” to control your projector.

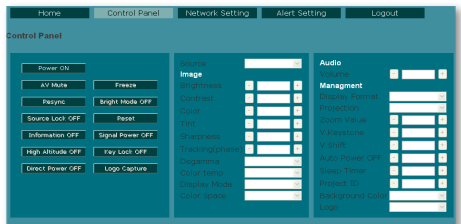

# User Controls

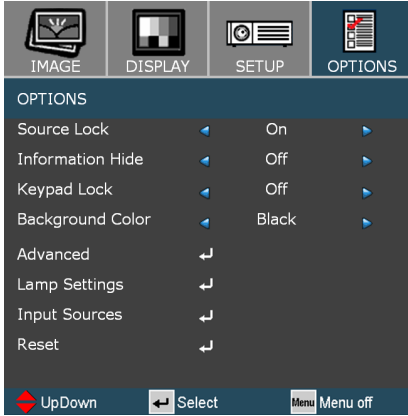

## Options

### Source Lock

- ▶ On: The projector will search specified connection port.
- ▶ Off: The projector will search for other signals if the current input signal is lost.

### Information Hide

- ▶ On: Choose "On" to hide the searching message.
- ▶ Off: Choose "Off" to show the searching message.

### Keypad Lock

When the keypad lock function is at "On", the control panel will be locked however, the projector can be operated by the remote control. By selecting "Off", you will be able to reuse the control panel.

### Background Color

Use this feature to display a "Black", "Blue", "Red", "Green" or "White" screen when no signal is available.



To turn off the keypad lock, press and hold "Enter" key on top of the projector for 7 seconds.



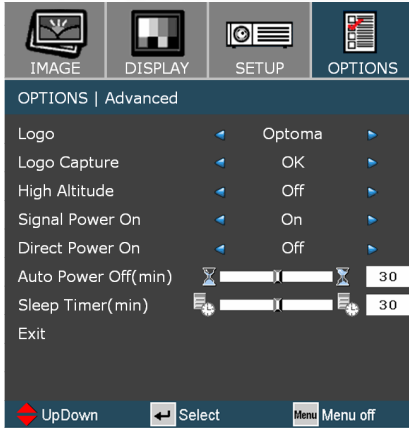

## Options | Advanced

### Logo

Use this function to select the desired startup screen. If changes are made, the new setting will take effect the next time when you open the OSD.

- ▶ Optoma: The default startup screen of Optoma projector.
- ▶ User: Use memorize picture from “Logo Capture” function.

### Logo Capture

Press “OK” to immediately capture a picture what on the display screen.

### High Altitude

When “On” is selected, the fans will spin faster. This feature is useful in high altitude areas where the air is thin.

### Signal Power On

- ▶ On: The projector will automatically power on when plug in any signal source to the projector at standby mode.
- ▶ Off: Turn on the projector to normal mode.

### Direct Power On

When “On” is selected, the projector will automatically turn on when AC power is supplied to the projector.

# User Controls

## Auto Power Off (min)

This timer gets activated when no signal is being sent to the projector. The projector will automatically shut off after the countdown has finished.

## Sleep Timer (min)

When activated, the sleep timer will continue to run regardless of user intervene or signal.

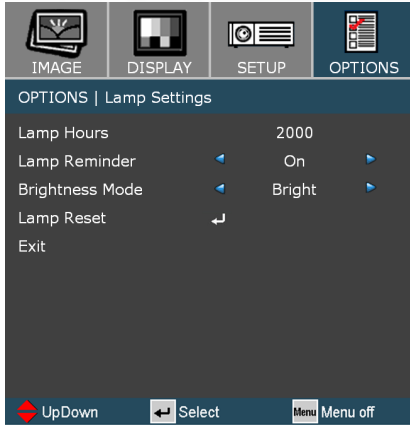

## Options | Lamp Settings

### Lamp Hours

Display total lamp hours.

### Lamp Reminder

When turned on, a message will appear 30 hours before the end of suggested replacement lamp hour.

### Brightness Mode

- ▶ STD: Choose “STD” to dim the projector lamp which will lower power consumption and extend the lamp life by up to 130%.
- ▶ Bright: Choose “Bright” to increase the brightness.

### Lamp Reset

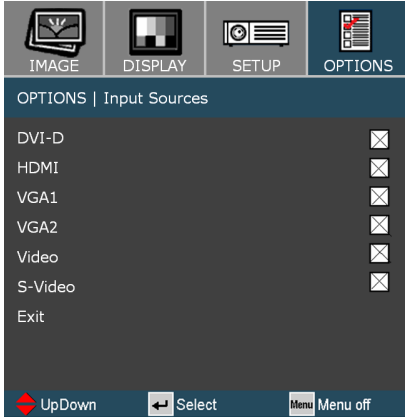

Reset the lamp life hour after replacing the lamp.

# User Controls



## Options | Input Source

### Input Sources

Enable input sources. Press  into the next menu as below and then use  or  to select. Press “Enter” to finalize the selection. The projector will not search inputs that are de-selected.

## Troubleshooting

*If you experience a problem with your projector, please refer to the following information. If a problem persists, please contact your local reseller or service center.*

### Image Problems

#### **?** No image appears on-screen

- ▶ Ensure all the cables and power connections are correctly and securely connected as described in the “Installation” section.
- ▶ Ensure the pins of connectors are not crooked or broken.
- ▶ Check if the projection lamp has been securely installed. Please refer to the “Replacing the lamp” section.
- ▶ Make sure you have removed the lens cap and the projector is switched on.

#### **?** Partial, scrolling or incorrectly displayed image

- ▶ Press “Re-Sync” on the control panel.
- ▶ If you are using a PC:

For Windows 95, 98, 2000, XP:

1. From the “My Computer” icon, open the “Control Panel” folder, and double click the “Display” icon.
2. Select the “Settings” tab.
3. Verify that your display resolution setting is lower than 1920 x 1080.
4. Click on the “Advanced Properties” button.

**If the projector is still not projecting the whole image, you will also need to change the monitor display you are using. Refer to the following steps.**

5. Verify the resolution setting is lower than or equal to 1920 x 1080.

# Appendices

6. Select the “Change” button under the “Monitor” tab.
  7. Click on “Show all devices.” Next, select “Standard monitor types” under the SP box; choose the resolution mode you need under the “Models” box.
  8. Verify that the resolution setting of the monitor display is lower than or equal to 1920 x 1080.
- ▶ If you are using a Notebook:
1. First, follow the steps above to adjust resolution of the computer.
  2. Press the appropriate keys listed below for your notebook manufacturer to send signal out from notebook to projector.  
Example: [Fn]+[F4]

Acer ⇨	[Fn]+[F5]	IBM/Lenovo ⇨	[Fn]+[F7]
Asus ⇨	[Fn]+[F8]	HP/Compaq ⇨	[Fn]+[F4]
Dell ⇨	[Fn]+[F8]	NEC ⇨	[Fn]+[F3]
Gateway ⇨	[Fn]+[F4]	Toshiba ⇨	[Fn]+[F5]

Mac Apple:  
System Preference-->Display-->Arrangement-->Mirror display

- ▶ If you experience difficulty changing resolutions or your monitor freezes, restart all equipment including the projector.

## **? The screen of the Notebook or PowerBook computer is not displaying your presentation**

- ▶ If you are using a Notebook PC:

Some Notebook PCs may deactivate their own screens when a second display device is in use. Each has a different way to be reactivated. Refer to your computer’s manual for detailed information.

## **? Unstable or flickering image**

- ▶ Use “Tracking” to correct it. See page 30 for more information.
- ▶ Change the monitor color setting on your computer.

## **? Image has vertical flickering bar**

- ▶ Use “Phase” to make an adjustment. See page 30 for more information.
- ▶ Check and reconfigure the display mode of your graphic card to make it compatible with the projector.

## **? Image is out of focus**

- ▶ Make sure the Lens cap is removed.
- ▶ Adjust the Focus Ring on the projector lens.
- ▶ Make sure the projection screen is between the required distance 4.9 to 41.0 feet (1.5 to 12.5 meters) from the projector. See page 17.

## **? The image is stretched when displaying 16:9 DVD title**

- ▶ When you play anamorphic DVD or 16:9 DVD, the projector will show the best image in 16: 9 format on projector side.
- ▶ If you play the LBX format DVD title, please change the format as LBX in projector OSD.
- ▶ If you play 4:3 format DVD title, please change the format as 4:3 in projector OSD.
- ▶ If the image is still stretched, you will also need to adjust the aspect ratio by referring to the following:
- ▶ Please setup the display format as 16:9 (wide) aspect ratio type on your DVD player.

## **? Image is too small or too large**

- ▶ Adjust the zoom lever on the top of the projector.
- ▶ Move the projector closer to or further from the screen.
- ▶ Press [Menu] on the projector panel, go to "Display-->Format". Try the different settings.

## **? Image has slanted sides:**

- ▶ If possible, reposition the projector so that it is centered on the screen and below the bottom of the screen.
- ▶ Use "Display-->Keystone" from the OSD to make an adjustment.

## **? Image is reversed**

- ▶ Select "Setup-->Projection" from the OSD and adjust the projection direction.

## **Intermission Problems**

### **? The projector stops responding to all controls**





























- ▶ If possible, turn off the projector, then unplug the power cord and wait at least 20 seconds before reconnecting power.

## **?** Lamp burns out or makes a popping sound

- ▶ When the lamp reaches its end of life, it will burn out and may make a loud popping sound. If this happens, the projector will not turn on until the lamp module has been replaced. To replace the lamp, follow the procedures in the “Replacing the Lamp” section on page 50.

## Projector Status Indication

### **?** LED states

Message	Power LED (Red)	Power LED (Blue)	Temp-LED (Red)	Lamp-LED (Red)
Standby State (Input power cord)				
Power on (Warming)		Flashing		
Power on and Lamp lighting		* 		
Power off (Cooling)		Flashing		
Error (Lamp fail)				
Error (Thermal fail)				
Error (Fan fail)				Flashing
Error (Over Temp.)			Flashing	



\* Power LED be ON when OSD appears, be OFF when OSD disappears.

### **?** Message Reminders

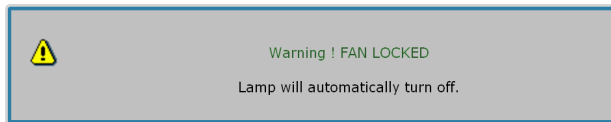
- ▶ Fan failed:



### Note

Steady light =>   
 No light => 



- ▶ Over temperature:



Warning ! TEMPERATURE TOO HIGH

Lamp will automatically turn off.

- ▶ Replacing the lamp:



Replacement Suggested!

Lamp is approaching the end of its useful life

## Remote Control Problems

### **?** If the remote control does not work

- ▶ Check the operating angle for the remote control is approximately  $\pm 22.5^\circ$ .
- ▶ Make sure there are not any obstructions between the remote control and the projector. Move to within 6 m (20 ft) of the projector.
- ▶ Make sure batteries are inserted correctly.
- ▶ Replace batteries if they are exhausted.

## Replacing the lamp

The projector automatically detects the lamp life. When the lamp life is nearing the end of use, you will receive a warning message.

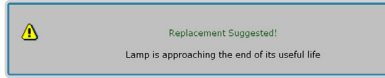

Warning: Lamp compartment is hot! Allow it to cool down before changing lamp!

When you see this message, please contact your local reseller or service center to change the lamp as soon as possible. Make sure the projector has been cooled down for at least 30 minutes before changing the lamp.

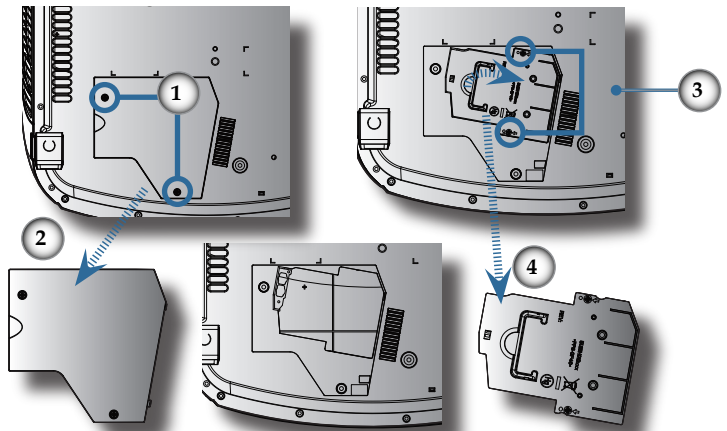

Warning: To reduce the risk of personal injury, do not drop the lamp module or touch the lamp bulb. The bulb may shatter and cause injury if it is dropped.

### Lamp Replacing Procedure:

1. Switch off the power to the projector by pressing the Power button.
2. Allow the projector to cool down at least 30 minutes.
3. Disconnect the power cord.
4. Use a screwdriver to remove the screw from the cover. ❶
5. Push up and remove the cover. ❷
6. Remove the 2 screws from the lamp module. ❸
7. Pull out the lamp module. ❹

To replace the lamp module, reverse the previous steps.

8. Turn on the projector and do "Lamp Reset" after the lamp module is replaced.

Lamp Reset: (i) Press "Menu" -> (ii) Select "Options" -> (iii) Select "Lamp Settings" -> (iv) Select "Lamp Reset" -> (v) Select "Yes".

## Compatibility Modes

Mode	Resolution	V.Frequency (Hz)	Analog	Digital	
VESA VGA	640 x 350	70	✗	✓	
	640 x 400	85	✓	✓	
	640 x 480	60	✓	✓	
	640 x 480	72	✓	✓	
	640 x 480	75	✓	✓	
	640 x 480	85	✓	✗	
	720 x 400	70	✗	✓	
VESA SVGA	720 x 400	85	✓	✗	
	800 x 600	56	✓	✓	
	800 x 600	60	✓	✓	
	800 x 600	72	✓	✓	
	800 x 600	75	✓	✓	
VESA XGA	800 x 600	85	✓	✓	
	1024 x 768	60	✓	✓	
	1024 x 768	70	✓	✓	
	1024 x 768	75	✓	✓	
VESA WXGA	1024 x 768	85	✓	✓	
	HD	1280 x 720	60	✓	✓
	VESA SXGA	1280 x 720	60	✓	✓
		1280 x 768	60	✓	✓
		1280 x 768	70	✓	✗
1280 x 768		85	✓	✗	
VESA SXGA+	1280 x 800	60	✓	✓	
	1152 x 864	60	✓	✓	
	1152 x 864	70	✓	✓	
	1152 x 864	75	✓	✓	
	1152 x 864	85	✓	✓	
	1280 x 1024	60	✓	✓	
VESA UXGA	1280 x 1024	75	✓	✓	
	VESA SXGA+	1400 x 1050	60	✓	✓
HD	VESA WSXGA+	1680 x 1050	60	✓	✓
	VESA UXGA	1600 x 1200	60	✓	✓
UWXGA	HD	1920 x 1080	24	✗	✓
	HD	1920 x 1080	60	✓	✓
	UWXGA	1920 x 1200	60	✓	✓



For widescreen resolution (WXGA), the compatibility support is dependent on Notebook/PC models.

## RS232 Commands and Protocol Function List

### RS232 Pin Assignments

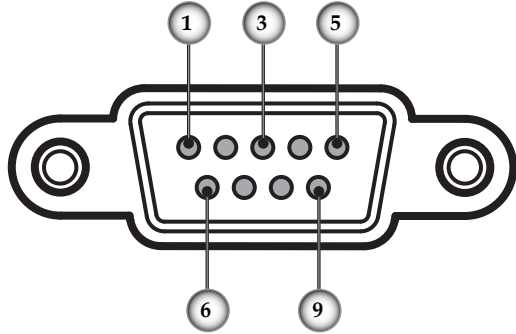

Pin no.	Name	I/O (From Projector Side)
1	NC	—
2	RXD	IN
3	TXD	OUT
4	NC	—
5	NC	—
6	NC	—
7	RS232	—
8	RS232	—
9	NC	—

## RS232 Protocol Function List

### Optoma RS232 Command Table for EP1080

Baud Rate : 9600

Data Bits : 8

Parity : None

Stop Bits : 1

Flow Control : None

UART16550 FIFO: Disable

Projector Return (Pass): P + <CR>

Projector Return (Fail): F + <CR>

XX=01-99, projector's ID, XX=00 is for all projectors

All numerical digits in command parameters are in "ASCII" text format (ex. n = 1 → Code: "1"=31H)

### SEND to projector

32 ASCII Code	HEX Code	Function	Description
~XX00 n	7E 30 30 30 20 a 0D	Power Control	n = 1 Power ON (a=31) 2 Power OFF (a=32)
~XX00 1 ~nmn		Power On with Password	
~XX01 1	7E 30 30 30 31 20 31 0D	Resync	
~XX02 n	7E 30 30 30 32 20 a 0D	AV Mute	n = 1 AV Mute On (a=31) 2 AV Mute Off (a=32)
~XX03 n	7E 30 30 30 33 20 a 0D	Mute	n = 1 Mute On (a=31) 2 Mute Off (a=32)
~XX04 1	7E 30 30 30 34 20 a 0D	Freeze control	n = 1 Freeze (a=31) 2 Unfreeze (a=32)
~XX05 1	7E 30 30 30 35 20 31 0D	Zoom Plus (Zoom in)	
~XX06 1	7E 30 30 30 36 20 31 0D	Zoom Minus (Zoom out)	
~XX12 n	7E 30 30 31 32 20 a 0D	Direct Source Selection	n = 1 HDMI (a=31, 32, 35, ...) 2 DVI-D 5 VGA 1 6 VGA 2 7 VGA 1 SCART 8 VGA 1 Component 9 S-Video 10 Video 12 VGA 2 SCART 13 VGA 2 Component
~XX20 n	7E 30 30 32 30 20 a 0D	Display Mode	n = 1 Presentation (a=31, 32, 33, 34, 35, 36) 2 Bright 3 Movie 4 sRGB 5 User 1 6 User 2
~XX21 n	7E 30 30 32 31 20 a 0D	Brightness	n = 000 (a= 30 30 30) ~ +100 (a= 31 30 30)
~XX22 n	7E 30 30 32 32 20 a 0D	Contrast	n = 000 (a= 30 30 30) ~ +100 (a= 31 30 30)
~XX23 n	7E 30 30 32 33 20 a 0D	Sharpness	n = 0 (a= 30 ) ~ +15 (a= 31 35)
~XX35 n	7E 30 30 33 35 20 a 0D	Degamma	n = 1 Film (a=31, 32, 33, 34) 2 Video 3 Graphics 4 sRGB
~XX36 n	7E 30 30 33 36 20 a 0D	Color Temp.	n = 1 Warm (a=31, 32, 33) 2 Medium 3 Cold
~XX37 n	7E 30 30 33 37 20 a 0D	Color Space	n = 1 Auto (a=31, 32, 33) 2 RGB 3 YUV
~XX39 n	7E 30 30 33 39 20 a 0D	Input Source	n = 1 HDMI (a=31, 32, 35, ...) 2 DVI-D 5 VGA 1 6 VGA 2 7 VGA 1 SCART 8 VGA 1 Component 9 S-Video 10 Video 12 VGA 2 SCART 13 VGA 2 Component
~XX44 n	7E 30 30 31 39 31 20 a 0D	Tint	n = 000 (a= 30 30 30) ~ +100 (a= 31 30 30)
~XX45 n	7E 30 30 31 39 30 20 a 0D	Color	n = 000 (a= 30 30 30) ~ +100 (a= 31 30 30)
~XX60 1	7E 30 30 36 30 20 a 0D	Display Format	n = 1 4:3 (a=31, 32, 35, 36) 2 16:9 5 LBX 6 Native
~XX61 n	7E 30 30 36 31 20 a 0D	Oversca	n = 0 (a= 30) ~ 5 (a= 35)
~XX62 n	7E 30 30 36 32 20 a 0D	Zoom	n = 0 (a= 30) ~ 43 (a= 34 33)

# Appendices

-XX63 n	7E 30 30 36 33 20 a 0D	Image Shift Right / Left	n= 1/2 (a = 31/32)
-XX64 n	7E 30 30 36 34 20 a 0D	Image Shift Up / Down	n= 1/2 (a = 31/32)
-XX66 n	7E 30 30 36 36 20 a 0D	Keystone Up / Down	n= 1/2 (a = 31/32)
-XX70 n	7E 30 30 37 30 20 a 0D	Language	n = 1 English (a=31, 32, 33, ...) 2 German 3 French 4 Italian 5 Spanish 6 Portuguese 7 Polish 8 Dutch 9 Swedish 10 Norwegian/Danish 11 Finnish 12 Greek 13 Traditional Chinese 14 Simplified Chinese 15 Japanese 16 Korean 17 Russian 18 Hungarian 19 Czechoslovak 20 Arabic
-XX71 n	7E 30 30 37 31 20 a 0D	Projection	n = 1 Front-Desktop (a=31, 32, 33, ...) 2 Rear-Desktop 3 Front-Ceiling 4 Rear-Ceiling
-XX72 n	7E 30 30 37 32 20 a 0D	Menu Location	n = 1 Top Left (a=31, 32, 33, ...) 2 Top Right 3 Centre 4 Bottom Left 5 Bottom Right
-XX73 n	7E 30 30 37 33 20 a 0D	Tracking	n=000 (a= 30 30 30) ~ +200 (a= 32 30 30) Each step adds 10
-XX74 n	7E 30 30 37 34 20 a 0D	Phase	n=000 (a= 30 30 30) ~ 100 (a= 31 30 30)
-XX75 n	7E 30 30 37 35 20 a 0D	Position Right / Left	n= 1/2 (a = 31/32)
-XX76 l	7E 30 30 37 36 20 a 0D	Position Up / Down	n= 1/2 (a = 31/32)
-XX77 n	7E 30 30 37 37 20 31mmddhh 0D	Security	Security Timer Month/Day/Hour n=mmddhh mm= 00 (aa=30 30) ~ 12 (aa=31 32) dd = 00 (aa=30 30) ~ 31 (aa=33 31) hh = 00 (aa=30 30) ~ 24 (aa=32 34)
-XX78 n	7E 30 30 37 38 20 a 0D	Security Settings	n = 1 Security On (a=31, 32) 2 Security Off
-XX79 n	7E 30 30 37 39 20 a 0D	Projector ID	n= 00 (a=30 30) ~99 (a=39 39)
-XX80 n	7E 30 30 38 30 20 a 0D	Mute	n = 1 Mute On (a=31, 32) 2 Mute Off
-XX81 n	7E 30 30 38 31 20 31 a 0D	Volume	n=0 (a=30) ~ 15 (a=31 35)
-XX82 n	7E 30 30 38 32 20 a 0D	Logo	n = 1 Optoma (a=31, 32) 2 User
-XX83 n	7E 30 30 38 33 20 a 0D	Logo Capture	
-XX100 n	7E 30 30 31 30 30 20 a 0D	Source Lock	n = 1 On (a=31, 32) 2 Off
-XX101 n	7E 30 30 31 30 31 20 a 0D	High Altitude	n = 1 On (a=31, 32) 2 Off
-XX102 n	7E 30 30 31 30 32 20 a 0D	Information Hide	n = 1 On (a=31, 32) 2 Off
-XX103 n	7E 30 30 31 30 33 20 a 0D	Keypad Lock	n = 1 On (a=31, 32) 2 Off
-XX104 n	7E 30 30 31 30 34 20 a 0D	Background Color	n = 1 Blue (a=31, 32, 33, 34, 35) 2 Black 3 Red 4 Green 5 White
-XX105 n	7E 30 30 31 30 35 20 a 0D	Advanced	Direct Power On n = 1 On (a=31, 32) 2 Off
-XX113 n	7E 30 30 31 31 35 20 a 0D		Signal Power On n = 1 On (a=31, 32) 2 Off
-XX106 n	7E 30 30 31 30 36 20 a 0D		Auto Power Off (min) n= 0 (a= 30) ~ 60 (a= 36 30) Each step adds 5
-XX107 n	7E 30 30 31 30 37 20 a 0D		Sleep Timer (min) n= 0 (a= 30) ~ 60 (a= 36 30) Each step adds 5
-XX108 l	7E 30 30 31 30 38 20 31 0D	Lamp Setting	Lamp Hour
-XX109 n	7E 30 30 31 30 39 20 a 0D		Lamp Reminder n = 1 On (a=31, 32) 2 Off
-XX110 n	7E 30 30 31 31 30 20 a 0D		Brightness Mode n = 1 Bright (a=31, 32)

-XX111 n 7E 30 30 31 31 31 20 a 0D Lamp Reset n = 1 2 STD  
n = 1 Yes (a=31, 32)  
2 No

-XX112 n 7E 30 30 31 31 32 20 a 0D Reset n = 1 Yes (a=31, 32)  
2 No

## Virtual remote console to projector

32 ASCII Code	HEX Code	Function	Description
-XX140 n	7E 30 30 31 34 30 20 a 0D	n = 1 Power 2 Re-sync 3 Keystone 4 AV Mute 5 Freeze 6 Display 7 Zoom in 8 Zoom out 9 Volume + 10 Volume - 11 Enter (for projection MENU) 12 Menu 13 Left 14 Up 15 Right 16 Down 18 Format (1) 19 PIP (2) 20 Swap (3) 21 SRC (4) 22 DVI (5) 23 Video (6) 24 VGA-1 (7) 25 HDMI (8) 26 S-Video (9) 27 VGA-2 (0)	(a=31, 32, 33, ...)

## SEND from projector automatically

32 ASCII Code	HEX Code	Function	Projector Return	Description
When in: Standby/Warming/Cooling/Out of range/Lamp fail Temperature fail/ Thermal error			INFO n	n : 0/1/2/3/4 = Standby/Warming/Cooling/Out of Range/Lamp Fail 5/6 / Temperature fail / Thermal error

## READ from projector

32 ASCII Code	HEX Code	Function	Projector Return	Description
-XX121 1	7E 30 30 31 32 31 20 31 0D	Input Source Commands	OKaa	aa : 01/02/04/05/06/07/08=HDMI/DVI/VGA1/VGA2/Video/ S-Video
-XX122 1	7E 30 30 31 32 32 20 31 0D	Software Version	OKaaa	
-XX123 1	7E 30 30 31 32 33 20 31 0D	Display Mode	OKa	a : 1/2/3/4/5/6=Presentation/Bright/Movie/sRGB/User1/User2
-XX124 1	7E 30 30 31 32 34 20 31 0D	Power State	OKa	a : 1/0=On/Off
-XX125 1	7E 30 30 31 32 35 20 31 0D	Brightness	OKn	n : 000 to 100
-XX126 1	7E 30 30 31 32 36 20 31 0D	Contrast	OKn	n : 000 to 100
-XX127 1	7E 30 30 31 32 37 20 31 0D	Aspect Ratio	OKa	a : 0/1/2/3=4:3 / 16:9 / LBX / Native
-XX128 1	7E 30 30 31 32 38 20 31 0D	Color Temperature	OKa	a : 0/1/2=Warm/Medium/Cold
-XX129 1	7E 30 30 31 32 39 20 31 0D	Projection Mode	OKa	a : 0/1/2/3=Front-Desktop/Rear-Desktop / Front-Ceiling/Rear-Ceiling
-XX150 1	7E 30 30 31 35 30 20 31 0D	Information	OKabbbccddde	a : 1/0=On/Off bbbb: Lamp Hour cc: source 00/01/02/03/04/05/07= None/DVI/VGA1/VGA2/S-Video/Video/HDMI dddd: FW version e : Display mode 0/1/2/3/4/5/6=None/Presentation/Bright/Movie/sRGB/User1/User2 n : 0 EP1080
-XX151 1	7E 30 30 31 35 31 20 31 0D	Model name	OKn	

## Ceiling Mount Installation

1. To prevent damage to your projector, please use the Optoma ceiling mount.
2. If you wish to use a third party ceiling mount kit, please ensure the screws used to attached a mount to the projector met the following specifications:

- ▶ **Screw type: M4**
- ▶ **Maximum screw length: 10mm**
- ▶ **Minimum screw length: 8mm**

### Note

Please note that damage resulting from incorrect installation will invalidate the warranty.



### Warning:

1. If you buy ceiling mount from other company, please be sure to use the correct screw size. Screw size will be different on different mounts. It depends on the plate thickness.
2. Be sure to keep at least 10cm gap between the ceiling and the bottom of the projector.
3. Avoid installing the projector near a heat source.

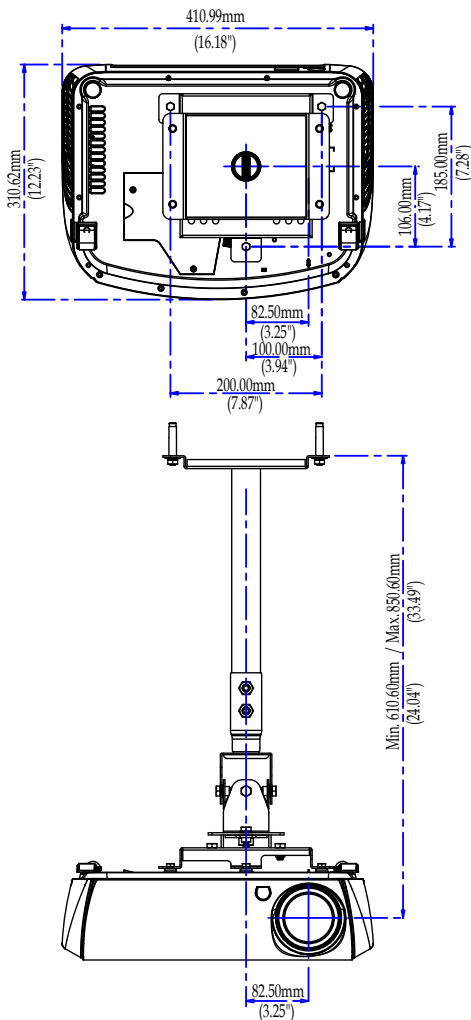



## Optoma Global Offices

*For service or support please contact your local office.*

### USA

715 Sycamore Drive  
Milpitas, CA 95035, USA  
[www.optomausa.com](http://www.optomausa.com)

Tel : 408-383-3700  
Fax: 408-383-3702  
Service : [services@optoma.com](mailto:services@optoma.com)

### Canada

5630 Kennedy Road, Mississauga,  
ON, L4Z 2A9, Canada  
[www.optoma.ca](http://www.optoma.ca)

Tel : 905-361-2582  
Fax: 905-361-2581

### Europe

42 Caxton Way, The Watford Business Park  
Watford, Hertfordshire,  
WD18 8QZ, UK  
[www.optoma.eu](http://www.optoma.eu)

Service Tel : +44 (0)1923 691865

Tel : +44 (0) 1923 691 800  
Fax: +44 (0) 1923 691 888  
Service : [service@tsc-europe.com](mailto:service@tsc-europe.com)

### France

Bâtiment E  
81-83 avenue Edouard Vaillant  
92100 Boulogne Billancourt, France

Tel : +33 1 41 46 12 20  
Fax: +33 1 41 46 94 35  
Service : [savoptoma@optoma.fr](mailto:savoptoma@optoma.fr)

### Spain

C/ José Hierro,36 Of. 1C  
28529 Rivas VaciaMadrid,  
Spain

Tel : +34 91 499 06 06  
Fax: +34 91 670 08 32

### Deutschland

Werftstrasse 25  
D40549 Düsseldorf,  
Germany

Tel : +49 (0) 211 506 6670  
Fax: +49 (0) 211 506 66799  
Service : [info@optoma.de](mailto:info@optoma.de)

### Scandinavia

Grev Wedels Plass 2  
3015 Drammen  
Norway

Tel : +47 32 26 89 90  
Fax: +47 32 83 78 98  
Service : [info@optoma.de](mailto:info@optoma.de)

### Latin America

715 Sycamore Drive  
Milpitas, CA 95035, USA  
[www.optoma.com.br](http://www.optoma.com.br)

Tel : 408-383-3700  
Fax: 408-383-3702  
[www.optoma.com.mx](http://www.optoma.com.mx)

# Appendices

---

## Taiwan

231,台北縣新店市民權路108號5樓

R.O.C.

電話：+886-2-2218-2360

服務處：services@optoma.com.tw

傳真：+886-2-2218-2313

www.optoma.com.tw

asia.optoma.com

---

## Hong Kong

Unit A, 27/F Dragon Centre, 79 Wing Hong Street,

Cheung Sha Wan Kowloon, Hong Kong

Tel : +852-2396-8968

www.optoma.com.hk

Fax: +852-2370-1222

---

## China

上海市長宁区凱旋路1205号5樓

邮编：200052

www.optoma.com.cn

电话：+86-21-62947376

传真：+86-21-62947375

---

## Japan

東京都足立区綾瀬 3-25-18

株式会社オーエスエム

E-Mail: info@osscreen.com

サポートセンター:0120-46-5040

http://www.os-worldwide.com/

---

## Korea

WOOMI TECH.CO.,LTD.

4F, Minu Bldg.33-14, Nonhyun-Dong,

Kangnam-Ku, seoul, 135-815, KOREA

Tel : +82+2+34430004

Fax: +82+2+34430005

---

## Regulation & Safety Notices

*This appendix lists the general notices of your Projector.*

### *FCC notice*

This device has been tested and found to comply with the limits for a Class B digital device pursuant to Part 15 of the FCC rules. These limits are designed to provide reasonable protection against harmful interference in a residential installation. This device generates, uses and can radiate radio frequency energy and, if not installed and used in accordance with the instructions, may cause harmful interference to radio communications.

However, there is no guarantee that interference will not occur in a particular installation. If this device does cause harmful interference to radio or television reception, which can be determined by turning the device off and on, the user is encouraged to try to correct the interference by one or more of the following measures:

- Reorient or relocate the receiving antenna.
- Increase the separation between the device and receiver.
- Connect the device into an outlet on a circuit different from that to which the receiver is connected.
- Consult the dealer or an experienced radio/television technician for help.

### ***Notice: Shielded cables***

All connections to other computing devices must be made using shielded cables to maintain compliance with FCC regulations.

### ***Caution***

Changes or modifications not expressly approved by the manufacturer could void the user's authority, which is granted by the Federal Communications Commission, to operate this projector.

# Appendices

## *Operation conditions*

This device complies with Part 15 of the FCC Rules. Operation is subject to the following two conditions:

1. This device may not cause harmful interference and
2. This device must accept any interference received, including interference that may cause undesired operation.

## *Notice: Canadian users*

This Class B digital apparatus complies with Canadian ICES-003.

## *Remarque à l'intention des utilisateurs canadiens*

Cet appareil numérique de la classe B est conforme à la norme NMB-003 du Canada.

## *Declaration of Conformity for EU countries*

- EMC Directive 2004/108/EC (including amendments)
- Low Voltage Directive 2006/95/EC
- R & TTE Directive 1999/5/EC (if product has RF function)

## **Disposal instructions**



**Do not throw this electronic device into the trash when discarding. To minimize pollution and ensure utmost protection of the global environment, please recycle it.**